

Programmable Controller

**MELSEC iQ-F**  
series

**MELSEC iQ-F FX5  
Motion Module/  
Simple Motion Module  
User's Manual (Advanced Synchronous Control)**

---

-FX5-40SSC-G  
-FX5-80SSC-G  
-FX5-40SSC-S  
-FX5-80SSC-S





# SAFETY PRECAUTIONS

---

(Read these precautions before use.)

Before using this product, please read this manual and the relevant manuals introduced in this manual carefully and pay full attention to safety in order to handle the product correctly.

If the equipment is used in a manner not specified by the manufacturer, the protection provided by the equipment may be impaired.

This manual classifies the safety precautions into two categories: [  WARNING] and [  CAUTION].



## WARNING

Indicates that incorrect handling may cause hazardous conditions, resulting in death or severe injury.



## CAUTION

Indicates that incorrect handling may cause hazardous conditions, resulting in minor or moderate injury or property damage.

Depending on the circumstances, procedures indicated by [  CAUTION] may also cause severe injury.

It is important to follow all precautions for personal safety.

Store this manual in a safe place so that it can be read whenever necessary. Always forward it to the end user.

## [DESIGN PRECAUTIONS]

---

### **WARNING**

---

- Make sure to set up the following safety circuits outside the PLC to ensure safe system operation even during external power supply problems or PLC failure. Otherwise, malfunctions may cause serious accidents.
    - Most importantly, set up the following: an emergency stop circuit, a protection circuit, an interlock circuit for opposite movements (such as normal vs. reverse rotation), and an interlock circuit (to prevent damage to the equipment at the upper and lower positioning limits).
    - Note that when the CPU module detects an error, such as a watchdog timer error, during self-diagnosis, all outputs are turned off. Also, when an error that cannot be detected by the CPU module occurs in an input/output control block, output control may be disabled. External circuits and mechanisms should be designed to ensure safe machinery operation in such a case.
    - Note that the output current of the 24 V DC service power supply varies depending on the model and the absence/presence of extension modules. If an overload occurs, the voltage automatically drops, inputs in the PLC are disabled, and all outputs are turned off. External circuits and mechanisms should be designed to ensure safe machinery operation in such a case.
    - Note that when an error occurs in a relay, transistor or triac of an output circuit, the output might stay on or off. For output signals that may lead to serious accidents, external circuits and mechanisms should be designed to ensure safe machinery operation in such a case.
  - Construct an interlock circuit in the program so that the whole system always operates on the safe side before executing the control (for data change) of the PLC in operation.

Read the manual thoroughly and ensure complete safety before executing other controls (for program change, parameter change, forcible output and operation status change) of the PLC in operation. Otherwise, the machine may be damaged and accidents may occur due to erroneous operations.
  - In an output circuit, when a load current exceeding the current rating or an overcurrent caused by a load short-circuit flows for a long time, it may cause smoke and fire. To prevent this, configure an external safety circuit, such as a fuse.
  - For the operating status of each station after a communication failure of the network, refer to relevant manuals for the network. Incorrect output or malfunction may result in an accident.
  - Especially, in the case of a control from an external device to a remote programmable controller, immediate action cannot be taken for a problem on the programmable controller due to a communication failure. Determine the handling method as a system when communication failure occurs along with configuration of interlock circuit on a program, by considering the external equipment and CPU module.
  - Do not write any data to the "system area" and "write-protect area" of the buffer memory in the module. Executing data writing to the "system area" or "write protect area" may cause malfunction of the programmable controller alarm. For the "system area" or "write-protect area", refer to "Buffer Memory" in MELSEC iQ-F FX5 Motion Module User's Manual (CC-Link IE TSN).
  - If a communication cable is disconnected, the network may be unstable, resulting in a communication failure of multiple stations. Construct an interlock circuit in the program so that the system always operates on the safe side even if communications fail. Incorrect output or malfunction may result in an accident.
-

---

## **WARNING**

### [Precautions for using products in a UL/cUL Class I, Division 2 environment]

- Products\*<sup>1</sup> with the Cl.I, DIV.2 mark on the rating plate are suitable for use in Class I, Division 2, Groups A, B, C and D hazardous locations, or nonhazardous locations only.

This mark indicates that the product is certified for use in the Class I, Division 2 environment where flammable gases, vapors, or liquids exist under abnormal conditions. When using the products in the Class I, Division 2 environment, observe the following conditions to reduce the risk of explosion.

- This device is open-type and is to be installed in an enclosed area under suitable environment which requires a tool or key to open.
- Warning - Explosion Hazard - Substitution of any component may impair suitability for Class I, Division 2.
- Warning - Explosion Hazard - Do not disconnect equipment while the circuit is live or unless the area is known to be free of ignitable concentrations.
- Do not open the cover of the CPU module and remove the battery unless the area is known to be nonhazardous.

---

\*1 Products conforming to the UL explosion-proof standard are as follows.

Manufactured in October 2017 onwards

· FX5 CPU module

FX5UC-32MT/D, FX5UC-32MT/DSS, FX5UC-64MT/D, FX5UC-64MT/DSS, FX5UC-96MT/D, FX5UC-96MT/DSS

· FX5 extension module

FX5-C16EX/D, FX5-C16EX/DS, FX5-C16EYT/D, FX5-C16EYT/DSS, FX5-C32EX/D, FX5-C32EX/DS, FX5-C32EYT/D, FX5-C32EYT/DSS, FX5-C32ET/D, FX5-C32ET/DSS, FX5-232ADP, FX5-485ADP, FX5-C1PS-5V, FX5-CNV-BUSC, FX5-4AD-ADP, FX5-4DA-ADP

### [DESIGN PRECAUTIONS]

---

## **CAUTION**

- When an inductive load such as a lamp, heater, or solenoid valve is controlled, a large current (approximately ten times greater than normal) may flow when the output is turned from off to on. Take proper measures so that the flowing current does not exceed the value corresponding to the maximum load specification of the resistance load.
- After the CPU module is powered on or is reset, the time taken to enter the RUN status varies depending on the system configuration, parameter settings, and/or program size.  
Design circuits so that the entire system will always operate safely, regardless of this variation in time.
- Simultaneously turn on and off the power supplies of the CPU module and extension modules.
- If a long-time power failure or an abnormal voltage drop occurs, the PLC stops, and output is turned off. When the power supply is restored, it will automatically restart (when the RUN/STOP/RESET switch is on RUN side).

---

### [SECURITY PRECAUTIONS]

---

## **WARNING**

- To maintain the security (confidentiality, integrity, and availability) of the programmable controller and the system against unauthorized access, denial-of-service (DoS) attacks, computer viruses, and other cyberattacks from unreliable networks and devices via network, take appropriate measures such as firewalls, virtual private networks (VPNs), and antivirus solutions.
-

## [INSTALLATION PRECAUTIONS]

---

### **WARNING**

- Make sure to cut off all phases of the power supply externally before attempting installation or wiring work. Failure to do so may cause electric shock or damage to the product.
  - Use the product within the generic environment specifications described in the generic specifications of the user's manual (Hardware) of the CPU module to use.  
Never use the product in areas with excessive dust, oily smoke, conductive dusts, corrosive gas (salt air, Cl<sub>2</sub>, H<sub>2</sub>S, SO<sub>2</sub> or NO<sub>2</sub>), flammable gas, vibration or impacts, or expose it to high temperature, condensation, or rain and wind.  
If the product is used in such conditions, electric shock, fire, malfunctions, deterioration or damage may occur.
- 

## [INSTALLATION PRECAUTIONS]

---

### **CAUTION**

- Do not touch the conductive parts of the product directly. Doing so may cause equipment failures or malfunctions.
  - When drilling screw holes or wiring, make sure that cutting and wiring debris do not enter the ventilation slits of the PLC. Failure to do so may cause fire, equipment failures or malfunctions.
  - For product supplied together with a dust proof sheet, the sheet should be affixed to the ventilation slits before the installation and wiring work to prevent foreign objects such as cutting and wiring debris.  
However, when the installation work is completed, make sure to remove the sheet to provide adequate ventilation. Failure to do so may cause fire, equipment failures or malfunctions.
  - Install the product on a flat surface. If the mounting surface is rough, undue force will be applied to the PC board, thereby causing nonconformities.
  - Install the product securely using a DIN rail or mounting screws.
  - Connect the expansion board and expansion adapter securely to their designated connectors. Loose connections may cause malfunctions.
  - Make sure to affix the expansion board with tapping screws. Tightening torque should follow the specifications in the user's manual (Hardware) of the CPU module to use. If the screws are tightened outside of the specified torque range, poor connections may cause malfunctions.
  - Work carefully when using a screwdriver such as installation of the product. Failure to do so may cause damage to the product or accidents.
  - Connect the extension cables, peripheral device cables, input/output cables and battery connecting cable securely to their designated connectors. Loose connections may cause malfunctions.
  - When using an SD memory card, insert it into the SD memory card slot. Check that it is inserted completely. Poor contact may cause malfunction.
  - Turn off the power to the PLC before attaching or detaching the following devices. Failure to do so may cause equipment failures or malfunctions.
    - Peripheral devices, expansion board, expansion adapter, and connector conversion adapter
    - Extension modules, bus conversion module, and connector conversion module
    - Battery
-

## [WIRING PRECAUTIONS]

---

### **WARNING**

- Make sure to cut off all phases of the power supply externally before attempting installation or wiring work. Failure to do so may cause electric shock or damage to the product.
  - Make sure to attach the terminal cover, provided as an accessory, before turning on the power or initiating operation after installation or wiring work. Failure to do so may cause electric shock.
  - The temperature rating of the cable should be 80°C or more.  
It may differ depending on the extension devices. Refer to the user's manual (Hardware) of the extension device to use for the details.
  - Make sure to wire the screw terminal block in accordance with the following precautions. Failure to do so may cause electric shock, equipment failures, a short-circuit, wire breakage, malfunctions, or damage to the product.
    - The disposal size of the cable end should follow the dimensions described in the user's manual (Hardware) of the CPU module to use.
    - Tightening torque should follow the specifications in the user's manual (Hardware) of the CPU module to use.
    - Tighten the screws using a Phillips-head screwdriver No. 2 (shaft diameter 6 mm (0.24") or less). Make sure that the screwdriver does not touch the partition part of the terminal block.
  - Make sure to properly wire to the terminal block (European type) in accordance with the following precautions. Failure to do so may cause electric shock, equipment failures, a short-circuit, wire breakage, malfunctions, or damage to the product.
    - The disposal size of the cable end should follow the dimensions described in the user's manual (Hardware) of the CPU module to use.
    - Tightening torque should follow the specifications in the user's manual (Hardware) of the CPU module to use.
    - Twist the ends of stranded wires and make sure that there are no loose wires.
    - Do not solder-plate the electric wire ends.
    - Do not connect more than the specified number of wires or electric wires of unspecified size.
    - Affix the electric wires so that neither the terminal block nor the connected parts are directly stressed.
  - Make sure to properly wire to the spring clamp terminal block in accordance with the following precautions. Failure to do so may cause electric shock, equipment failures, a short-circuit, wire breakage, malfunctions, or damage to the product.
    - The disposal size of the cable end should follow the dimensions described in the user's manual (Hardware) of the CPU module to use.
    - Twist the ends of stranded wires and make sure that there are no loose wires.
    - Do not solder-plate the electric wire ends.
    - Do not connect more than the specified number of wires or electric wires of unspecified size.
    - Affix the electric wires so that neither the terminal block nor the connected parts are directly stressed.
-

## [WIRING PRECAUTIONS]

---

### CAUTION

- Do not supply power to the [24 +] and [24 V] terminals (24 V DC service power supply) on the CPU module or extension modules. Doing so may cause damage to the product.
  - Perform class D grounding (grounding resistance: 100  $\Omega$  or less) of the grounding terminal on the CPU module and extension modules with a wire 2 mm<sup>2</sup> or thicker.  
Do not use common grounding with heavy electrical systems. Refer to the user's manual (Hardware) of the CPU module to use for the details.
  - Connect the power supply wiring to the dedicated terminals described in the user's manual (Hardware) of the CPU module to use. If an AC power supply is connected to a DC input/output terminal or DC power supply terminal, the PLC will burn out.
  - Do not wire vacant terminals externally. Doing so may damage the product.
  - Install module so that excessive force will not be applied to terminal blocks, power connectors, I/O connectors, communication connectors, or communication cables. Failure to do so may result in wire damage/breakage or PLC failure.
  - Make sure to observe the following precautions in order to prevent any damage to the machinery or accidents due to malfunction of the PLC caused by abnormal data written to the PLC due to the effects of noise.
    - Do not bundle the power line, control line and communication cables together with or lay them close to the main circuit, high-voltage line, load line or power line. As a guideline, lay the power line, control line and communication cables at least 100 mm (3.94") away from the main circuit, high-voltage line, load line or power line.
    - Ground the shield of the shield wire or shielded cable at one point on the PLC. However, do not use common grounding with heavy electrical systems.
    - Ground the shield of the analog input/output cable at one point on the signal receiving side. However, do not use common grounding with heavy electrical systems.
-



## [STARTUP AND MAINTENANCE PRECAUTIONS]

---

### **WARNING**

- Do not touch any terminal while the PLC's power is on. Doing so may cause electric shock or malfunctions.
- Before cleaning or retightening terminals, cut off all phases of the power supply externally. Failure to do so in the power ON status may cause electric shock.
- Before modifying the program in operation, forcible output, running or stopping the PLC, read through the manual carefully, and ensure complete safety. An operation error may damage the machinery or cause accidents.
- Do not change the program in the PLC from two or more peripheral equipment devices at the same time. (i.e. from an engineering tool and a GOT) Doing so may cause destruction or malfunction of the PLC program.
- Use the battery for memory backup in conformance to the user's manual (Hardware) of the CPU module to use.
  - Use the battery for the specified purpose only.
  - Connect the battery correctly.
  - Do not charge, disassemble, heat, put in fire, short-circuit, connect reversely, weld, swallow or burn the battery, or apply excessive forces (vibration, impact, drop, etc.) to the battery.
  - Do not store or use the battery at high temperatures or expose to direct sunlight.
  - Do not expose to water, bring near fire or touch liquid leakage or other contents directly.
  - When replacing the battery, make sure to use our specified product (FX3U-32BL).
  - When a battery error occurs ("BAT" LED is lit in red), follow the description in the user's manual (Hardware) of the CPU module to use.

Incorrect handling of the battery may cause excessive generation, bursting, ignition, liquid leakage or deformation, and lead to injury, fire or failures and malfunction of facilities and other equipment.

---

## [STARTUP AND MAINTENANCE PRECAUTIONS]

---

### **CAUTION**

- Do not disassemble or modify the PLC. Doing so may cause fire, equipment failures, or malfunctions. For repair, contact your local Mitsubishi Electric representative.
  - After the first use of the SD memory card, do not insert/remove the memory card more than 500 times. 500 times or more may cause malfunction.
  - Turn off the power to the PLC before connecting or disconnecting any extension cable. Failure to do so may cause equipment failures or malfunctions.
  - Turn off the power to the PLC before attaching or detaching the following devices. Failure to do so may cause equipment failures or malfunctions.
    - Peripheral devices, expansion board, expansion adapter, and connector conversion adapter
    - Extension modules, bus conversion module, and connector conversion module
    - Battery
  - Do not use the chemicals for cleaning.
  - If there is the possibility of touching the PLC inside a control panel in maintenance, make sure to discharge to avoid the influence of static electricity.
  - Since there are risks such as burn injuries, please do not touch the surface of the equipment with bare hands when it is operating in an environment which exceeds ambient temperature of 50°C.
-

## [OPERATION PRECAUTIONS]

---

### CAUTION

- Construct an interlock circuit in the program so that the whole system always operates on the safe side before executing the control (for data change) of the PLC in operation. Read the manual thoroughly and ensure complete safety before executing other controls (for program change, parameter change, forcible output and operation status change) of the PLC in operation. Otherwise, the machine may be damaged and accidents may occur by erroneous operations.
- 

## [DISPOSAL PRECAUTIONS]

---

### CAUTION

- Please contact a certified electronic waste disposal company for the environmentally safe recycling and disposal of your device.
  - When disposing of batteries, separate them from other waste according to local regulations. For details on the Battery Directive in EU countries, refer to the user's manual (Hardware) of the CPU module to use.
- 

## [TRANSPORTATION PRECAUTIONS]

---

### CAUTION

- When transporting the PLC with the optional battery, turn on the PLC before shipment, confirm that the battery mode is set using a parameter and the BAT LED is OFF, and check the battery life. If the PLC is transported with the BAT LED ON or the battery exhausted, the battery-backed data may be unstable during transportation.
  - The PLC is a precision instrument. During transportation, avoid impacts larger than those specified in the general specifications by using dedicated packaging boxes and shock-absorbing palettes. Failure to do so may cause failures in the PLC. After transportation, verify operation of the PLC and check for damage of the mounting part, etc. For details on the general specifications, refer to the user's manual (Hardware) of the CPU module to use.
  - When transporting lithium batteries, follow required transportation regulations. For details on the regulated products, refer to the user's manual (Hardware) of the CPU module to use.
  - When fumigants that contain halogen materials such as fluorine, chlorine, bromine, and iodine used for disinfecting and protecting wooden packaging from insects, they cause malfunction when entering our products. Please take necessary precautions to ensure that remaining materials from fumigant do not enter our products, or treat packaging with methods other than fumigation (heat method). Additionally, disinfect and protect wood from insects before packing products.
-

# INTRODUCTION

Thank you for purchasing the Mitsubishi Electric MELSEC iQ-F series programmable controllers.

This manual describes the functions and programming of the relevant products listed below. Before using this product, please read this manual and the relevant manuals carefully and develop familiarity with the functions and performance of the MELSEC iQ-F series programmable controller to handle the product correctly.

When applying the program examples provided in this manual to an actual system, ensure the applicability and confirm that it will not cause system control problems.

Please make sure that the end users read this manual.

## Relevant products

FX5-40SSC-S, FX5-80SSC-S, FX5-40SSC-G, FX5-80SSC-G

### Point

Symbols used in this manual are shown below.

A serial No. is inserted in the "\*\*\*\*" mark.

- [Pr.\*\*]: Symbols indicating positioning parameter or home position return parameter items
- [Da.\*\*]: Symbols indicating positioning data or block start data items
- [Md.\*\*]: Symbols indicating monitor data items
- [Cd.\*\*]: Symbols indicating control data items
- [FX5-SSC-S]: Symbols indicating compatibility with only FX5-SSC-S
- [FX5-SSC-G]: Symbols indicating compatibility with only FX5-SSC-G

## Regarding use of this product

- This product has been manufactured as a general-purpose part for general industries, and has not been designed or manufactured to be incorporated in a device or system used in purposes related to human life.
- Before using the product for special purposes such as nuclear power, electric power, aerospace, medicine or passenger movement vehicles, consult Mitsubishi Electric.
- This product has been manufactured under strict quality control. However when installing the product where major accidents or losses could occur if the product fails, install appropriate backup or failsafe functions in the system.

## Note

- If in doubt at any stage during the installation of the product, always consult a professional electrical engineer who is qualified and trained in the local and national standards. If in doubt about the operation or use, please consult the nearest Mitsubishi Electric representative.
- Since the examples indicated by this manual, technical bulletin, catalog, etc. are used as a reference, please use it after confirming the function and safety of the equipment and system. Mitsubishi Electric will accept no responsibility for actual use of the product based on these illustrative examples.
- This manual content, specification etc. may be changed, without a notice, for improvement.
- The information in this manual has been carefully checked and is believed to be accurate; however, if you notice a doubtful point, an error, etc., please contact the nearest Mitsubishi Electric representative. When doing so, please provide the manual number given at the end of this manual.

# CONTENTS

SAFETY PRECAUTIONS .....	1
INTRODUCTION .....	9
RELATED MANUALS .....	12
TERMS .....	13
<b>CHAPTER 1 OUTLINE OF ADVANCED SYNCHRONOUS CONTROL</b> .....	<b>14</b>
<b>1.1 Outline of Synchronous Control</b> .....	<b>15</b>
<b>1.2 Performance Specifications</b> .....	<b>19</b>
<b>1.3 Operation Method of Synchronous Control</b> .....	<b>22</b>
Synchronous control execution procedure .....	22
Starting/ending for synchronous control .....	23
Stop operation of output axis .....	25
<b>CHAPTER 2 INPUT AXIS MODULE</b> .....	<b>27</b>
<b>2.1 Servo Input Axis</b> .....	<b>27</b>
Overview of servo input axis .....	27
Servo input axis parameters .....	29
Servo input axis monitor data .....	32
<b>2.2 Command Generation Axis</b> .....	<b>34</b>
Overview of command generation axis .....	34
Command generation axis parameters .....	38
Command generation axis control data .....	42
Command generation axis monitor data .....	46
Command generation axis positioning data .....	50
Write/read method for command generation axis parameter and positioning data .....	52
<b>2.3 Synchronous Encoder Axis</b> .....	<b>55</b>
Overview of synchronous encoder axis .....	55
Setting method for synchronous encoder .....	59
Synchronous encoder axis parameters .....	68
Synchronous encoder axis control data .....	74
Synchronous encoder axis monitor data .....	77
<b>CHAPTER 3 CAM FUNCTION</b> .....	<b>80</b>
<b>3.1 Control Details for Cam Function</b> .....	<b>80</b>
<b>3.2 Create Cam Data</b> .....	<b>87</b>
Memory configuration of cam data .....	87
Cam data operation function .....	90
Cam auto-generation function .....	93
<b>CHAPTER 4 ADVANCED SYNCHRONOUS CONTROL</b> .....	<b>96</b>
<b>4.1 Main Shaft Module</b> .....	<b>96</b>
Overview of main shaft module .....	96
Main shaft parameters .....	96
Main shaft clutch parameters .....	99
Main shaft clutch control data .....	104
<b>4.2 Auxiliary Shaft Module</b> .....	<b>105</b>
Overview of auxiliary shaft module .....	105
Auxiliary shaft parameters .....	105

Auxiliary shaft clutch parameters . . . . .	107
Auxiliary shaft clutch control data . . . . .	112
<b>4.3 Clutch . . . . .</b>	<b>113</b>
Overview of clutch . . . . .	113
Control method for clutch . . . . .	113
Smoothing method for clutch . . . . .	118
Use example of clutch . . . . .	123
<b>4.4 Speed Change Gear Module . . . . .</b>	<b>124</b>
Overview of speed change gear module . . . . .	124
Speed change gear parameters . . . . .	125
<b>4.5 Output Axis Module . . . . .</b>	<b>126</b>
Overview of output axis module . . . . .	126
Output axis parameters . . . . .	128
<b>4.6 Synchronous Control Change Function . . . . .</b>	<b>131</b>
Overview of synchronous control change function . . . . .	131
Synchronous control change control data . . . . .	131
<b>4.7 Synchronous Control Monitor Data . . . . .</b>	<b>135</b>
<b>4.8 Phase Compensation Function . . . . .</b>	<b>139</b>
<b>4.9 Output Axis Sub Functions . . . . .</b>	<b>141</b>
<b>CHAPTER 5 ADVANCED SYNCHRONOUS CONTROL INITIAL POSITION . . . . .</b>	<b>142</b>
<hr/>	
<b>5.1 Synchronous Control Initial Position . . . . .</b>	<b>142</b>
<b>5.2 Synchronous Control Initial Position Parameters . . . . .</b>	<b>146</b>
<b>5.3 Cam Axis Position Restoration Method . . . . .</b>	<b>149</b>
Cam axis current value per cycle restoration . . . . .	149
Cam reference position restoration . . . . .	155
Cam axis feed current value restoration . . . . .	157
<b>5.4 Synchronous Control Analysis Mode . . . . .</b>	<b>159</b>
<b>5.5 Cam Position Calculation Function . . . . .</b>	<b>161</b>
Cam position calculation control data . . . . .	161
Cam position calculation monitor data . . . . .	163
<b>5.6 Method to Restart Synchronous Control . . . . .</b>	<b>168</b>
<b>APPENDICES . . . . .</b>	<b>169</b>
<hr/>	
<b>Appendix 1 List of Buffer Memory Addresses (for Synchronous Control) . . . . .</b>	<b>169</b>
<b>Appendix 2 Sample Program of Synchronous Control . . . . .</b>	<b>177</b>
Program example [FX5-SSC-S] . . . . .	177
Program example [FX5-SSC-G] . . . . .	181
<b>INDEX . . . . .</b>	<b>186</b>
<hr/>	
REVISIONS . . . . .	188
WARRANTY . . . . .	189
TRADEMARKS . . . . .	190

# RELATED MANUALS

Manual name [manual number]	Description	Available form
MELSEC iQ-F FX5 Motion Module/Simple Motion Module User's Manual (Advanced Synchronous Control) [IB-0300255ENG] (This manual)	Functions and programming for the synchronous control of the Motion module/Simple Motion module	Print book e-Manual PDF
MELSEC iQ-F FX5 Motion Module/Simple Motion Module User's Manual (Startup) [IB-0300251ENG]	Specifications, procedures before operation, system configuration, wiring, and operation examples of the Motion module/Simple Motion module	Print book e-Manual PDF
MELSEC iQ-F FX5 Motion Module/Simple Motion Module User's Manual (Application) [IB-0300253ENG]	Functions, input/output signals, buffer memories, parameter settings, programming, and troubleshooting of the Motion module/Simple Motion module	Print book e-Manual PDF
MELSEC iQ-F FX5 Motion Module User's Manual (CC-Link IE TSN) [IB-0300568ENG]	Functions, parameter settings, troubleshooting, and buffer memories of the CC-Link IE TSN network	Print book e-Manual PDF

This manual does not include detailed information on the followings:

- General specifications
- Available CPU modules and the number of mountable modules
- Installation

For details, refer to the following.

 MELSEC iQ-F FX5U User's Manual (Hardware)

 MELSEC iQ-F FX5UC User's Manual (Hardware)

## Point

e-Manual refers to the Mitsubishi FA electronic book manuals that can be browsed using a dedicated tool.

e-Manual has the following features:

- Required information can be cross-searched in multiple manuals.
- Other manuals can be accessed from the links in the manual.
- The hardware specifications of each part can be found from the product figures.
- Pages that users often browse can be bookmarked.
- Sample programs can be copied to an engineering tool.

# TERMS

Unless otherwise specified, this manual uses the following terms.

Term	Description
4-axis module	Another term for FX5-40SSC-S and FX5-40SSC-G
8-axis module	Another term for FX5-80SSC-S and FX5-80SSC-G
Axis	Another term for a servo amplifier
Buffer memory	A memory in an intelligent function module, where data (such as setting values and monitoring values) are stored. When using the CPU module, the memory is indicated for storing data (such as setting values and monitored values) of the Ethernet function and data used for data communication of the multiple CPU function.
CPU module	The abbreviation for the MELSEC iQ-F series CPU module
Device	A device (X, Y, M, D, or others) in a CPU module
Engineering tool	A generic term for GX Works3 and MR Configurator2
FX5-SSC-G	A generic term for the FX5-40SSC-G and FX5-80SSC-G Simple Motion module
FX5-SSC-S	A generic term for the FX5-40SSC-S and FX5-80SSC-S Simple Motion module
Global label	A label that is enabled for all program data when creating multiple program data in the project. There are two types of global labels: module label that is automatically generated by GX Works3 and label that can be created for the any of the specified devices.
GX Works3	The product name of the software package for the MELSEC programmable controllers (Version 1.005F or later) ([FX5-SSC-S] version 1.007H or later, and [FX5-SSC-G] version 1.072A or later)
Intelligent function module	A module such as the Simple Motion module or Motion module in the MELSEC iQ-F series that has functions other than input and output
Label	A label that represents a device in a given character string
Module label	A label that represents one of memory areas (I/O signals and buffer memory areas) specific to each module in a given character string. GX Works3 automatically generates this label, which can be used as a global label.
Motion module	An abbreviation for the MELSEC iQ-F series Motion module
MR Configurator2	The product name of the setup software for the servo amplifier (Version 1.34L or later) ([FX5-SSC-S] version 1.34L or later, and [FX5-SSC-G] version 1.120A or later)
MR-J3(W)-B	MR-J3-_B_(-RJ)/MR-J3W-_B_ Servo amplifier series
MR-J4(W)-B	MR-J4-_B_(-RJ)/MR-J4W-_B_ Servo amplifier series
MR-J5(W)-G	MR-J5-_G_(-RJ)/MR-J5W-_G_ Servo amplifier series
MR-JE-B(F)	MR-JE-_B_(F) Servo amplifier series
Servo amplifier	A generic term for a drive unit Unless specified in particular, indicates the motor driver unit of the sequential command method which is controlled by the Simple Motion module/Motion module (belonging to own station).
Simple Motion module	The abbreviation for the MELSEC iQ-F series Simple Motion module
SSCNETⅢ*1	High speed synchronous communication network between Simple Motion module and servo amplifier
SSCNETⅢ/H*1	

\*1 SSCNET: Servo System Controller NETwork

# 1 OUTLINE OF ADVANCED SYNCHRONOUS CONTROL

---

The outline, specifications and the operation method of synchronous control using the Simple Motion module/Motion module are explained in this chapter.

This chapter helps to understand what can be done using the positioning system and which procedure to use for a specific purpose.



# 1.1 Outline of Synchronous Control

"Synchronous control" can be achieved using software instead of controlling mechanically with gear, shaft, speed change gear or cam, etc.

"Synchronous control" synchronizes movement with the input axis (servo input axis, command generation axis or synchronous encoder axis), by setting "the parameters for advanced synchronous control" and starting synchronous control on each output axis.

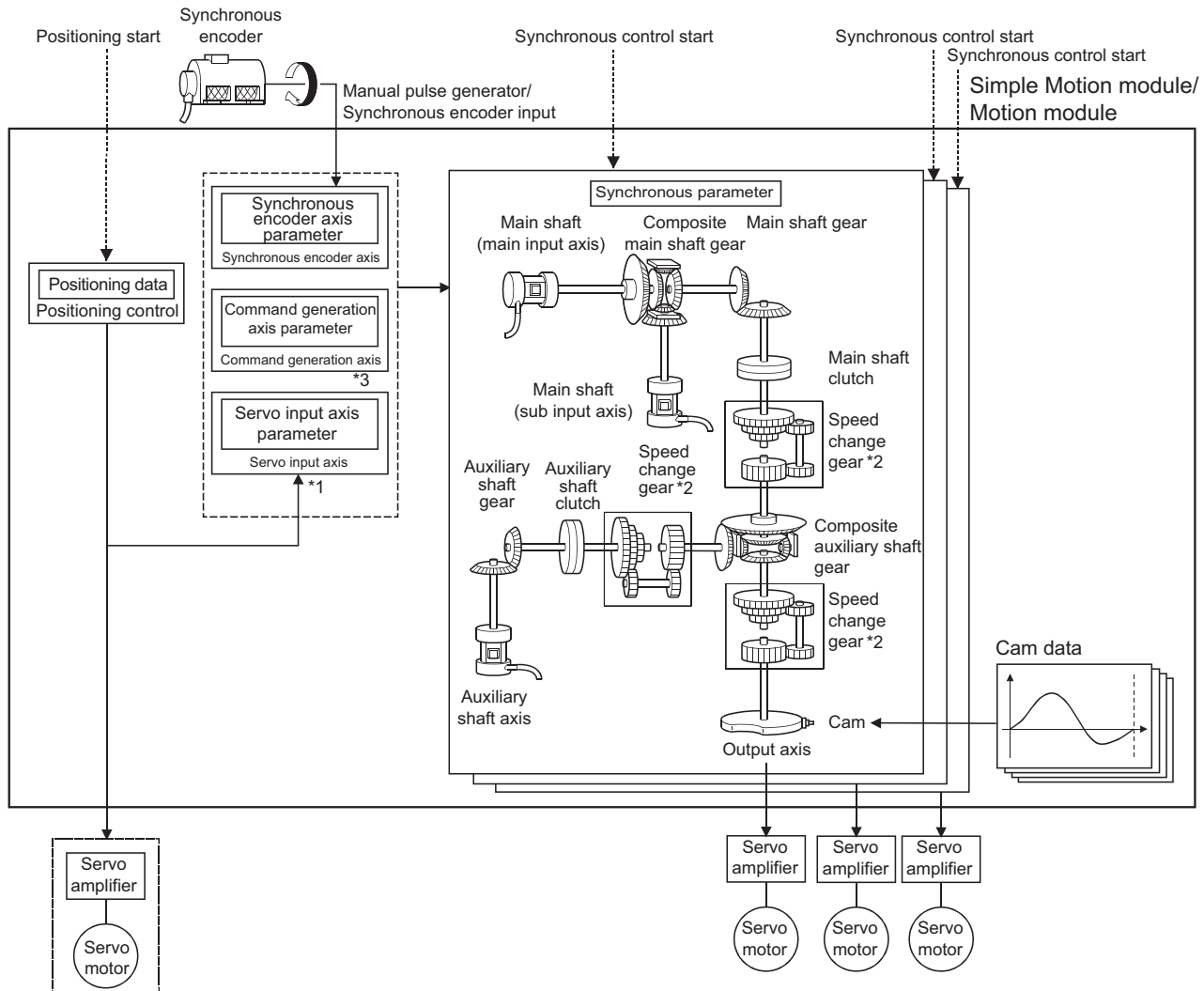

It is possible to control without amplifier by setting the virtual servo amplifier.

\*1 It is possible to drive the servo input axis except for the positioning control (home position return, manual control, speed-torque control, synchronous control).

For details on the positioning control, the home position return, the manual control and the speed-torque control, refer to the following manual.

📖 MELSEC iQ-F FX5 Motion Module/Simple Motion Module User's Manual (Application)

\*2 Speed change gear can be arranged on one of "Main shaft side", "Auxiliary shaft side" or "After composite auxiliary shaft gear".

\*3 For the drive method of the command generation axis, refer to the following.

📄 Page 34 Command Generation Axis

## List of synchronous control module

The module is used in synchronous control as follows.

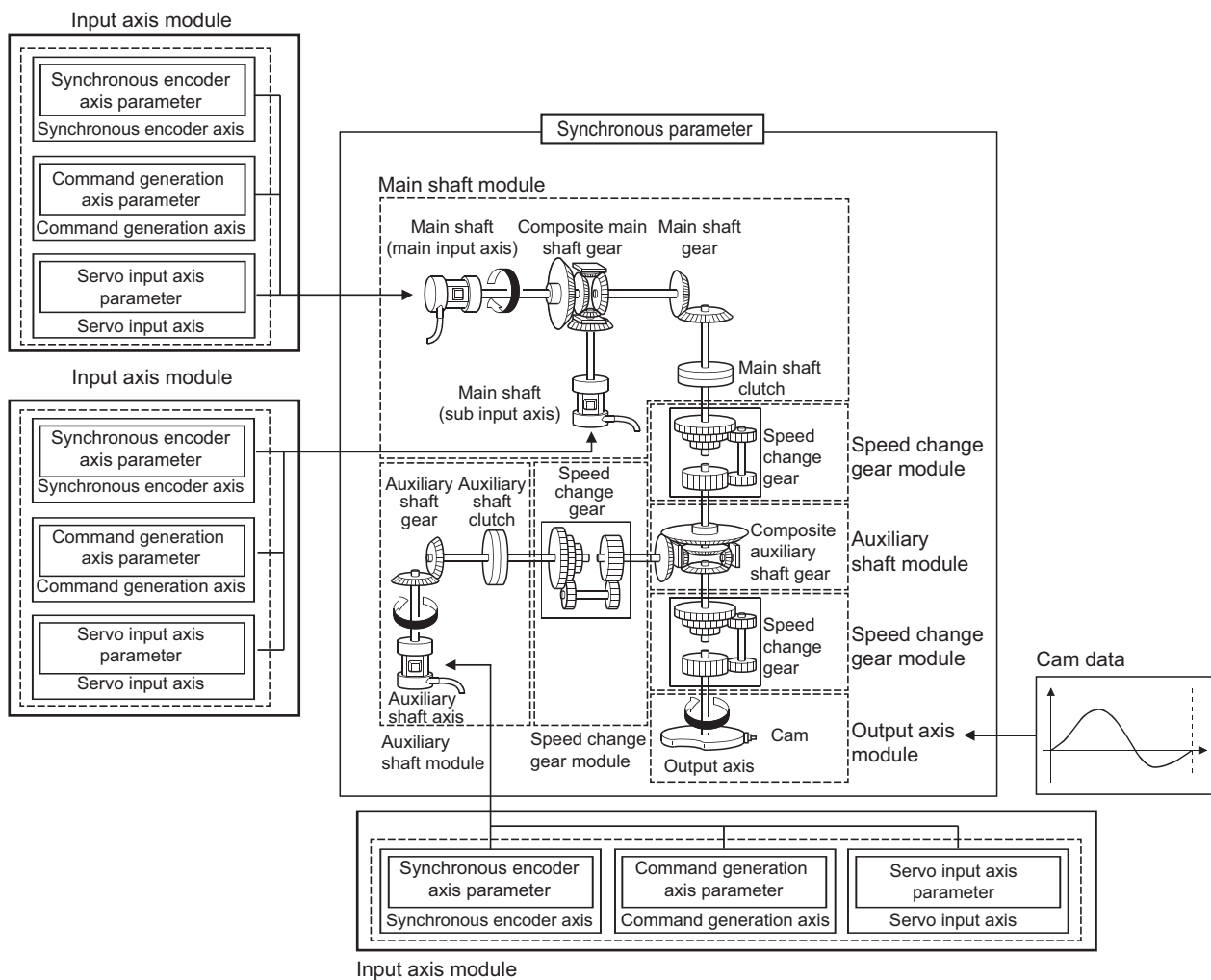

### Point

- Input axis module can be set to one of servo input axis, command generation axis or synchronous encoder axis.
- Speed change gear can be arranged on one of main shaft side, auxiliary shaft side or after composite auxiliary shaft gear.
- Set the movement amount of input axis module as large as possible to prevent the speed fluctuation of output axis module in the synchronous control. If the movement amount of input axis module is small, the speed fluctuation of output axis module may occur depending on the setting for advanced synchronous parameter.
- The following items can be monitored in the "Synchronous Control Image" window using the Simple Motion Module Setting Function/Motion Module Setting Function; each synchronous control monitor data and the rotation direction of main shaft main input axis, main shaft sub input axis, auxiliary shaft axis, and output axis (cam axis feed current value)





## Input axis

### • Input axis module



Name	Parts	Function description	Maximum number of usable			Reference
			Number per module		Number per axis	
			4-axis module	8-axis module		
Servo input axis	—	<ul style="list-style-type: none"> <li>Used to drive the input axis with the position of the servomotor controlled by the Simple Motion module/Motion module.</li> </ul>	4	8	—	Page 27 Servo Input Axis
Command generation axis	—	<ul style="list-style-type: none"> <li>Used to drive the input axis by generating only the positioning command based on the positioning data of the command generation axis.</li> </ul>	4	8	—	Page 34 Command Generation Axis
Synchronous encoder axis	—	<ul style="list-style-type: none"> <li>Used to drive the input axis with input pulse from the synchronous encoder.</li> </ul>	4		—	Page 55 Synchronous Encoder Axis

## Output axis

### • Main shaft module

Name	Parts	Function description	Maximum number of usable			Reference
			Number per module		Number per axis	
			4-axis module	8-axis module		
Main shaft main input axis		<ul style="list-style-type: none"> <li>The input axis on the main side of the main shaft module.</li> <li>The reference position on the main shaft.</li> </ul>	4	8	1	Page 96 Main Shaft Module
Main shaft sub input axis		<ul style="list-style-type: none"> <li>The input axis on the sub side of the main shaft module.</li> <li>It is used to input the compensation amount for the position of the main shaft main input axis.</li> </ul>	4	8	1	Page 96 Main Shaft Module
Composite main shaft gear		<ul style="list-style-type: none"> <li>The composite movement amount of the main shaft main input axis and the main shaft sub input axis are transmitted to the main shaft gear.</li> </ul>	4	8	1	Page 96 Main Shaft Module
Main shaft gear		<ul style="list-style-type: none"> <li>The converting movement amount after composite main shaft gear is transmitted by the setting gear ratio.</li> </ul>	4	8	1	Page 96 Main Shaft Module
Main shaft clutch		<ul style="list-style-type: none"> <li>The movement amount of the main shaft is transmitted by the clutch ON/OFF.</li> </ul>	4	8	1	Page 96 Main Shaft Module Page 113 Clutch

### • Auxiliary shaft module

Name	Parts	Function description	Maximum number of usable			Reference
			Number per module		Number per axis	
			4-axis module	8-axis module		
Auxiliary shaft axis		<ul style="list-style-type: none"> <li>The input axis of the auxiliary shaft module.</li> </ul>	4	8	1	Page 105 Auxiliary Shaft Module
Auxiliary shaft gear		<ul style="list-style-type: none"> <li>The converting movement amount of the auxiliary shaft is transmitted by the setting gear ratio.</li> </ul>	4	8	1	Page 105 Auxiliary Shaft Module
Auxiliary shaft clutch		<ul style="list-style-type: none"> <li>The movement amount of the auxiliary shaft is transmitted by the clutch ON/OFF.</li> </ul>	4	8	1	Page 105 Auxiliary Shaft Module Page 113 Clutch

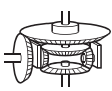
Name	Parts	Function description	Maximum number of usable			Reference
			Number per module		Number per axis	
			4-axis module	8-axis module		
Composite auxiliary shaft gear		<ul style="list-style-type: none"> <li>The composite movement amount of the main shaft and the auxiliary shaft are transmitted.</li> </ul>	4	8	1	Page 105 Auxiliary Shaft Module

• Speed change gear module

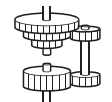
Name	Parts	Function description	Maximum number of usable			Reference
			Number per module		Number per axis	
			4-axis module	8-axis module		
Speed change gear		<ul style="list-style-type: none"> <li>It is used to change the speed by setting speed change ratio during the operation.</li> </ul>	4	8	1	Page 124 Speed Change Gear Module

• Output axis module

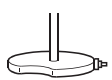
Name	Parts	Function description	Maximum number of usable			Reference
			Number per module		Number per axis	
			4-axis module	8-axis module		
Output axis		<ul style="list-style-type: none"> <li>The cam conversion is processed based on the input movement amount and the setting cam data, so that the feed current value is output as the command to the servo amplifier.</li> </ul>	4	8	1	Page 126 Output Axis Module

■Cam data

Name	Function description	Maximum number of usable	Reference
		Number per module	
Cam data	<ul style="list-style-type: none"> <li>It controls the operation pattern of the output axis (two-way operation and feed operation), which is corresponding to the input movement amount of the output axis module.</li> </ul>	Up to 256	Page 80 CAM FUNCTION

# 1.2 Performance Specifications

## Performance specifications

Item		Number of settable axes	
		4-axis module	8-axis module
Input axis	Servo input axis	4 axes/module	8 axes/module
	Command generation axis	4 axes/module	8 axes/module
	Synchronous encoder axis	4 axes/module	
Composite main shaft gear		1/output axis	
Main shaft main input axis		1 axis/output axis	
Main shaft sub input axis		1 axis/output axis	
Main shaft gear		1/output axis	
Main shaft clutch* <sup>1</sup>		1/output axis	
Auxiliary shaft		1 axis/output axis	
Auxiliary shaft gear		1/output axis	
Auxiliary shaft clutch* <sup>1</sup>		1/output axis	
Composite auxiliary shaft gear		1/output axis	
Speed change gear		1/output axis	
Output axis (Cam axis)		4 axes/module	8 axes/module

\*1 The accuracy of the start and clutch ON/OFF for the synchronous encoder in the high speed input request becomes the accuracy of operation cycle [FX5-SSC-G].

## Cam specifications

Item		Specification	
Memory capacity	Cam storage area	[FX5-SSC-S] 4-axis module: 64k bytes 8-axis module: 128k bytes	[FX5-SSC-G] 4-axis/8-axis module: 128k bytes
	Cam open area	1024k bytes	
Number of cam registration* <sup>1</sup>	Cam storage area	4-axis module: Up to 64 8-axis module: Up to 128 (Dependent on memory capacity, cam resolution and coordinate number)	
	Cam open area	Up to 256 (Dependent on memory capacity, cam resolution and coordinate number)	
Comment		Up to 32 characters per cam data	
Cam data	Stroke ratio data format	Cam resolution	256/512/1024/2048/4096/8192/16384
		Stroke ratio	-214.7483648 to 214.7483647 [%]
	Coordinate data format	Coordinate number	2 to 8192
		Coordinate data	Input value: 0 to 2147483647 Output value: -2147483648 to 2147483647

\*1 The maximum number of cam registration by the cam resolution is shown below. (In case it created by the same cam resolution.)

## ■Stroke ratio data format

### • FX5-SSC-S

Cam resolution	Maximum number of cam registration			
	Cam storage area		Cam open area	
	4-axis module	8-axis module	4-axis module	8-axis module
256	64	128	256	
512	32	64	256	
1024	16	32	256	
2048	8	16	128	
4096	4	8	64	
8192	2	4	32	
16384	1	2	16	

### • FX5-SSC-G

Cam resolution	Maximum number of cam registration			
	Cam storage area		Cam open area	
	4-axis module	8-axis module	4-axis module	8-axis module
256	128		256	
512	64		256	
1024	32		256	
2048	16		128	
4096	8		64	
8192	4		32	
16384	2		16	

## ■Coordinate data format

### • FX5-SSC-S

Coordinate number	Maximum number of cam registration			
	Cam storage area		Cam open area	
	4-axis module	8-axis module	4-axis module	8-axis module
128	64	128	256	
256	32	64	256	
512	16	32	256	
1024	8	16	128	
2048	4	8	64	
4096	2	4	32	
8192	1	2	16	

### • FX5-SSC-G

Cam resolution	Maximum number of cam registration			
	Cam storage area		Cam open area	
	4-axis module	8-axis module	4-axis module	8-axis module
128	128		256	
256	64		256	
512	32		256	
1024	16		128	
2048	8		64	
4096	4		32	
8192	2		16	

## Cam operation specifications

Item	Specification
Operation method of cam data	(1) Engineering tool Write/read/verify to cam storage area (2) Via buffer memory (Cam data operation function) Write/read to cam storage area and cam open area
Cam auto-generation function	Automatically generate the cam for rotary cutter.
Cam position calculation function	Calculate the cam position by the program. Used to calculate the cam position for the synchronous control initial position before starting synchronous control.

## Synchronous encoder axis specifications

Item	Specification	
Number of control axes	4	
Synchronous encoder axis type	Incremental synchronous encoder [FX5-SSC-S]/ Synchronous encoder via servo amplifier/ Synchronous encoder via CPU	
Control unit	mm, inch, degree, pulse (Possible to select the decimal places of position unit and speed unit)	
Unit conversion	Numerator	-2147483648 to 2147483647 [Synchronous encoder axis position unit]
	Denominator	1 to 2147483647 [pulse]
Length per cycle setting range	1 to 2147483647 [Synchronous encoder axis position unit]	
Current value range	Current value	-2147483648 to 2147483647 [Synchronous encoder axis position unit]
	Current value per cycle	0 to (Length per cycle - 1) [Synchronous encoder axis position unit]
Control method	Control instruction	Current value change, Counter disable, Counter enable
	Current value setting address	Address setting range: -2147483648 to 2147483647 [Synchronous encoder axis position unit]

# 1.3 Operation Method of Synchronous Control

## Synchronous control execution procedure

The synchronous control is executed using the following procedure.

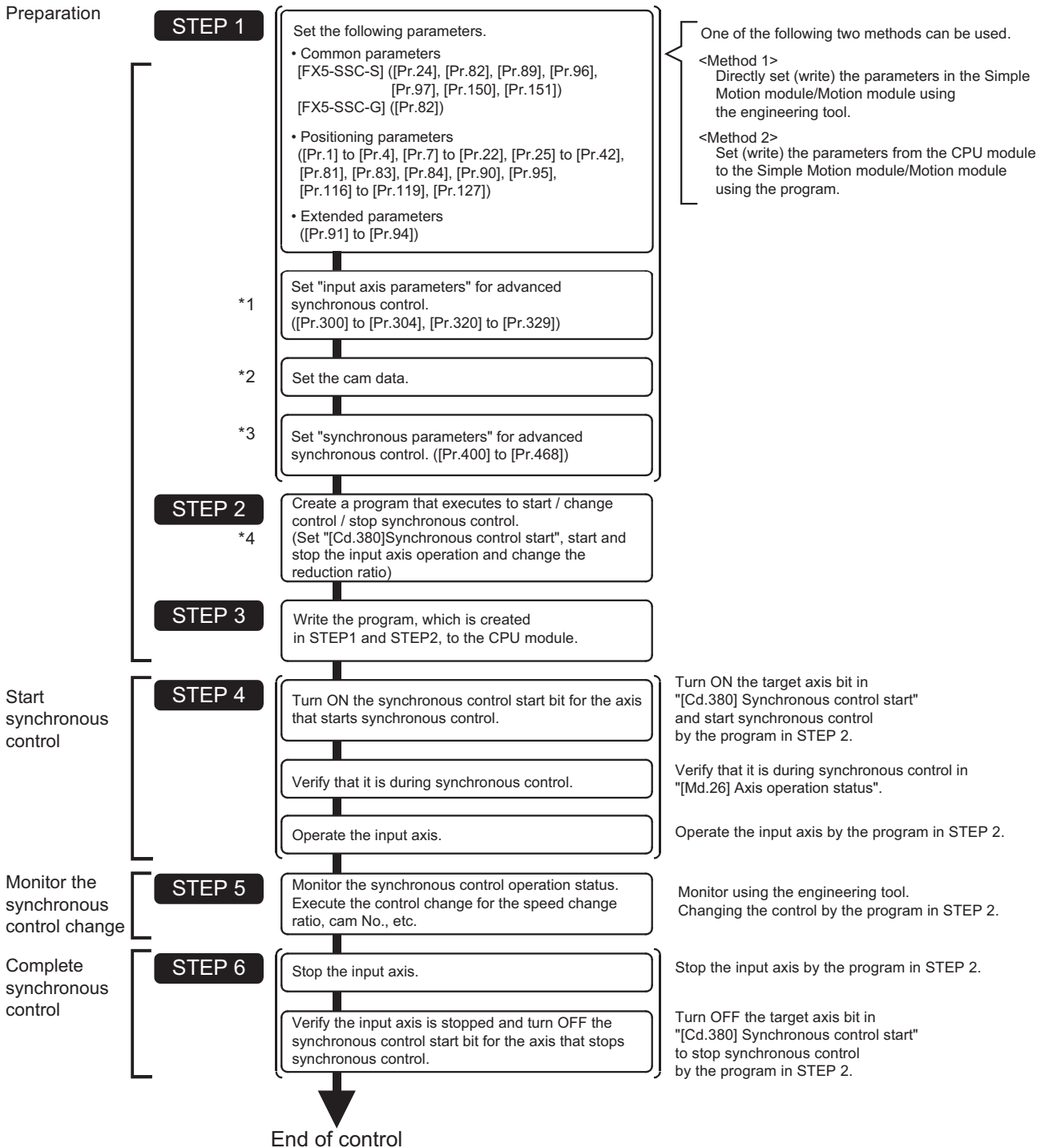

\*1 Page 27 INPUT AXIS MODULE

\*2 Page 80 CAM FUNCTION

\*3 Page 96 ADVANCED SYNCHRONOUS CONTROL, Page 146 Synchronous Control Initial Position Parameters

\*4 Page 177 Sample Program of Synchronous Control



## Precautions

- Mechanical elements such as limit switches are considered as already installed.
- Parameter settings for positioning control apply for all axes with the Simple Motion module/Motion module.
- Be sure to execute the home position return when the home position return request flag is ON.

## Starting/ending for synchronous control

Set the advanced synchronous control parameters for each output axis to start synchronous control.

The status changes to synchronous control after the advanced synchronous control parameters are analyzed at the start of synchronous control, and the output axes synchronize with input axis operations.

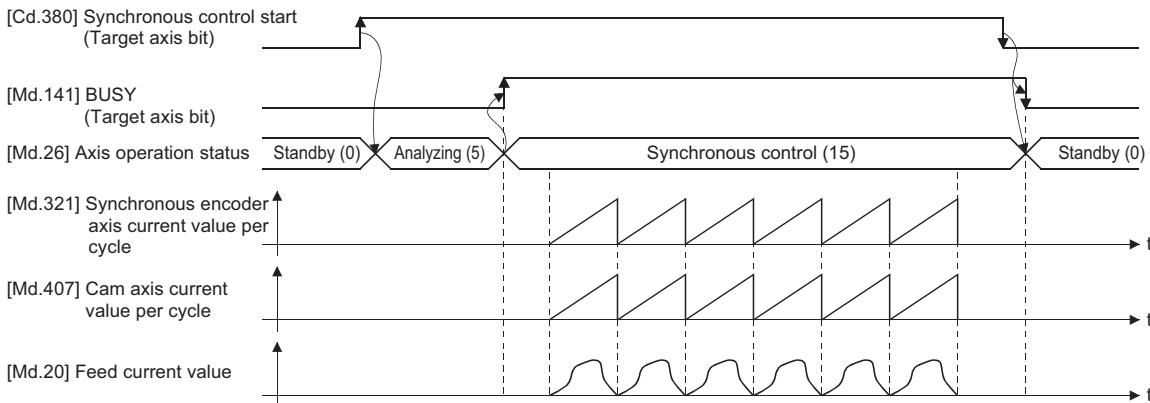

## Synchronous control system control data

Setting item	Setting details	Setting value	Default value	Buffer memory address
[Cd.380] Synchronous control start	<ul style="list-style-type: none"> <li>• Synchronous control begins if the target axis bit is turned ON.</li> <li>• Synchronous control ends if the bit is turned OFF during synchronous control.</li> </ul> Fetch cycle: Operation cycle	■Set the target axis in 16 bits. (bit0: axis 1 to bit7: axis 8) <sup>*1</sup> OFF: Synchronous control end ON: Synchronous control start	0	36320

\*1 The range from axis 1 to 4 is valid in the 4-axis module and from axis 1 to 8 is valid in the 8-axis module.

## Starting method for synchronous control

Synchronous control can be started by turning the target axis bit from OFF to ON in "[Cd.380] Synchronous control start" after setting the advanced synchronous control parameters.

"5: Analyzing" is set in "[Md.26] Axis operation status" at the synchronous control start, and the advanced synchronous control parameters are analyzed. "[Md.141] BUSY" turns ON after completion of analysis, and "15: Synchronous control" is set in "[Md.26] Axis operation status".

Start the input axis operation after confirming that "15: Synchronous control" is set in "[Md.26] Axis operation status".

## Ending method for synchronous control

Synchronous control can be ended by turning the target axis bit from ON to OFF in "[Cd.380] Synchronous control start" after the input axis operation is stopped.

"[Md.141] BUSY" turns OFF at the synchronous control end, and "0: Standby" is set in "[Md.26] Axis operation status" at the output axis stop.

Synchronous control can also be ended by turning the target axis bit from ON to OFF in "[Cd.380] Synchronous control start" during the input axis operation. However, it is recommended to end after stopping the input axis operation since the output axis stops immediately.

Refer to the following for the stop operation of output axis at the synchronous control end.

☞ Page 25 Stop operation of output axis

## Starting history

The starting history is updated when starting synchronous control. "9020: Synchronous control operation" is stored in "[Md.4] Start No."

## Status when starting synchronous control

The following bits in "[Md.31] Status" are turned OFF when starting synchronous control in the same way as for the positioning control start.

Bit	Details
b0	In speed control flag
b1	Speed-position switching latch flag
b2	Command in-position flag
b4	Home position return complete flag
b5	Position-speed switching latch flag
b10	Speed change 0 flag

### Restriction

- If bit for multiple axes are turned ON simultaneously in "[Cd.380] Synchronous control start", control is not started simultaneously since the analysis is processed for each axis in numerical order. When the multiple axes must be started simultaneously, start the input axis operation after confirming that all axes are configured for the synchronous control.
- If the input axis operates during the analysis at the synchronous control start, the movement amount of the input axis is reflected immediately after the synchronous control start. The output axis might rapidly accelerate depending on the movement amount of the input axis. Start the input axis operation after confirming that are configured for synchronous control.
- The analysis process for synchronous control start might take time depending on the setting of the advanced synchronous control parameter. (When "0: Cam axis current value per cycle restoration" is set in "[Pr.462] Cam axis position restoration object" and the cam (cam resolution: 16384) is searched: About 40 ms, When "0: Cam axis current value per cycle restoration" is set in "[Pr.462] Cam axis position restoration object" and the cam (cam resolution: 256) is searched: About 1.0 ms) Set "1: Cam reference position restoration" or "2: Cam axis feed current value restoration" in "[Pr.462] Cam axis position restoration object" to start synchronous control at high speed.
- When the advanced synchronous control parameter is set to the value outside the setting range, the synchronous control does not start, and the input axis error No. is stored in the monitor data.

## Stop operation of output axis

If the following causes occur in stopping the output axis during synchronous control, synchronous control is completed after stops processing for the output axis ("[Md.141] BUSY" is OFF, "[Md.26] Axis operation status" is standby).

Synchronous alignment must be executed for the output axis to restart the synchronous control. (Page 126 Output Axis Module)

Stop cause	Stop process
The target axis bit of "[Cd.380] Synchronous control start" is turned from ON to OFF.	Immediate stop
Software stroke limit error occurrence	
Emergency stop	
Forced stop	
Stop group1 to 3*1 (Stop with hardware stroke limit or stop command)	Deceleration stop

\*1 Refer to "Stop" in the following manual.

 MELSEC iQ-F FX5 Motion Module/Simple Motion Module User's Manual (Application)

### Immediate stop

The operation stops without decelerate. The Simple Motion module/Motion module immediately stops the command, but the operation will coast for the droop pulses accumulated in the deviation counter of the servo amplifier.

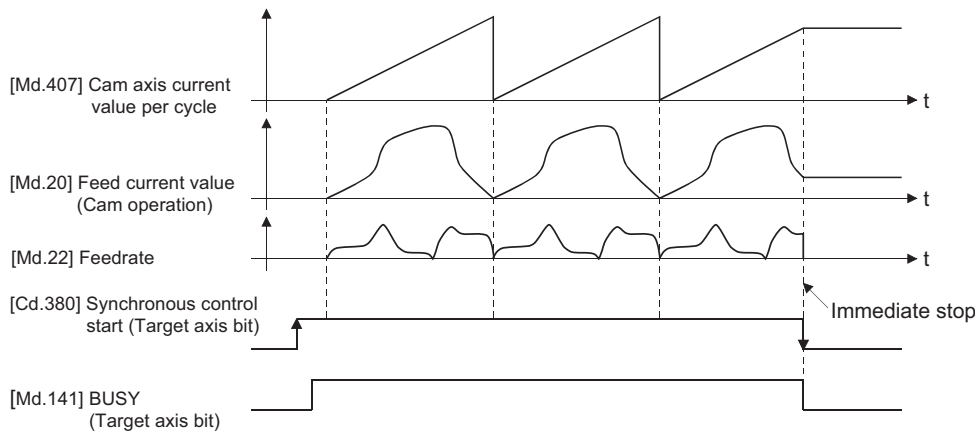

## Deceleration stop

The output axis stops with deceleration according to the setting in "[Pr.37] Stop group 1 rapid stop selection" to "[Pr.39] Stop group 3 rapid stop selection". The deceleration time set in "[Pr.446] Synchronous control deceleration time" is used for deceleration stop, and the shorter time set for the rapid stop time between "[Pr.36] Rapid stop deceleration time" and "[Pr.446] Synchronous control deceleration time" is used for rapid stop. The slope of deceleration is as follows.

$$\text{Slope of deceleration} = \frac{[\text{Pr.8}] \text{ Speed limit value}}{\text{Deceleration time (Rapid stop deceleration time)}}$$

The cam axis current value per cycle is not updated, and only the feed current value is updated, since the deceleration stop begins. Therefore, the path of the feed current value is drawn regardless the cam operation with deceleration stop.

The input axis must be stopped when the output axis is stop synchronizing with the input axis.

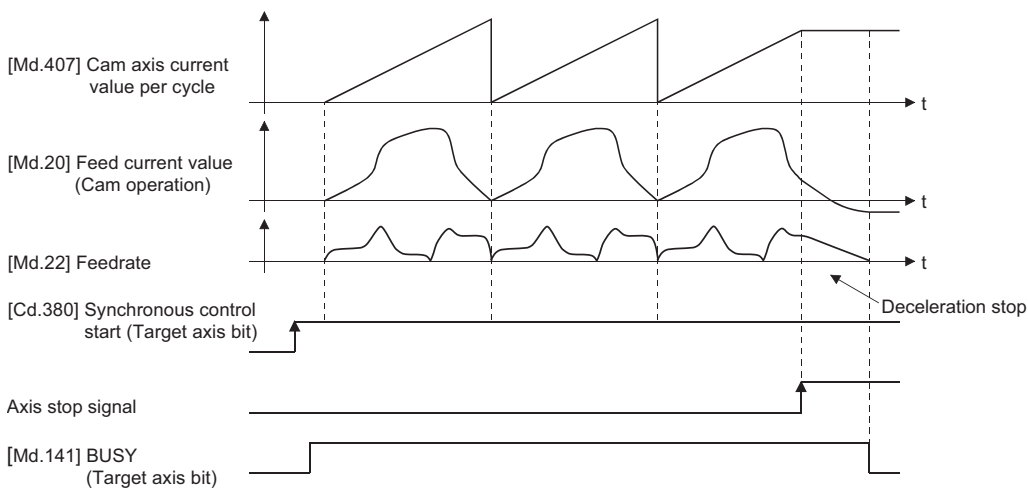

# 2 INPUT AXIS MODULE

The settings for the parameter and monitor data for the input axis module that used with synchronous control are explained in this chapter.

Refer to the following manual for details on the connection and control for the servo amplifier and the synchronous encoder that are used for input axis module.

📖 MELSEC iQ-F FX5 Motion Module/Simple Motion Module User's Manual (Application)

## 2.1 Servo Input Axis

### Overview of servo input axis

The servo input axis is used to drive the input axis based on the position of the servomotor that is being controlled by the Simple Motion module/Motion module.

The status of a servo input axis can also be monitored even before the synchronous control start since the setting of a servo input axis is valid after the system's power supply ON.

The status of a servo input axis can be monitored after the system's power supply ON.

The following shows the relationship between the position of the servomotor and the servo input axis.

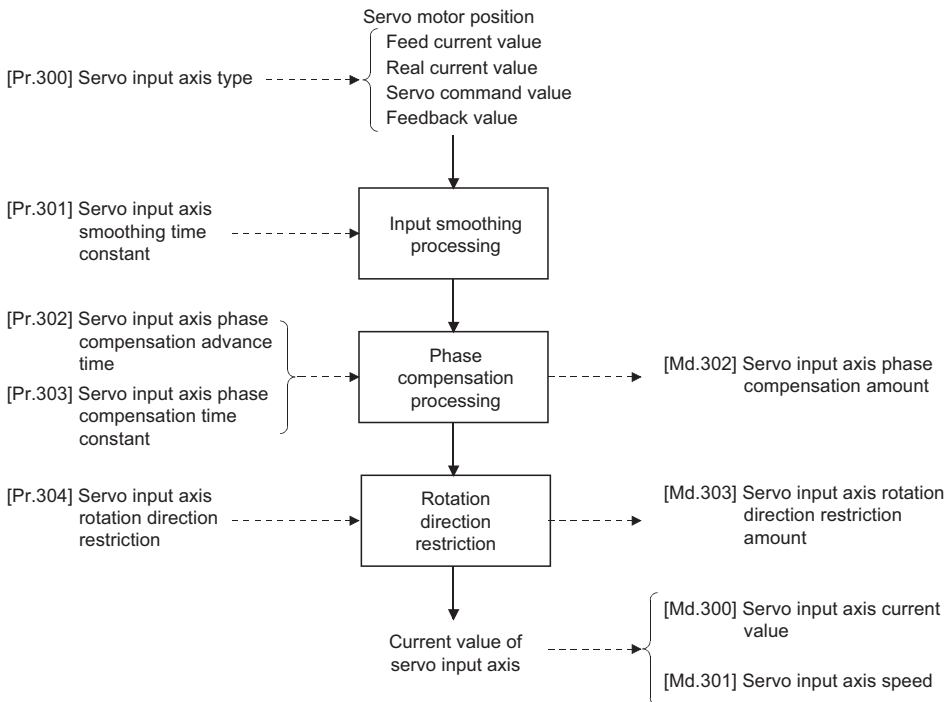

### Control method for servo input axis

All controls (including synchronous control) can be executed for a servo input axis.

Refer to the following manual for the controls other than the synchronous control.

📖 MELSEC iQ-F FX5 Motion Module/Simple Motion Module User's Manual (Application)

#### Point

If the virtual servo amplifier function is set in the servo input axis, synchronous control can be executed by the input value as virtual.

Refer to "Virtual Servo Amplifier Function" in the following manual for details on virtual servo amplifier function.

📖 MELSEC iQ-F FX5 Motion Module/Simple Motion Module User's Manual (Application)

**Restriction**

If "1: Feed current value" or "2: Real current value" is set in "[Pr.300] Servo input axis type", set "1: Update feed current value" in "[Pr.21] Feed current value during speed control" to start the speed position change control. If "0: Do not update feed current value" or "2: Clear feed current value to zero" is set in "[Pr.21] Feed current value during speed control", the error "Speed-position switching control start in servo input axis not possible" (error code: 1BA7H [FX5-SSC-S], or error code: 1DF7H [FX5-SSC-G]) will occur and the control will not start.

## Units for the servo input axis

The position units and speed units for the servo input axis are shown below for the setting "[Pr.300] Servo input axis type" and "[Pr.1] Unit setting".

### ■ Servo input axis position units

Setting value of "[Pr.300] Servo input axis type"	Setting value of "[Pr.1] Unit setting"	Servo input axis position unit	Range
1: Feed current value 2: Real current value	0: mm	$\times 10^{-4}$ mm ( $10^{-1}$ $\mu$ m)	-214748.3648 to 214748.3647 [mm] (-214748364.8 to 214748364.7 [ $\mu$ m])
	1: inch	$\times 10^{-5}$ inch	-21474.83648 to 21474.83647 [inch]
	2: degree	$\times 10^{-5}$ degree	-21474.83648 to 21474.83647 [degree]
	3: pulse	pulse	-2147483648 to 2147483647 [pulse]
3: Servo command value 4: Feedback value	—	pulse	-2147483648 to 2147483647 [pulse]

### ■ Servo input axis speed units

Setting value of "[Pr.300] Servo input axis type"	Setting value of "[Pr.1] Unit setting"	Servo input axis speed unit	Range
1: Feed current value 2: Real current value	0: mm	$\times 10^{-2}$ mm/min	-21474836.48 to 21474836.47 [mm/min]
	1: inch	$\times 10^{-3}$ inch/min	-2147483.648 to 2147483.647 [inch/min]
	2: degree	$\times 10^{-3}$ degree/min <sup>*1</sup>	-2147483.648 to 2147483.647 [degree/min] <sup>*1</sup>
	3: pulse	pulse/s	-2147483648 to 2147483647 [pulse/s]
3: Servo command value 4: Feedback value	—	pulse/s	-2147483648 to 2147483647 [pulse/s]

\*1 This will be the speed unit " $\times 10^{-2}$  degree/min" (Range: -21474836.48 to 21474836.47 [degree/min]), when "[Pr.83] Speed control 10  $\times$  multiplier setting for degree axis" is valid.

**Point**

When "1: Feed current value" or "3: Servo command value" is set in "[Pr.300] Servo input axis type", and the servo input axis becomes servo OFF by the servo alarm or forced stop, the amount of value change may be large. This can be prevented by setting "2: Real current value" or "4: Feedback value" in "[Pr.300] Servo input axis type".

# Servo input axis parameters

n: Axis No. - 1

Setting item	Setting details	Setting value	Default value	Buffer memory address
[Pr.300] Servo input axis type	<ul style="list-style-type: none"> <li>Set the current value type to be generated of the input value for the servo input axis.</li> </ul> <u>Fetch cycle: At power supply ON</u>	<ul style="list-style-type: none"> <li>Set in decimal.</li> <li>0: Invalid</li> <li>1: Feed current value</li> <li>2: Real current value</li> <li>3: Servo command value</li> <li>4: Feedback value</li> </ul>	0	32800+10n
[Pr.301] Servo input axis smoothing time constant	<ul style="list-style-type: none"> <li>Set to smooth the input value.</li> </ul> <u>Fetch cycle: At power supply ON</u>	<ul style="list-style-type: none"> <li>Set in decimal.</li> <li>0 to 5000 [ms]</li> </ul>	0	32801+10n
[Pr.302] Servo input axis phase compensation advance time	<ul style="list-style-type: none"> <li>Set the time to advance or delay the phase.</li> </ul> <u>Fetch cycle: Operation cycle</u>	<ul style="list-style-type: none"> <li>Set in decimal.</li> <li>-2147483648 to 2147483647 [<math>\mu</math>s]</li> </ul>	0	32802+10n 32803+10n
[Pr.303] Servo input axis phase compensation time constant	<ul style="list-style-type: none"> <li>Set the time constant to affect the phase compensation.</li> </ul> <u>Fetch cycle: At power supply ON</u>	<ul style="list-style-type: none"> <li>Set in decimal.</li> <li>0 to 65535 [ms]<sup>*1</sup></li> </ul>	10	32804+10n
[Pr.304] Servo input axis rotation direction restriction	<ul style="list-style-type: none"> <li>Set this parameter to restrict the input movement amount to one direction.</li> </ul> <u>Fetch cycle: At power supply ON</u>	<ul style="list-style-type: none"> <li>Set in decimal.</li> <li>0: Without rotation direction restriction</li> <li>1: Enable only for current value increase direction</li> <li>2: Enable only for current value decrease direction</li> </ul>	0	32805+10n

\*1 Set the value as follows in a program.  
 0 to 32767: Set as a decimal.  
 32768 to 65535: Convert into a hexadecimal and set.

## [Pr.300] Servo input axis type

Set the current value type to be generated of the input value for the servo input axis.

Setting value	Details
0: Invalid	Servo input axis is invalid.
1: Feed current value	Generate the input value based on "[Md.20] Feed current value".
2: Real current value	Generate the input value based on the real current value, which is converted into units of the encoder feedback pulses from the servo amplifier.
3: Servo command value	Generate the input value based on the command pulse for the servo amplifier (a value that the feed current value is converted into encoder pulse units).
4: Feedback value	Generate the input value based on the encoder feedback pulse from the servo amplifier.

Simple Motion module/Motion module

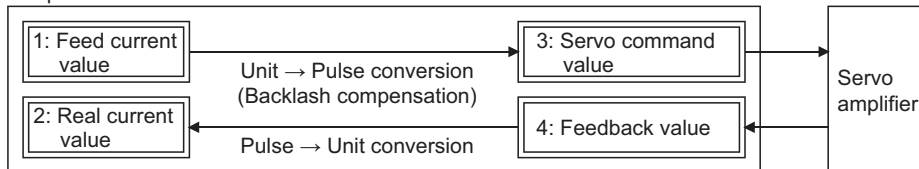

## [Pr.301] Servo input axis smoothing time constant

Set the averaging time to execute a smoothing process for the input movement amount from the servo input axis. The smoothing process can moderate speed fluctuation, when the "Real current value" or "Feedback value" is used as input values. The input response is delayed depending on the time corresponding to the setting by smoothing process setting.

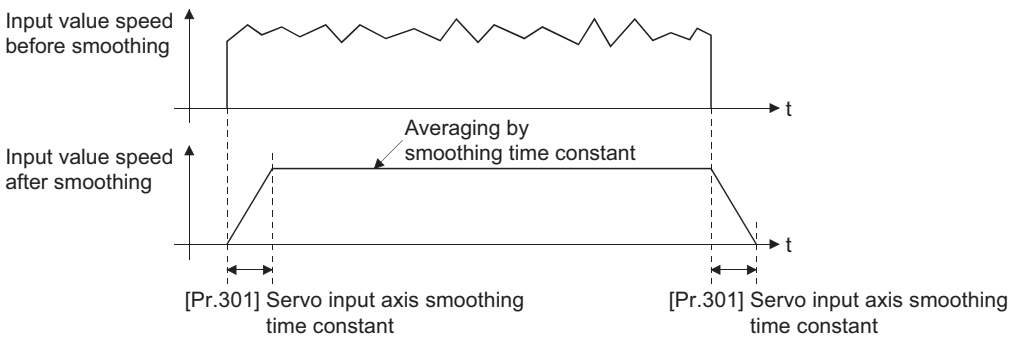

## [Pr.302] Servo input axis phase compensation advance time

Set the time to advance or delay the phase (input response) of the servo input axis. Refer to the following for the delay time inherent to the system using the servo input axis.

☞ Page 139 Phase Compensation Function

Setting value	Details
1 to 2147483647 [ $\mu$ s]	Advance the phase (input response) according to the setting time.
0 [ $\mu$ s]	Do not execute phase compensation.
-2147483648 to -1 [ $\mu$ s]	Delay the phase (input response) according to the setting time.

If the setting time is too long, the system experiences overshoot or undershoot at acceleration/deceleration of the input speed. In this case, set longer time to affect the phase compensation amount in "[Pr.303] Servo input axis phase compensation time constant".

## [Pr.303] Servo input axis phase compensation time constant

Set the time constant to affect the phase compensation amount for the first order delay. 63 [%] of the phase compensation amount are reflected in the time constant setting.

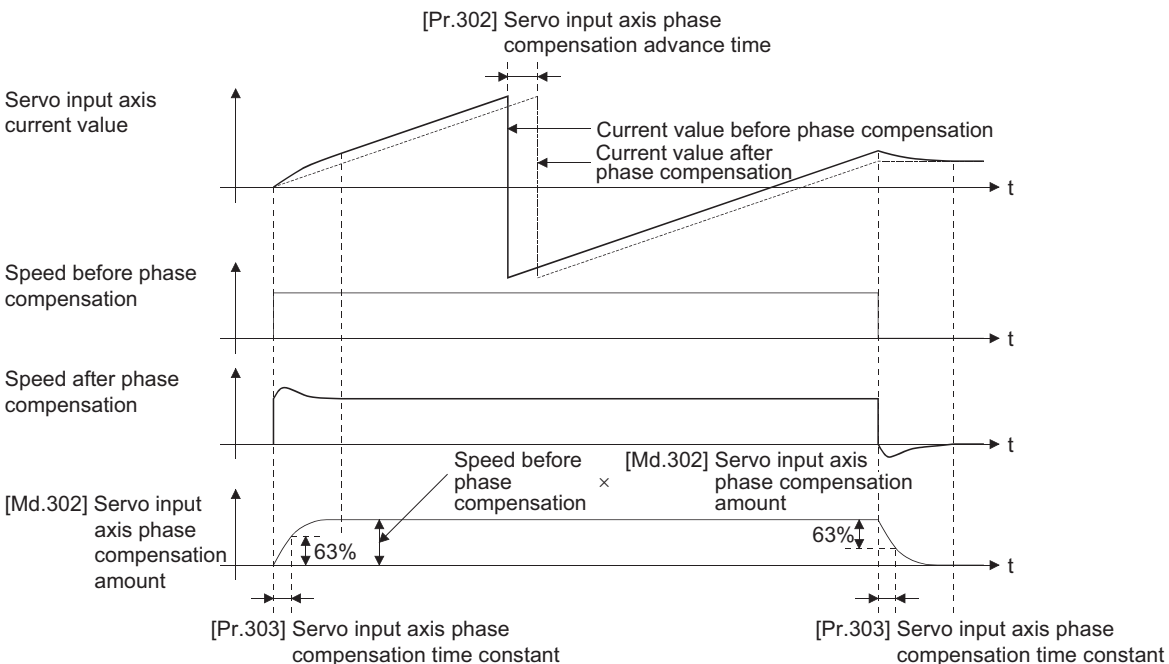



## [Pr.304] Servo input axis rotation direction restriction

Set this parameter to restrict the input movement amount for the servo input axis to one direction.

This helps to avoid reverse operation caused by machine vibration, etc. when "Real current value" or "Feedback value" is used as input values.

Setting value	Details
0: Without rotation direction restriction	Rotation direction restriction is not executed.
1: Enable only for current value increase direction	Enable only the input movement amount in the increasing direction of the servo input axis current value.
2: Enable only for current value decrease direction	Enable only the input movement amount in the decreasing direction of the servo input axis current value.

The input movement amount in the reverse direction of the enabled direction accumulates as a rotation direction restricted amount, and will be reflected when the input movement amount moves in the enabled direction again. Therefore, the current value of servo input does not deviate when the reverse operation is repeated.

The rotation direction restricted amount is set to 0 when the following operations are executed for the servo input axis.

- A servo amplifier is connected
- The home position return is executed
- The current value is changed

For "1: Enable only for current value increase direction" is set in "[Pr.304] Servo input axis rotation direction restriction".

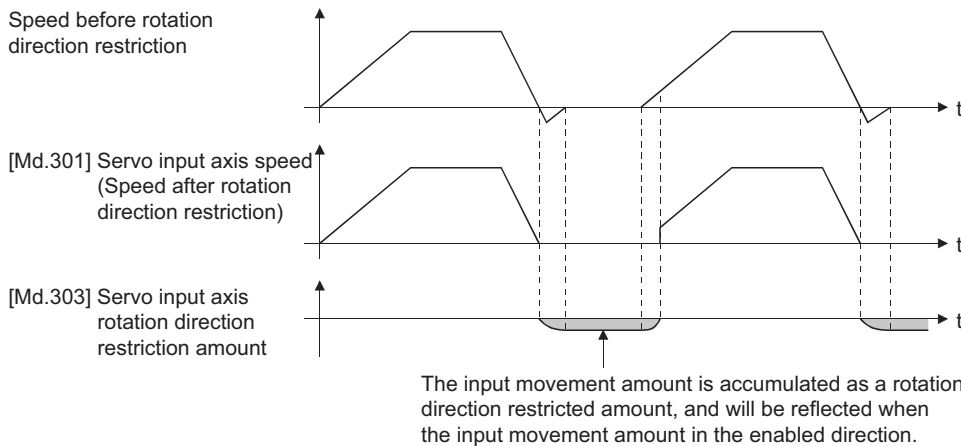

# Servo input axis monitor data

n: Axis No. - 1

Monitor item	Storage details	Monitor value	Buffer memory address
[Md.300] Servo input axis current value	<ul style="list-style-type: none"> <li>The current value for the servo input axis is stored.</li> </ul> Refresh cycle: Operation cycle	■Monitoring is carried out in decimal. -2147483648 to 2147483647 [Servo input axis position units <sup>*1</sup> ]	33120+10n 33121+10n
[Md.301] Servo input axis speed	<ul style="list-style-type: none"> <li>The speed for the servo input axis is stored.</li> </ul> Refresh cycle: Operation cycle	■Monitoring is carried out in decimal. -2147483648 to 2147483647 [Servo input axis speed units <sup>*2</sup> ]	33122+10n 33123+10n
[Md.302] Servo input axis phase compensation amount	<ul style="list-style-type: none"> <li>The current phase compensation amount is stored.</li> </ul> Refresh cycle: Operation cycle	■Monitoring is carried out in decimal. -2147483648 to 2147483647 [Servo input axis position units <sup>*1</sup> ]	33124+10n 33125+10n
[Md.303] Servo input axis rotation direction restriction amount	<ul style="list-style-type: none"> <li>While the rotation direction is restricted, the accumulation for the input movement amount in the opposite direction of the enabled direction is stored.</li> </ul> Refresh cycle: Operation cycle	■Monitoring is carried out in decimal. -2147483648 to 2147483647 [Servo input axis position units <sup>*1</sup> ]	33126+10n 33127+10n

\*1 Servo input axis position units (  Page 28 Servo input axis position units)

\*2 Servo input axis speed units (  Page 28 Servo input axis speed units)

## [Md.300] Servo input axis current value

The current value for the servo input axis is stored in servo input axis position units (  Page 28 Servo input axis position units) as follows.

The current value for the servo input axis is the value after processing the smoothing, the phase compensation and the rotation direction restriction.

Setting value of "[Pr.300] Servo input axis type"	Storage details
1: Feed current value 2: Real current value	<ul style="list-style-type: none"> <li>The accumulative current value started with "[Md.20] Feed current value"/"[Md.101] Real current value" for the connection to the servo amplifier is stored. It is also stored in the range from -21474.83648 to 21474.83647 [degree] for degree units.</li> <li>When the "[Md.20] Feed current value"/"[Md.101] Real current value" is changed by the home position return or the current value change, the value is changed to the new current value.</li> </ul>
3: Servo command value 4: Feedback value	<ul style="list-style-type: none"> <li>When of the absolute position detection system setting is invalid, the accumulative current value that starts from 0 for the connected servo amplifier is stored.</li> <li>When of the absolute position detection system setting is valid, the accumulative current value that starts from the absolute position command/encoder feedback pulse for the connected servo amplifier is stored.</li> <li>The servo input axis current value will not change, even if the home position return or the current value is changed.</li> </ul>

## [Md.301] Servo input axis speed

The speed for the servo input axis is stored in servo input axis speed units (  Page 28 Servo input axis speed units).

The speed for the servo input axis is the value after processing smoothing, phase compensation, and rotation direction restriction.

## [Md.302] Servo input axis phase compensation amount

The phase compensation amount for a servo input axis is stored in servo input axis position units (  Page 28 Servo input axis position units).

The phase compensation amount for a servo input axis is the value after processing smoothing and phase compensation.

## [Md.303] Servo input axis rotation direction restriction amount

While the rotation direction is restricted for a servo input axis, the accumulation for input movement amount in the opposite direction of the enabled direction is stored in servo input axis position units (  Page 28 Servo input axis position units) as follows.

Setting value of "[Pr.304] Servo input axis rotation direction restriction"	Storage details
1: Enable only for current value increase direction	A negative accumulation is stored during rotation direction restriction. 0 is stored if there is no restriction.
2: Enable only for current value decrease direction	A positive accumulation is stored during rotation direction restriction. 0 is stored if there is no restriction.

Rotation direction restriction is processed after phase compensation processing. Therefore, if undershoot occurs from phase compensation during deceleration stop, the rotation direction restriction amount might remain.

## 2.2 Command Generation Axis

### Overview of command generation axis

The command generation axis is an axis that executes command generation only. It can be controlled individually from the axis connected with a servo amplifier.

The command generation axis is used to drive the input axis based on the positioning data or the JOG operation. The axis set in "[Pr.100] Servo series" is defined as "servo amplifier axis" against "command generation axis".

#### Control method for the command generation axis

The command generation axis operates following to the positioning data and control data of the command generation axis. The controls that can be used for the command generation axis are shown below.

○: Available, ×: Not available

Control mode	Control	Availability
Linear control	ABS linear 1, INC linear 1	○
	ABS linear 2, INC linear 2 ABS linear 3, INC linear 3 ABS linear 4, INC linear 4	×
Circular interpolation control	ABS circular sub, ABS circular right, ABS circular left INC circular sub, INC circular right, INC circular left	×
Fixed-feed	Fixed-feed 1, Fixed-feed 2, Fixed-feed 3, Fixed-feed 4	×
Speed control	Forward run speed 1, Reverse run speed 1	○
	Forward run speed 2, Reverse run speed 2 Forward run speed 3, Reverse run speed 3 Forward run speed 4, Reverse run speed 4	×
Speed-position control	Forward run speed/position, Reverse run speed/position	○
Position-speed control	Forward run position/speed, Reverse run position/speed	×
Current value change		○
Simultaneous start		×
JOG operation		○
Manual pulse generator operation		×
Home position return		×

The control details are common with "major positioning controls". For details, refer to "MAJOR POSITIONING CONTROL" in the following manual.

📖 MELSEC iQ-F FX5 Motion Module/Simple Motion Module User's Manual (Application)

The sub functions that can be used for the command generation axis are shown below.

○: Combination possible

△: Combination restricted

×: Combination not possible

Sub function	Control mode							
	ABS linear 1	INC linear 1	Forward run speed 1	Reverse run speed 1	Forward run speed/ position	Reverse run speed/ position	Current value change	JOG operation
Home position return retry function	×	×	×	×	×	×	×	×
Home position shift function	×	×	×	×	×	×	×	×
Backlash compensation function	×	×	×	×	×	×	×	×
Electronic gear function	×	×	×	×	×	×	×	×
Near pass function	△ <sup>*1</sup>	△ <sup>*1</sup>	△ <sup>*1</sup>	△ <sup>*1</sup>	△ <sup>*1</sup>	△ <sup>*1</sup>	△ <sup>*1</sup>	×
Speed limit function	○	○	○	○	○	○	×	○
Torque limit function	×	×	×	×	×	×	×	×
Software stroke limit function	○	○	○	○	○	○	○	○
Hardware stroke limit function	×	×	×	×	×	×	×	×
Forced stop function	○	○	○	○	○	○	○	○
Speed change function	○	○	○	○	○	○	×	○
Override function	○	○	○	○	○	○	×	○
Acceleration/deceleration time change function	○	○	○	○	○	○	×	○
Torque change function	×	×	×	×	×	×	×	×
Target position change function	△ <sup>*2</sup>	△ <sup>*2</sup>	×	×	×	×	×	×
Pre-reading start function	×	×	×	×	×	×	×	×
Stop command processing for deceleration stop function	○	○	○	○	○	○	×	×
Step function	×	×	×	×	×	×	×	×
Skip function	×	×	×	×	×	×	×	×
M code output function	×	×	×	×	×	×	△ <sup>*3</sup>	×
Teaching function	×	×	×	×	×	×	×	×
Command in-position function	○	○	○	○	○	○	×	×
Acceleration/deceleration processing function	○	○	○	○	○	○	×	○
Deceleration start flag function	○	○	×	×	△ <sup>*4</sup>	△ <sup>*4</sup>	×	×
Speed control 10 times multiplier setting for degree axis function	○	○	○	○	○	○	×	○
Operation setting for incompleteness of home position return function	×	×	×	×	×	×	×	×

\*1 The near pass function is validated only when the machine of the standard specification carries out the position control with the continuous path control mode.

\*2 Invalid during the continuous path control mode.

\*3 Execute the current value change using the positioning data. It is not output using the positioning start No.9003.

\*4 Valid only when the deceleration start during positioning control.

The following shows the support status of sub functions excluding above.

○: Combination possible, ×: Combination not possible

Function		Combination status
Sub function	Absolute position system	×
	Continuous operation interrupt function	○
	Follow up function	×

### ■Change command generation axis parameters and positioning data

The command generation axis does not store parameters or positioning data in the buffer memory. Therefore, rewrite the parameters and the positioning data using the following methods.

- When using GX Works3

Set the command generation axis parameters and positioning data using GX Works3. After that, execute writing to the Simple Motion module or writing to the Motion Module.

- When using command generation axis control data

[Change command generation axis parameters]

Use the following control data. For details, refer to  Page 52 Write/read method for command generation axis parameter and positioning data.

- [Cd.300] Command generation axis parameter No. designation
- [Cd.301] Command generation axis parameter setting value
- [Cd.302] Command generation axis parameter control request

[Change command generation axis positioning data]

Use the following control data. For details, refer to  Page 52 Write/read method for command generation axis parameter and positioning data.

- [Cd.303] Command generation axis positioning data No. designation
- [Cd.304] Command generation axis positioning data designation
- [Cd.305] Command generation axis positioning data setting value
- [Cd.306] Command generation axis positioning data control request

### ■Setting for command generation axis

Set "1: Valid" in "[Pr.340] Command generation axis valid setting" using the methods above. The command generation axis setting is fetched at the power ON. Therefore, to disconnect the command generation axis, turn ON the Simple Motion module/Motion module power supply again after setting "0: Invalid" in "[Pr.340] Command generation axis valid setting".

### ■Start request

Specify the positioning data No. in "[Cd.3] Positioning start No." and set "1: ON" in "[Cd.184] Positioning start". The start complete signal ([Md.31] Status: b14) and "[Md.141] BUSY" turn ON, and the positioning operation starts.

### ■Troubleshooting

Output the axis error and warning which are same as the servo amplifier axis to "[Md.23] Axis error No." and "[Md.24] Axis warning No." of the command generation axis.

## Units for the command generation axis

The position units and speed units for the command generation axis are shown below based on the setting "[Pr.1] Unit setting".

### ■Command generation axis position units

Setting value of "[Pr.1] Unit setting"	Command generation axis position unit	Range
0: mm	$\times 10^{-1}$ $\mu\text{m}$	-214748364.8 to 214748364.7 [ $\mu\text{m}$ ]
1: inch	$\times 10^{-5}$ inch	-21474.83648 to 21474.83647 [inch]
2: degree	$\times 10^{-5}$ degree	0.00000 to 359.99999 [degree]
3: pulse	pulse	-2147483648 to 2147483647 [pulse]

### ■Command generation axis speed units

Setting value of "[Pr.1] Unit setting"	Command generation axis speed unit	Range
0: mm	$\times 10^{-2}$ mm/min	-21474836.48 to 21474836.47 [mm/min]
1: inch	$\times 10^{-3}$ inch/min	-2147483.648 to 2147483.647 [inch/min]
2: degree	$\times 10^{-3}$ degree/min <sup>*1</sup>	-2147483.648 to 2147483.647 [degree/min] <sup>*1</sup>
3: pulse	pulse/s	-2147483648 to 2147483647 [pulse/s]

\*1 This will be the speed unit " $\times 10^{-2}$  degree/min" (Range: -21474836.48 to 21474836.47 [degree/min]), when "[Pr.83] Speed control 10  $\times$  multiplier setting for degree axis" is valid.

## Operation at forced stop

When the command generation axis starts while "[Pr.82] Forced stop valid/invalid selection" is set to valid, the error "Start not possible" (error code: 1928H [FX5-SSC-S], or error code: 1A28H [FX5-SSC-G]) occurs and the command generation axis does not start. When the forced stop input signal turns OFF during operation, the axis stops rapidly according to the setting of "[Pr.36] Rapid stop deceleration time" and "1: Stopped" is set in "[Md.26] Axis operation status".

The forced stop setting can be changed by "[Pr.82] Forced stop valid/invalid selection". "[Pr.82] Forced stop valid/invalid selection" and "forced stop input signal" are common with the servo amplifier axis.

## Command generation axis parameters

All command generation axis parameters are prepared for each command generation axis. However, change the parameters using GX Works3 or control data because the parameters are not in the buffer memory.

Setting item	Setting details	Setting value	Default value	Buffer memory address
[Pr.340] Command generation axis valid setting	<ul style="list-style-type: none"> <li>Set valid/invalid of the command generation axis to be used.</li> </ul> Fetch cycle: At power supply ON	■Set in decimal. 0: Invalid 1: Valid	0	—
[Pr.346] Command generation axis length per cycle	<ul style="list-style-type: none"> <li>Set the length per cycle of the command generation axis.</li> </ul> Fetch cycle: At power supply ON	■Set in decimal. 0: Invalid 1 to 2147483647 [Command generation axis position units*1]	0	—

\*1 Command generation axis position units (  Page 37 Command generation axis position units)

### [Pr.340] Command generation axis valid setting

Set valid/invalid of the command generation axis.

Setting value	Details
0: Invalid	Command generation axis is invalid.
1: Valid	Command generation axis is valid.

### [Pr.346] Command generation axis length per cycle

Set the length per cycle for the command generation axis current value per cycle.

The current value of command generation axis is stored in "[Md.347] Command generation axis current value per cycle" at ring counter based on the setting value.

The unit settings are in command generation axis position units (  Page 37 Command generation axis position units).

Set a value within the range from 1 to 2147483647. If a value out of the range is input, the axis error "Outside command generation axis length per cycle setting error" (error code: 1BADH [FX5-SSC-S], or error code: 1DFDH [FX5-SSC-G]) occurs and the axis operates as that the length per cycle is 0.

If "0" is set, "[Md.347] Command generation axis current value per cycle" is not updated.



## List of parameters that can be used

Each parameter specification is common with the servo amplifier axis. For specification details, refer to "MAJOR POSITIONING CONTROL" in the following manual.

📖 MELSEC iQ-F FX5 Motion Module/Simple Motion Module User's Manual (Application)

○: Available, ×: Not available

### ■ Servo network configuration parameters [FX5-SSC-G]

Name	Servo amplifier axis	Command generation axis
[Pr.101] Virtual servo amplifier setting	○	×
[Pr.140] Driver command discard detection setting	○	×
[Pr.141] IP address	○	×
[Pr.142] Multidrop number	○	×

### ■ Common parameters

Name	Servo amplifier axis	Command generation axis
[Pr.24] Manual pulse generator/Incremental synchronous encoder input selection [FX5-SSC-S]	○	×
[Pr.82] Forced stop valid/invalid selection	○: Servo amplifier axis and command generation axis in common	
[Pr.89] Manual pulse generator/Incremental synchronous encoder input type selection [FX5-SSC-S]	○	×
[Pr.96] Operation cycle setting [FX5-SSC-S]	○: Servo amplifier axis and command generation axis in common	
[Pr.97] SSCNET setting [FX5-SSC-S]	○	×
[Pr.150] Input terminal logic selection [FX5-SSC-S]	○	×
[Pr.151] Manual pulse generator/ Incremental synchronous encoder input logic selection [FX5-SSC-S]	○	×
[Pr.152] Control axis number upper limit [FX5-SSC-G]	○	×
[Pr.156] Manual pulse generator smoothing time constant [FX5-SSC-G]	○	×

### ■ Basic parameters1

Name	Servo amplifier axis	Command generation axis
[Pr.1] Unit setting	○	○: Fetch cycle is at power supply ON.
[Pr.2] Number of pulses per rotation (AP)	○	×
[Pr.3] Movement amount per rotation (AL)	○	×
[Pr.4] Unit magnification (AM)	○	×
[Pr.7] Bias speed at start	○	×

### ■ Basic parameters2

Name	Servo amplifier axis	Command generation axis
[Pr.8] Speed limit value	○	○
[Pr.9] Acceleration time 0	○	○
[Pr.10] Deceleration time 0	○	○

## ■Detailed parameters1

Name	Servo amplifier axis	Command generation axis
[Pr.11] Backlash compensation amount	○	×
[Pr.12] Software stroke limit upper limit value	○	○: Initial value 0*1
[Pr.13] Software stroke limit lower limit value	○	○: Initial value 0*1
[Pr.14] Software stroke limit selection	○	×
[Pr.15] Software stroke limit valid/invalid setting	○	○: Initial value 1*1
[Pr.16] Command in-position width	○	○
[Pr.17] Torque limit setting value	○	×
[Pr.18] M code ON signal output timing	○	○
[Pr.19] Speed switching mode	○	○
[Pr.20] Interpolation speed designation method	○	×
[Pr.21] Feed current value during speed control	○	×
[Pr.22] Input signal logic selection	b0: Lower limit	○
	b1: Upper limit	○
	b3: Stop signal	○
	b6: Proximity dog signal	○
[Pr.81] Speed-position function selection	○	×
[Pr.116] FLS signal selection	○	×
[Pr.117] RLS signal selection	○	×
[Pr.118] DOG signal selection	○	×
[Pr.119] STOP signal selection	○	×

\*1 Different from the servo amplifier axis, the initial value of software stroke limit is invalid.

\*2 It operates fixed to 1.

## ■Detailed parameters2

Name	Servo amplifier axis	Command generation axis
[Pr.25] Acceleration time 1	○	○
[Pr.26] Acceleration time 2	○	○
[Pr.27] Acceleration time 3	○	○
[Pr.28] Deceleration time 1	○	○
[Pr.29] Deceleration time 2	○	○
[Pr.30] Deceleration time 3	○	○
[Pr.31] JOG speed limit value	○	○
[Pr.32] JOG operation acceleration time selection	○	○
[Pr.33] JOG operation deceleration time selection	○	○
[Pr.34] Acceleration/deceleration process selection	○	○
[Pr.35] S-curve ratio	○	○
[Pr.36] Rapid stop deceleration time	○	○
[Pr.37] Stop group 1 rapid stop selection	○	×
[Pr.38] Stop group 2 rapid stop selection	○	○
[Pr.39] Stop group 3 rapid stop selection	○	○
[Pr.40] Positioning complete signal output time	○	○
[Pr.41] Allowable circular interpolation error width	○	×
[Pr.42] External command function selection	○	×
[Pr.83] Speed control 10 times multiplier setting for degree axis	○	○
[Pr.84] Restart allowable range when servo OFF to ON	○	×
[Pr.90] Operation setting for speed-torque control mode	b4 to b7: Torque initial value selection	○
	b8 to b11: Speed initial value selection	○
	b12 to b15: Condition selection at mode switching	○
[Pr.95] External command signal selection	○	×
[Pr.127] Speed limit value input selection at control mode switching	○	×

## ■Home position return basic parameters

Name	Servo amplifier axis	Command generation axis
[Pr.43] Home position return method	<input type="radio"/>	×
[Pr.44] Home position return direction	<input type="radio"/>	×
[Pr.45] Home position address	<input type="radio"/>	×
[Pr.46] Home position return speed	<input type="radio"/>	×
[Pr.47] Creep speed [FX5-SSC-S]	<input type="radio"/>	×
[Pr.48] Home position return retry [FX5-SSC-S]	<input type="radio"/>	×

## ■Home position return detailed parameters

Name	Servo amplifier axis	Command generation axis
[Pr.50] Setting for the movement amount after proximity dog ON [FX5-SSC-S]	<input type="radio"/>	×
[Pr.51] Home position return acceleration time selection	<input type="radio"/>	×
[Pr.52] Home position return deceleration time selection	<input type="radio"/>	×
[Pr.53] Home position shift amount [FX5-SSC-S]	<input type="radio"/>	×
[Pr.54] Home position return torque limit value [FX5-SSC-S]	<input type="radio"/>	×
[Pr.55] Operation setting for incompleteness of home position return	<input type="radio"/>	×
[Pr.56] Speed designation during home position shift [FX5-SSC-S]	<input type="radio"/>	×
[Pr.57] Dwell time during home position return retry [FX5-SSC-S]	<input type="radio"/>	×

## ■Extended parameters

Name	Servo amplifier axis	Command generation axis
[Pr.91] Optional data monitor: Data type setting 1	<input type="radio"/>	×
[Pr.92] Optional data monitor: Data type setting 2	<input type="radio"/>	×
[Pr.93] Optional data monitor: Data type setting 3	<input type="radio"/>	×
[Pr.94] Optional data monitor: Data type setting 4	<input type="radio"/>	×
[Pr.512] Optional SDO 1 [FX5-SSC-G]	<input type="radio"/>	×
[Pr.591] Optional data monitor: Data type expansion setting 1 [FX5-SSC-G]	<input type="radio"/>	×
[Pr.592] Optional data monitor: Data type expansion setting 2 [FX5-SSC-G]	<input type="radio"/>	×
[Pr.593] Optional data monitor: Data type expansion setting 3 [FX5-SSC-G]	<input type="radio"/>	×
[Pr.594] Optional data monitor: Data type expansion setting 4 [FX5-SSC-G]	<input type="radio"/>	×

## Command generation axis control data

All command generation axis control data is prepared for each command generation axis.

n: Axis No. - 1

Setting item	Setting details	Setting value	Default value	Buffer memory address
[Cd.300] Command generation axis parameter No. designation	Specify the parameter No. to be written.	■Set in decimal. Parameter No. 1 to 400	0	61970+128n
[Cd.301] Command generation axis parameter setting value	Specify the setting value to be written.	■Set in decimal. -2147483648 to 2147483647	0	61972+128n 61973+128n
[Cd.302] Command generation axis parameter control request	Set the writing command.	■Set in hexadecimal. 0000H: Not request 0001H: Write request 0002H: Read request FFFFH: Write/read error	0000H	61971+128n
[Cd.303] Command generation axis positioning data No. designation	Specify the positioning data No. to be written.	■Set in decimal. Data No. 1 to 100	0	61974+128n
[Cd.304] Command generation axis positioning data designation	Specify [Da._] of the positioning data No. to be written (positioning data, block start data, condition data).	■Set in decimal. Data No. specification [Da.1]: 1 [Da.2]: 2 : [Da.26]: 26	0	61975+128n
[Cd.305] Command generation axis positioning data setting value	Specify the setting value to be written.	■Set in decimal. -2147483648 to 2147483647	0	61976+128n 61977+128n
[Cd.306] Command generation axis positioning data control request	Set the writing command.	■Set in hexadecimal. 0000H: Not request 0001H: Write request 0002H: Read request FFFFH: Write/read error	0000H	61978+128n

### [Cd.300] to [Cd.302] Command generation axis parameter

Refer to the following for details.

 Page 52 Write/read method for command generation axis parameter and positioning data

### [Cd.303] to [Cd.306] Command generation axis positioning data

Refer to the following for details.

 Page 52 Write/read method for command generation axis parameter and positioning data

## List of control data that can be used

The specification is common with the servo amplifier axis. For specification details, refer to "MAJOR POSITIONING CONTROL" in the following manual.

 MELSEC iQ-F FX5 Motion Module/Simple Motion Module User's Manual (Application)

○: Available, ×: Not available

### ■System control data

Name	Servo amplifier axis	Command generation axis
[Cd.1] Flash ROM write request	○: Servo amplifier axis and command generation axis in common	
[Cd.2] Parameter initialization request	○: Servo amplifier axis and command generation axis in common	
[Cd.41] Deceleration start flag valid	○: Servo amplifier axis and command generation axis in common	
[Cd.42] Stop command processing for deceleration stop selection	○: Servo amplifier axis and command generation axis in common	
[Cd.44] External input signal operation device (Axis 1 to 8)	○	×
[Cd.55] Input value for manual pulse generator via CPU [FX5-SSC-G]	○	×
[Cd.102] SSCNET control command [FX5-SSC-S]	○	×
[Cd.137] Amplifier-less operation mode switching request [FX5-SSC-S]	○	×
[Cd.158] Forced stop input [FX5-SSC-G]	○	×
[Cd.190] PLC READY signal	○: Servo amplifier axis and command generation axis in common	
[Cd.191] All axis servo ON signal	○	×

### ■Axis control data

The buffer memory address is different for the data that can be used with the servo amplifier axis and the command generation axis. For the buffer memory addresses of the servo amplifier axis, refer to "List of Buffer Memory Addresses" in the following manual.

 MELSEC iQ-F FX5 Motion Module/Simple Motion Module User's Manual (Application)

For the buffer memory addresses of the command generation axis, refer to the following.

 Page 169 List of Buffer Memory Addresses (for Synchronous Control)

Name	Servo amplifier axis	Command generation axis
[Cd.3] Positioning start No.	○	○*1
[Cd.4] Positioning starting point No.	○	×
[Cd.5] Axis error reset	○	○
[Cd.6] Restart command	○	○
[Cd.7] M code OFF request	○	○
[Cd.8] External command valid	○	×
[Cd.9] Current value change	○	○
[Cd.10] New acceleration time value	○	○
[Cd.11] New deceleration time value	○	○
[Cd.12] Acceleration/deceleration time change value during speed change, enable/disable	○	○
[Cd.13] Positioning operation speed override	○	○
[Cd.14] New speed value	○	○
[Cd.15] Speed change request	○	○
[Cd.16] Inching movement amount	○	×
[Cd.17] JOG speed	○	○
[Cd.18] Interrupt request during continuous operation	○	○
[Cd.19] Home position return request flag OFF request	○	×
[Cd.20] Manual pulse generator 1 pulse input magnification	○	×
[Cd.21] Manual pulse generator enable flag	○	×
[Cd.22] New torque value/forward new torque value	○	×
[Cd.23] Speed-position switching control movement amount change register	○	○
[Cd.24] Speed-position switching enable flag	○	○
[Cd.25] Position-speed switching control speed change register	○	×
[Cd.26] Position-speed switching enable flag	○	×

Name	Servo amplifier axis	Command generation axis
[Cd.27] Target position change value (New address)	○	○
[Cd.28] Target position change value (New speed)	○	○
[Cd.29] Target position change request flag	○	○
[Cd.30] Simultaneous starting own axis start data No.	○	×
[Cd.31] Simultaneous starting axis start data No.1	○	×
[Cd.32] Simultaneous starting axis start data No.2	○	×
[Cd.33] Simultaneous starting axis start data No.3	○	×
[Cd.34] Step mode	○	×
[Cd.35] Step valid flag	○	×
[Cd.36] Step start information	○	×
[Cd.37] Skip command	○	×
[Cd.38] Teaching data selection	○	×
[Cd.39] Teaching positioning data No.	○	×
[Cd.40] ABS direction in degrees	○	○
[Cd.43] Simultaneous starting axis	○	×
[Cd.45] Speed-position switching device selection	○	×*2
[Cd.46] Speed-position switching command	○	○
[Cd.100] Servo OFF command	○	×
[Cd.101] Torque output setting value	○	×
[Cd.108] Gain changing command flag	○	×
[Cd.112] Torque change function switching request	○	×
[Cd.113] Reverse new torque value	○	×
[Cd.130] Servo parameter write request [FX5-SSC-S]	○	×
[Cd.131] Parameter No. (Setting for servo parameters to be changed) [FX5-SSC-S]	Parameter No. setting	○
	Parameter group	
	Writing mode	
[Cd.132] Change data [FX5-SSC-S]	○	×
[Cd.136] PI-PID switching request	○	×
[Cd.138] Control mode switching request	○	×
[Cd.139] Control mode setting	○	×
[Cd.140] Command speed at speed control mode	○	×
[Cd.141] Acceleration time at speed control mode	○	×
[Cd.142] Deceleration time at speed control mode	○	×
[Cd.143] Command torque at torque control mode	○	×
[Cd.144] Torque time constant at torque control mode (Forward direction)	○	×
[Cd.145] Torque time constant at torque control mode (Negative direction)	○	×
[Cd.146] Speed limit value at torque control mode	○	×
[Cd.147] Speed limit value at continuous operation to torque control mode	○	×
[Cd.148] Acceleration time at continuous operation to torque control mode	○	×
[Cd.149] Deceleration time at continuous operation to torque control mode	○	×
[Cd.150] Target torque at continuous operation to torque control mode	○	×
[Cd.151] Torque time constant at continuous operation to torque control mode (Forward direction)	○	×
[Cd.152] Torque time constant at continuous operation to torque control mode (Negative direction)	○	×
[Cd.153] Control mode auto-shift selection	○	×
[Cd.154] Control mode auto-shift parameter	○	×
[Cd.180] Axis stop	○	○
[Cd.181] Forward run JOG start	○	○
[Cd.182] Reverse run JOG start	○	○
[Cd.183] Execution prohibition flag	○	×
[Cd.184] Positioning start	○	○

\*1 The setting range is 1 to 100: Positioning data No. and 9003: Current value changing.

\*2 It is fixed to the initial value 2.

## ■Axis control data (transient function) [FX5-SSC-G]

Name	Servo amplifier axis	Command generation axis
[Cd.160] Command send request 1	○	×
[Cd.164] Optional SDO transfer data 1	○	×

## Command generation axis monitor data

n: Axis No. - 1

Monitor item	Storage details	Monitor value	Buffer memory address
[Md.345] Command generation axis accumulative current value	The accumulative current value for the command generation axis is stored. <u>Refresh cycle: Operation cycle</u>	■Monitoring is carried out in decimal. -2147483648 to 2147483647 [Command generation axis position units* <sup>1</sup> ]	61000+120n 61001+120n
[Md.347] Command generation axis current value per cycle	The current value per cycle for the command generation axis is stored. <u>Refresh cycle: Operation cycle</u>	■Monitoring is carried out in decimal. 0 to (Command generation axis length per cycle - 1) [Command generation axis position units* <sup>1</sup> ]	61002+120n 61003+120n

\*1 Command generation axis position units (  Page 37 Command generation axis position units)

### [Md.345] Command generation axis accumulative current value

The accumulative current value for the command generation axis is stored in the "[Pr.1] Unit setting". The axis whose unit setting is other than "degree" is set to "feed current value = accumulative current value".

### [Md.347] Command generation axis current value per cycle

The current value per cycle for the command generation axis is stored in the range from 0 to ("[Pr.346] Command generation axis length per cycle" - 1).



## List of monitor data that can be used

The specification is common with the servo amplifier axis. For specification details, refer to "MAJOR POSITIONING CONTROL" in the following manual.

📖 MELSEC iQ-F FX5 Motion Module/Simple Motion Module User's Manual (Application)

○: Available, ×: Not available

### ■ System monitor data

Name		Servo amplifier axis	Command generation axis
[Md.3] Start information	Start history	○	×
[Md.4] Start No.		○	×
[Md.54] Start (Year: month)		○	×
[Md.5] Start (Day: hour)		○	×
[Md.6] Start (Minute: second)		○	×
[Md.60] Start (ms)		○	×
[Md.7] Error judgment		○	×
[Md.8] Start history pointer		○	×
[Md.19] Number of write accesses to flash ROM		○: Servo amplifier axis and command generation axis in common	
[Md.50] Forced stop input		○: Servo amplifier axis and command generation axis in common	
[Md.51] Amplifier-less operation mode status [FX5-SSC-S]		○	×
[Md.52] Communication between amplifiers axes searching flag [FX5-SSC-S]		○	×
[Md.53] SSCNET control status [FX5-SSC-S]		○	×
[Md.59] Module information		○	×
[Md.130] F/W version		○: Servo amplifier axis and command generation axis in common	
[Md.131] Digital oscilloscope running flag		○: Servo amplifier axis and command generation axis in common	
[Md.132] Operation cycle setting		○: Servo amplifier axis and command generation axis in common	
[Md.133] Operation cycle over flag		○: Servo amplifier axis and command generation axis in common	
[Md.134] Operation time		○: Servo amplifier axis and command generation axis in common	
[Md.135] Maximum operation time		○: Servo amplifier axis and command generation axis in common	
[Md.140] Module status	b0: READY	○: Servo amplifier axis and command generation axis in common	
	b1: Synchronization flag	○: Servo amplifier axis and command generation axis in common	
[Md.141] BUSY	b0: Axis 1 BUSY	○	○*1
	b1: Axis 2 BUSY		
	b2: Axis 3 BUSY		
	b3: Axis 4 BUSY		
	b4: Axis 5 BUSY		
	b5: Axis 6 BUSY		
	b6: Axis 7 BUSY		
	b7: Axis 8 BUSY		

\*1 The command generation axis is different from the servo amplifier axis in that the command generation axis stores the buffer memory address in each axis.

## ■Axis monitor data

Name		Servo amplifier axis	Command generation axis
[Md.20]	Feed current value	○	○
[Md.21]	Machine feed value	○	×
[Md.22]	Feedrate	○	○
[Md.23]	Axis error No.	○	○
[Md.24]	Axis warning No.	○	○
[Md.25]	Valid M code	○	○
[Md.26]	Axis operation status	○	○
[Md.27]	Current speed	○	○
[Md.28]	Axis feedrate	○	○
[Md.29]	Speed-position switching control positioning movement amount	○	○
[Md.30]	External input signal		
	b0: Lower limit signal	○	×
	b1: Upper limit signal	○	×
	b3: Stop signal	○	×
	b4: External command signal/switching signal	○	×
[Md.31]	Status		
	b0: In speed control flag	○	○
	b1: Speed-position switching latch flag	○	○
	b2: Command in-position flag	○	○
	b3: Home position return request flag	○	×
	b4: Home position return complete flag	○	×
	b5: Position-speed switching latch flag	○	×
	b9: Axis warning detection	○	○
	b10: Speed change 0 flag	○	○
	b12: M code ON	○	○
	b13: Error detection	○	○
	b14: Start complete	○	○
b15: Positioning complete	○	○	
[Md.32]	Target value	○	○
[Md.33]	Target speed	○	○
[Md.34]	Movement amount after proximity dog ON [FX5-SSC-S]	○	×
[Md.35]	Torque limit stored value/forward torque limit stored value	○	×
[Md.36]	Special start data instruction code setting value	○	×
[Md.37]	Special start data instruction parameter setting value	○	×
[Md.38]	Start positioning data No. setting value	○	○
[Md.39]	In speed limit flag	○	○
[Md.40]	In speed change processing flag	○	○
[Md.41]	Special start repetition counter	○	×
[Md.42]	Control system repetition counter	○	○
[Md.43]	Start data pointer being executed	○	×
[Md.44]	Positioning data No. being executed	○	○
[Md.45]	Block No. being executed	○	×
[Md.46]	Last executed positioning data No.	○	○
[Md.47]	Positioning data being executed		
	Positioning identifier	○	○
	Positioning address	○	○
	Arc address	○	×
	Command speed	○	○
	Dwell time	○	○
[Md.47]	M code	○	○
	Axis to be interpolated	○	×
[Md.48]	Deceleration start flag	○	○
[Md.100]	Home position return re-travel value [FX5-SSC-S]	○	×

Name	Servo amplifier axis	Command generation axis
[Md.101] Real current value	○	×
[Md.102] Deviation counter value	○	×
[Md.103] Motor rotation speed	○	×
[Md.104] Motor current value	○	×
[Md.106] Servo amplifier software No. [FX5-SSC-S]	○	×
[Md.107] Parameter error No. [FX5-SSC-S]	○	×
[Md.108] Servo status1		
b0: READY ON	○	×
b1: Servo ON	○	×
b2, b3: Control mode	○	×
b7: Servo alarm	○	×
b12: In-position	○	×
b13: Torque limit	○	×
b14: Absolute position lost	○	×
b15: Servo warning	○	×
[Md.109] Regenerative load ratio/Optional data monitor output 1	○	×
[Md.110] Effective load torque/Optional data monitor output 2	○	×
[Md.111] Peak torque ratio/Optional data monitor output 3	○	×
[Md.112] Optional data monitor output 4	○	×
[Md.113] Semi/Fully closed loop status	○	×
[Md.114] Servo alarm	○	×
[Md.115] Servo alarm detail number [FX5-SSC-G]	○	×
[Md.116] Encoder option information	○	×
[Md.117] Statusword [FX5-SSC-G]	○	×
[Md.119] Servo status2		
b0: Zero point pass	○	×
b3: Zero speed	○	×
b4: Speed limit	○	×
b8: PID control	○	×
[Md.120] Reverse torque limit stored value	○	×
[Md.122] Speed during command	○	○
[Md.123] Torque during command	○	×
[Md.124] Control mode switching status	○	×
[Md.125] Servo status3	b14: Continuous operation to torque control mode	×
[Md.160] Optional SDO transfer result 1 [FX5-SSC-G]	○	×
[Md.164] Optional SDO transfer status 1 [FX5-SSC-G]	○	×
[Md.190] Controller current value restoration complete status [FX5-SSC-G]	○	×
[Md.500] Servo status7 [FX5-SSC-S]	○	×
[Md.502] Driver operation alarm No. [FX5-SSC-S]	○	×
[Md.514] Home position return operating status [FX5-SSC-G]	○	×

## Command generation axis positioning data

All positioning data is not in the buffer memory. Therefore, change the data using GX Works3 or control data. The specification of command generation axis positioning data is common with "major positioning controls". However, the positioning data is 100 points for each axis. The control methods that can be used are "ABS linear 1, INC linear 1, Forward run: speed 1, Reverse run: speed 1, Forward run: speed/position, Reverse run: speed/position".

For details of "major positioning controls", refer to "MAJOR POSITIONING CONTROL" in the following manual.

 MELSEC iQ-F FX5 Motion Module/Simple Motion Module User's Manual (Application)

### List of positioning data that can be used

The specification is common with the servo amplifier axis. For specification details, refer to "MAJOR POSITIONING CONTROL" in the following manual.

 MELSEC iQ-F FX5 Motion Module/Simple Motion Module User's Manual (Application)

○: Available, ×: Not available

#### ■Positioning data

Name	Servo amplifier axis	Command generation axis
[Da.1] Operation pattern	○	○
[Da.2] Control method	○	○
[Da.3] Acceleration time No.	○	○
[Da.4] Deceleration time No.	○	○
[Da.6] Positioning address/movement amount	○	○
[Da.7] Arc address	○	×
[Da.8] Command speed	○	○
[Da.9] Dwell time/JUMP destination positioning data No.	○	○
[Da.10] M code/Number of LOOP to LEND repetitions	○	○
[Da.10] Condition data No.	○	×
[Da.20] Axis to be interpolated No.1	○	×
[Da.21] Axis to be interpolated No.2	○	×
[Da.22] Axis to be interpolated No.3	○	×

#### Point

When the speed control is selected in "[Da.1] Operation pattern", set invalid to "[Pr.15] Software stroke limit valid/invalid setting" as necessary.

#### ■Setting range of "[Da.2] Control method"

Name	Servo amplifier axis	Command generation axis
01h: ABS linear 1	○	○
02h: INC linear 1	○	○
03h: Fixed-feed 1	○	×
04h: Forward run speed 1	○	○
05h: Reverse run speed 1	○	○
06h: Forward run speed/position	○	○
07h: Reverse run speed/position	○	○
08h: Forward run position/speed	○	×
09h: Reverse run position/speed	○	×
0Ah: ABS linear 2	○	×
0Bh: INC linear 2	○	×
0Ch: Fixed-feed 2	○	×
0Dh: ABS circular sub	○	×
0Eh: INC circular sub	○	×
0Fh: ABS circular right	○	×
10h: ABS circular left	○	×

Name	Servo amplifier axis	Command generation axis
11h: INC circular right	<input type="radio"/>	×
12h: INC circular left	<input type="radio"/>	×
13h: Forward run speed 2	<input type="radio"/>	×
14h: Reverse run speed 2	<input type="radio"/>	×
15h: ABS linear 3	<input type="radio"/>	×
16h: INC linear 3	<input type="radio"/>	×
17h: Fixed-feed 3	<input type="radio"/>	×
18h: Forward run speed 3	<input type="radio"/>	×
19h: Reverse run speed 3	<input type="radio"/>	×
1Ah: ABS linear 4	<input type="radio"/>	×
1Bh: INC linear 4	<input type="radio"/>	×
1Ch: Fixed-feed 4	<input type="radio"/>	×
1Dh: Forward run speed 4	<input type="radio"/>	×
1Eh: Reverse run speed 4	<input type="radio"/>	×
80h: NOP	<input type="radio"/>	<input type="radio"/>
81h: Current value changing	<input type="radio"/>	<input type="radio"/>
82h: JUMP instruction	<input type="radio"/>	<input type="radio"/>
83h: LOOP	<input type="radio"/>	<input type="radio"/>
84h: LEND	<input type="radio"/>	<input type="radio"/>

### ■Block start data

Name	Servo amplifier axis	Command generation axis
[Da.11] Shape	<input type="radio"/>	×
[Da.12] Start data No.	<input type="radio"/>	×
[Da.13] Special start instruction	<input type="radio"/>	×
[Da.14] Parameter	<input type="radio"/>	×

### ■Condition data

Name	Servo amplifier axis	Command generation axis
[Da.15] Condition target	<input type="radio"/>	×
[Da.16] Condition operator	<input type="radio"/>	×
[Da.17] Address	<input type="radio"/>	×
[Da.18] Parameter 1	<input type="radio"/>	×
[Da.19] Parameter 2	<input type="radio"/>	×
[Da.23] Number of simultaneously starting axes	<input type="radio"/>	×
[Da.24] Simultaneously starting axis No.1	<input type="radio"/>	×
[Da.25] Simultaneously starting axis No.2	<input type="radio"/>	×
[Da.26] Simultaneously starting axis No.3	<input type="radio"/>	×

# Write/read method for command generation axis parameter and positioning data

The command generation axis parameter and positioning data are not stored in the buffer memory, so that each setting value changes by the control data. The fetch timing of each parameter and positioning data is in accordance with each specification. Therefore, some parameter is not used for control until PLC READY ON or the power supply ON.

## Point

- Execute the writing of the parameter and positioning data by the write method procedure shown below. If the writing order is wrong, an unpredictable value might be set.
- The command generation axis control data and positioning data written by this method are erased at the power supply OFF. When it is necessary to save the data, write to the flash ROM of the Simple Motion module/Motion module by "[Cd.1] Flash ROM write request".

## Write method for command generation axis parameter

1. Specify the command generation axis parameter No. to "[Cd.300] Command generation axis parameter No. designation".
2. When "340" is set, "[Pr.340] Command generation axis valid setting" is specified. When "1" is set, "[Pr.1] Unit setting" is specified.
3. Specify the setting value to the command generation axis parameter with 2 words in "[Cd.301] Command generation axis parameter setting value".
4. Set "1: Write request" to "[Cd.302] Command generation axis parameter control request".
5. "[Cd.301] Command generation axis parameter setting value" is written to the command generation axis parameter No. specified in "[Cd.300] Command generation axis parameter No. designation". When the writing is succeeded, "0: Not request" is set in "[Cd.302] Command generation axis parameter control request".
6. When the parameter No. which is not defined to the command generation axis is specified, "FFFFH: Write/read error" is set in "[Cd.302] Command generation axis parameter control request". "[Cd.302] Command generation axis parameter control request" is detected always. It is not required to return to "0: Not request" from "FFFFH: Write/read error" manually.
7. The command generation axis control data and positioning data written by this method are erased at the power supply OFF. When it is necessary to save the data, write to the flash ROM of the Simple Motion module/Motion module by "[Cd.1] Flash ROM write request".

The timing that the command generation axis parameter to be written becomes valid is common with the servo amplifier axis. For specification details, refer to "MAJOR POSITIONING CONTROL" in the following manual.

MESEK iQ-F FX5 Motion Module/Simple Motion Module User's Manual (Application)

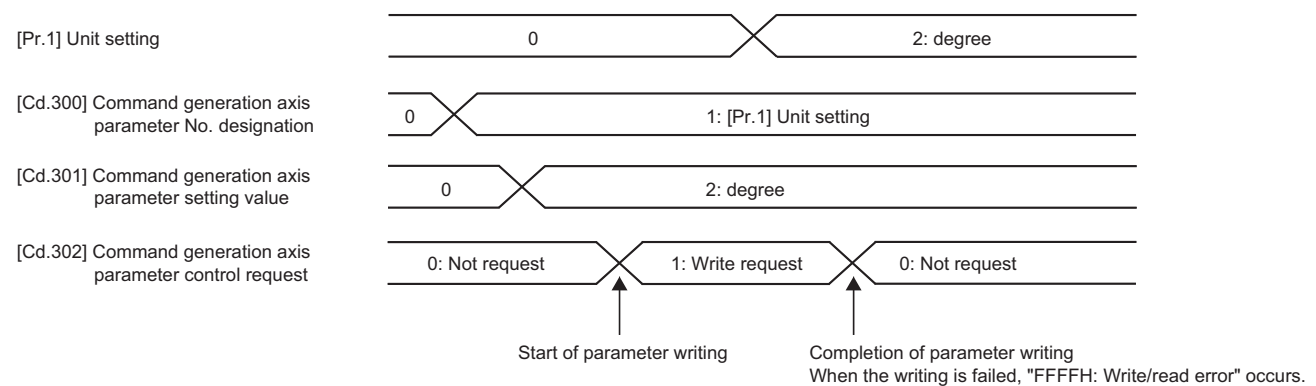

## Read method for command generation axis parameter

1. Specify the command generation axis parameter No. to "[Cd.300] Command generation axis parameter No. designation".
2. Set "2: Read request" to "[Cd.302] Command generation axis parameter control request".
3. The setting value to the command generation axis parameter is read with 2 words in "[Cd.301] Command generation axis parameter setting value". "0: Not request" is set in "[Cd.302] Command generation axis parameter control request".
4. When the parameter No. which is not defined to the command generation axis is specified, "FFFFH: Write/read error" is set in "[Cd.302] Command generation axis parameter control request". "[Cd.302] Command generation axis parameter control request" is detected always. It is not required to return to "0: Not request" from "FFFFH: Write/read error" manually.

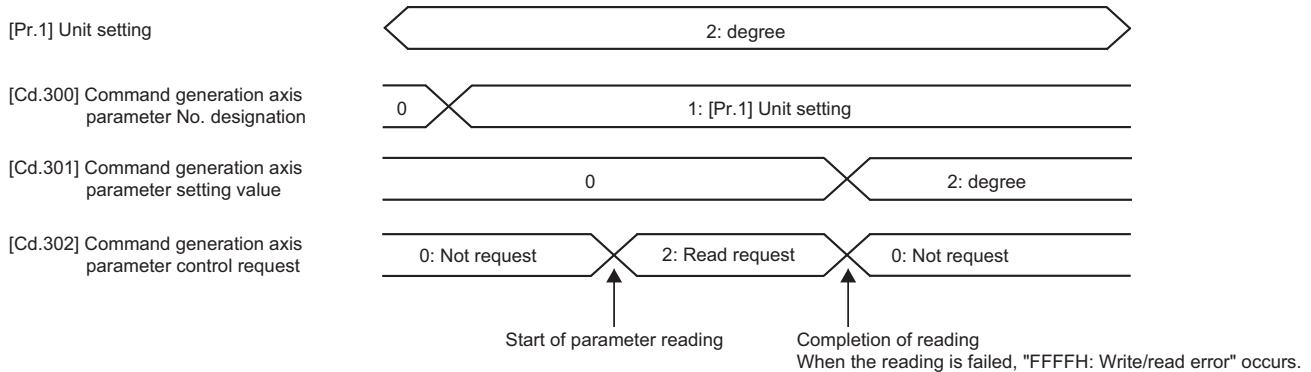

## Write method for command generation axis positioning data

1. Specify the command generation axis positioning data No. to "[Cd.303] Command generation axis positioning data No. designation". When "1" is set, "1" of the positioning data is specified.
2. Specify the command generation axis positioning data [Da.\_] to "[Cd.304] Command generation axis positioning data designation". When "1" is set, "[Da.1] Operation pattern" is specified.
3. Specify the setting value to the command generation axis positioning data No. and the command generation axis positioning data with 2 words to the low-order without space in "[Cd.305] Command generation axis positioning data setting value". To write ABS linear 1 in "[Da.2] Control method", specify "0000 0001H". When "0000 0100H" is specified, "0" is written.
4. Set "1: Write request" to "[Cd.306] Command generation axis positioning data control request". "[Cd.305] Command generation axis positioning data setting value" is written to the positioning data of the command generation axis positioning data No. specified in "[Cd.303] Command generation axis positioning data No. designation" and "[Cd.304] Command generation axis positioning data designation". When the writing is succeeded, "0: Not request" is set in "[Cd.306] Command generation axis positioning data control request".
5. When the positioning data No. and the positioning data which are not defined to the command generation axis are specified, "FFFFH: Write/read error" is set in "[Cd.306] Command generation axis positioning data control request". "[Cd.306] Command generation axis positioning data control request" is detected always. It is not required to return to "0: Not request" from "FFFFH: Write/read error" manually.
6. The command generation axis control data and positioning data written by this method are erased at the power supply OFF. When it is necessary to save the data, write to the flash ROM of the Simple Motion module/Motion module by "[Cd.1] Flash ROM write request".

The timing that the command generation axis positioning data to be written becomes valid is common with the servo amplifier axis. For specification details, refer to "MAJOR POSITIONING CONTROL" in the following manual.

📖 MELSEC iQ-F FX5 Motion Module/Simple Motion Module User's Manual (Application)

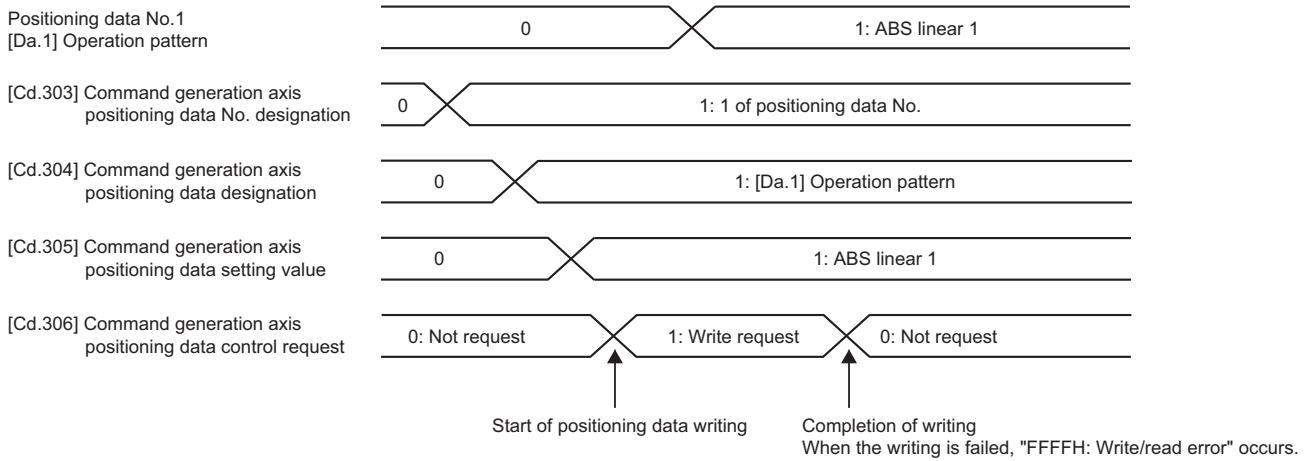

## Read method for command generation axis positioning data

1. Specify the command generation axis positioning data No. to "[Cd.303] Command generation axis positioning data No. designation". When "1" is set, "1" of the positioning data is specified.
2. Specify the command generation axis positioning data [Da. \_] to "[Cd.304] Command generation axis positioning data designation". When "1" is set, "[Da.1] Operation pattern" is specified.
3. Set "2: Read request" to "[Cd.306] Command generation axis positioning data control request".
4. "[Cd.305] Command generation axis positioning data setting value" is read with 2 words to the positioning data of the command generation axis positioning data No. specified in "[Cd.303] Command generation axis positioning data No. designation" and "[Cd.304] Command generation axis positioning data designation". When the reading is succeeded, "0: Not request" is set in "[Cd.306] Command generation axis positioning data control request".
5. When the parameter No. which is not defined to the command generation axis is specified, "FFFFH: Write/read error" is set in "[Cd.306] Command generation axis positioning data control request". "[Cd.306] Command generation axis positioning data control request" is detected always. It is not required to return to "0: Not request" from "FFFFH: Write/read error" manually.

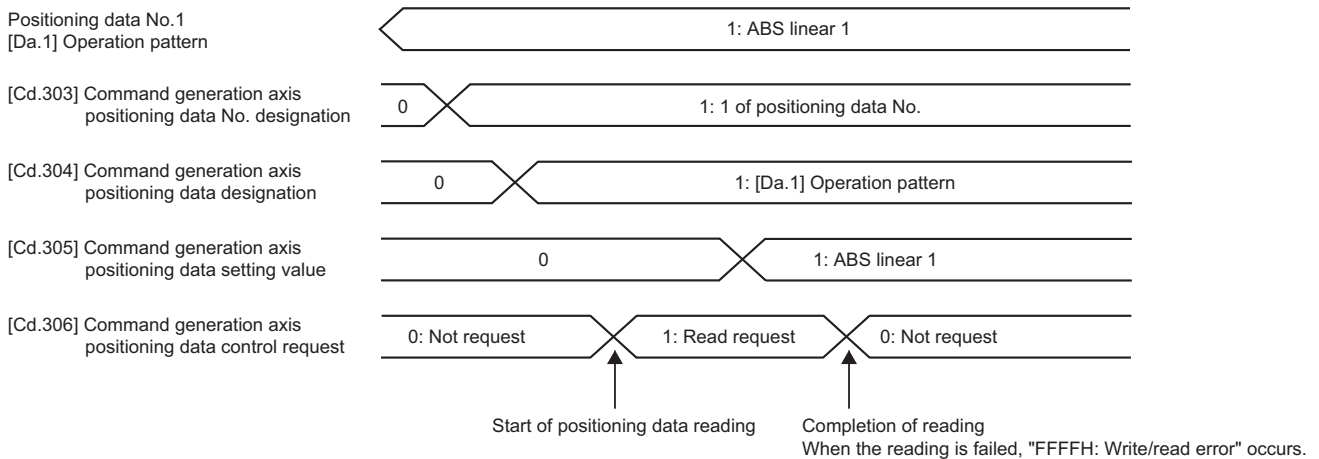



## 2.3 Synchronous Encoder Axis

### Overview of synchronous encoder axis

The synchronous encoder is used to drive the input axis based on input pulse from a synchronous encoder that is connected externally.

The status of a synchronous encoder axis can also be monitored after the system's power supply turns ON.

[FX5-SSC-S]

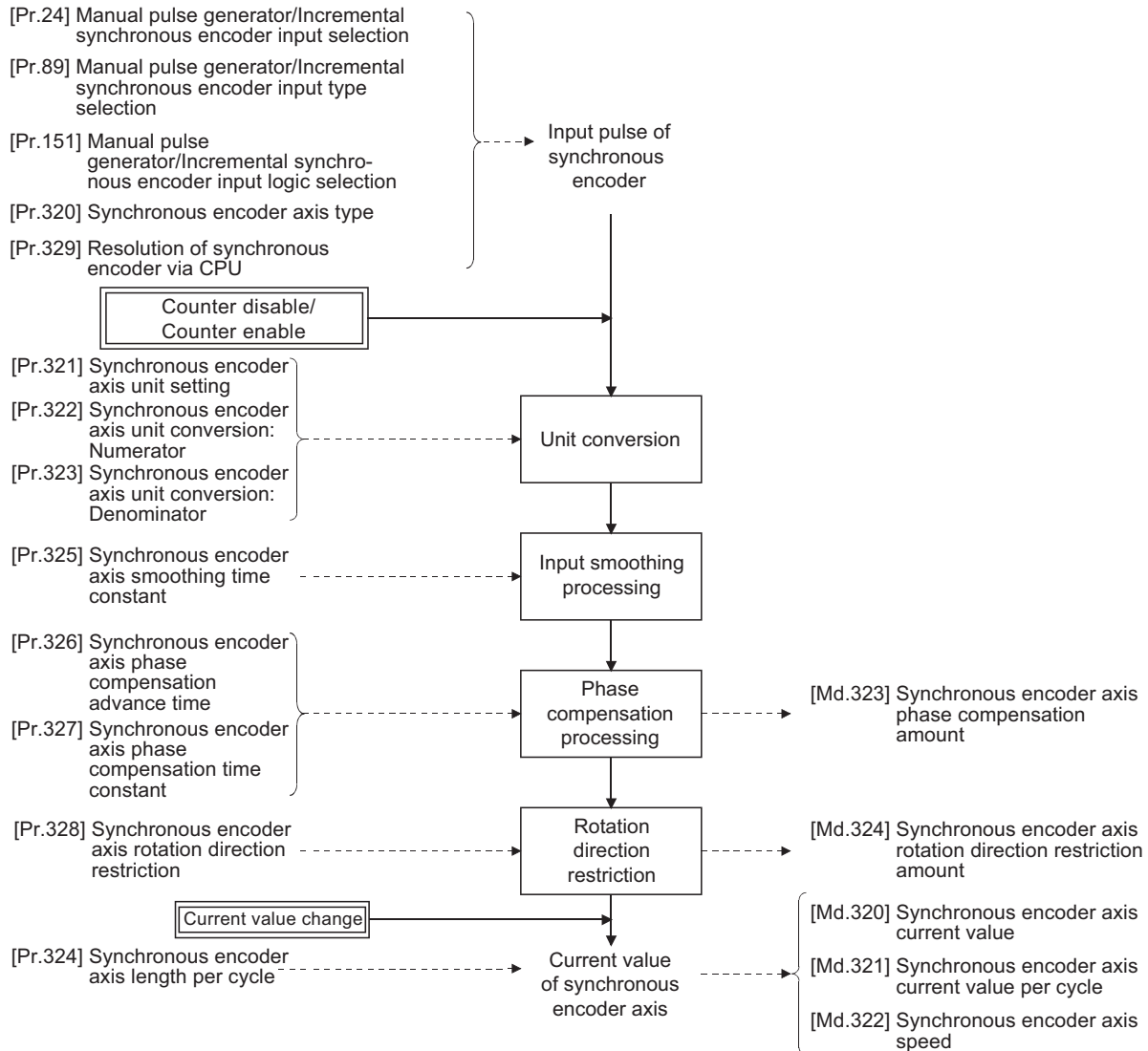

[FX5-SSC-G]

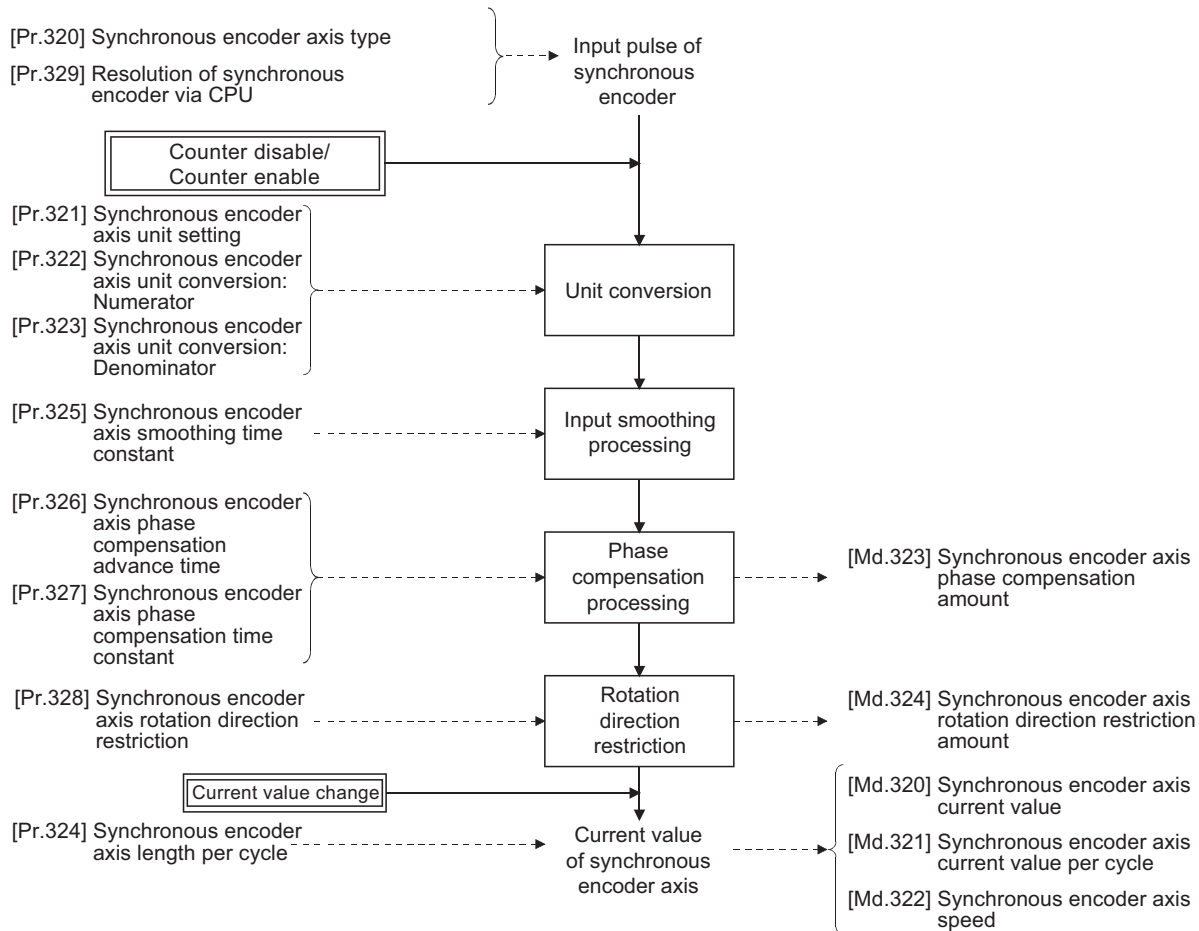

## Synchronous encoder axis type

The following 3 types of synchronous encoders can be used for the synchronous encoder axis.

Refer to the following for the setting method for each synchronous encoder axis.

☞ Page 59 Setting method for synchronous encoder

Synchronous encoder axis type	Details
Incremental synchronous encoder [FX5-SSC-S]	The incremental synchronous encoder that is connected to the manual pulse generator/incremental synchronous encoder input of the Simple Motion module is used as the synchronous encoder axis.
Synchronous encoder via servo amplifier	Used to use a synchronous encoder connected to the servo amplifier which supports the scale measurement mode as a synchronous encoder axis.
Synchronous encoder via CPU	Used to operate a gray code encoder that is connected to the input part of the CPU module or the extension input module as a synchronous encoder axis.

### Point

When using an incremental synchronous encoder with the FX5-SSC-G, connect the encoder with the input part of the CPU module or the extension high-speed pulse input/output module, then set "[Pr.320] Synchronous encoder axis type" to "201: Synchronous encoder via CPU"

## Control method for synchronous encoder axis

The following controls can be executed for the synchronous encoder axis by using "[Cd.320] Synchronous encoder axis control start" and "[Cd.321] Synchronous encoder axis control method".

Setting value of "[Cd.321] Synchronous encoder axis control method"	Control details
0: Current value change	"[Md.320] Synchronous encoder axis current value" and "[Md.321] Synchronous encoder axis current value per cycle" are changed based on the setting of "[Cd.322] Synchronous encoder axis current value setting address".
1: Counter disable	Input from the synchronous encoder is disabled.
2: Counter enable	Input from the synchronous encoder is enabled.

## Units for the synchronous encoder axis

The position units and speed units for the synchronous encoder axis are shown below for the setting of "[Pr.321] Synchronous encoder axis unit setting".

### ■Synchronous encoder axis position units

Setting value of "[Pr.321] Synchronous encoder axis unit setting"		Synchronous encoder axis position unit	Range
Control unit	Number of decimal places for position		
0: mm	0	mm	-2147483648 to 2147483647 [mm]
	⋮	⋮	⋮
	9	$\times 10^{-9}$ mm	-2.147483648 to 2.147483647 [mm]
1: inch	0	inch	-2147483648 to 2147483647 [inch]
	⋮	⋮	⋮
	9	$\times 10^{-9}$ inch	-2.147483648 to 2.147483647 [inch]
2: degree	0	degree	-2147483648 to 2147483647 [degree]
	⋮	⋮	⋮
	9	$\times 10^{-9}$ degree	-2.147483648 to 2.147483647 [degree]
3: pulse	0	pulse	-2147483648 to 2147483647 [pulse]
	⋮	⋮	⋮
	9	$\times 10^{-9}$ pulse	-2.147483648 to 2.147483647 [pulse]

### ■Synchronous encoder axis speed units

Setting value of "[Pr.321] Synchronous encoder axis unit setting"			Synchronous encoder axis speed unit	Range
Control unit	Speed time unit	Number of decimal places for speed		
0: mm	0: second [s]	0	mm/s	-2147483648 to 2147483647 [mm/s]
		⋮	⋮	⋮
		9	$\times 10^{-9}$ mm/s	-2.147483648 to 2.147483647 [mm/s]
	1: minute [min]	0	mm/min	-2147483648 to 2147483647 [mm/min]
		⋮	⋮	⋮
		9	$\times 10^{-9}$ mm/min	-2.147483648 to 2.147483647 [mm/min]
1: inch	0: second [s]	0	inch/s	-2147483648 to 2147483647 [inch/s]
		⋮	⋮	⋮
		9	$\times 10^{-9}$ inch/s	-2.147483648 to 2.147483647 [inch/s]
	1: minute [min]	0	inch/min	-2147483648 to 2147483647 [inch/min]
		⋮	⋮	⋮
		9	$\times 10^{-9}$ inch/min	-2.147483648 to 2.147483647 [inch/min]
2: degree	0: second [s]	0	degree/s	-2147483648 to 2147483647 [degree/s]
		⋮	⋮	⋮
		9	$\times 10^{-9}$ degree/s	-2.147483648 to 2.147483647 [degree/s]
	1: minute [min]	0	degree/min	-2147483648 to 2147483647 [degree/min]
		⋮	⋮	⋮
		9	$\times 10^{-9}$ degree/min	-2.147483648 to 2.147483647 [degree/min]
3: pulse	0: second [s]	0	pulse/s	-2147483648 to 2147483647 [pulse/s]
		⋮	⋮	⋮
		9	$\times 10^{-9}$ pulse/s	-2.147483648 to 2.147483647 [pulse/s]
	1: minute [min]	0	pulse/min	-2147483648 to 2147483647 [pulse/min]
		⋮	⋮	⋮
		9	$\times 10^{-9}$ pulse/min	-2.147483648 to 2.147483647 [pulse/min]

# Setting method for synchronous encoder

## Incremental synchronous encoder [FX5-SSC-S]

### ■Setting method

Connect the synchronous encoder to the "Manual pulse generator/Incremental synchronous encoder input" of the Simple Motion module.

Set the input method for the incremental synchronous encoder signal using the following parameters. (It may be common to use the same set up for the manual pulse generator input.)

- [Pr.24] Manual pulse generator/Incremental synchronous encoder input selection
- [Pr.89] Manual pulse generator/Incremental synchronous encoder input type selection
- [Pr.151] Manual pulse generator/Incremental synchronous encoder input logic selection

### Point

The synchronous encoder axis operates completely independently with the manual pulse generator operation. The parameter and control data for the manual pulse generator operation except the 3 parameters listed above has not influence on control of synchronous encoder axis. Therefore, they can also be controlled simultaneously by common input pulses.

When the synchronous encoder axis connection is valid after the system's power supply is ON, it will be "Synchronous encoder axis current value = 0", "Synchronous encoder axis current value per cycle = 0" and "Counter enabling status".

### ■Setting example

The following shows an example for setting an incremental synchronous encoder as synchronous encoder axis 2 of the Simple Motion module.

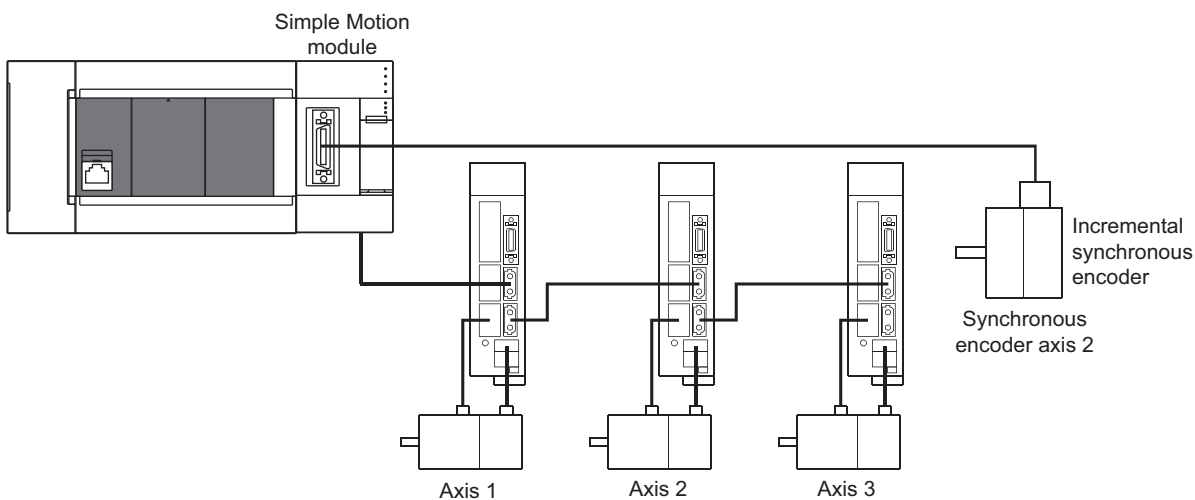

Set "1: Incremental synchronous encoder" in "[Pr.320] Synchronous encoder axis type" for the synchronous encoder axis 2. And, set the input method for incremental synchronous encoder signal in the following parameters.

- "[Pr.24] Manual pulse generator/Incremental synchronous encoder input selection": "0: A-phase/B-phase multiplied by 4"
- "[Pr.89] Manual pulse generator/Incremental synchronous encoder input type selection": "0: Differential output type"
- "[Pr.151] Manual pulse generator/Incremental synchronous encoder input logic selection": "0: Differential output type"

## Synchronous encoder via servo amplifier [FX5-SSC-S]

There are restrictions in the function and the encoder that can be used by the version of the servo amplifier.

### ■Setting method

Used to use a synchronous encoder connected to the servo amplifier which supports the scale measurement mode as a synchronous encoder axis.

The following servo amplifiers can be used. The servo amplifier must support the scale measurement function.

- MR-J4-B-RJ

Only a rotary encoder can be connected. Refer to the following servo amplifier instruction manuals for the version of the servo amplifier which supports the scale measurement function and the rotary encoder which can be used.

 SSCNETⅢ/H Interface AC Servo MR-J4-\_B\_(-RJ) Servo Amplifier Instruction Manual

A synchronous encoder connected to the specified servo amplifier axis can be used by the following settings.

Setting item	Setting method	Setting method of Simple Motion Module Setting Function
Synchronous encoder axis setting	Set "101 to 108: Synchronous encoder via servo amplifier (Connectable servo amplifier: axis 1 to axis 8 <sup>*1</sup> )" in "[Pr.320] Synchronous encoder axis type".	Set the synchronous encoder axis parameter according to the setting below. <ul style="list-style-type: none"> <li>• [Pr.320] Type</li> <li>101: Synchronous encoder via servo amplifier</li> <li>• [Pr.320] Axis No. of connected servo amplifier</li> <li>Axis No. of servo amplifier to connect</li> </ul>
Encoder type setting (Absolute/Incremental)	Set the servo parameter "Scale measurement mode selection (PA22)" according to the setting below. 0___H: Disabled 1___H: Used in absolute position detection system 2___H: Used in incremental system	Set "ABS" or "INC" from the "External synchronous encoder input" list of the amplifier setting dialog. (The amplifier setting dialog can be opened from the "System Configuration" window in the "System Setting".)

\*1 The range from axis 1 to 4 is valid in the 4-axis module and from axis 1 to 8 is valid in the 8-axis module.

When "1\_\_\_H" is set in the servo parameter "Scale measurement mode selection (PA22)", the synchronous encoder axis current value and the synchronous encoder axis current value per cycle are restored after the servo amplifier axis is connected. Therefore, connection becomes valid, and will be on the counter enabling status. (The current value setting by current value change is required beforehand.)

When "2\_\_\_H" is set in the servo parameter "Scale measurement mode selection (PA22)", "0" is set to the initial value of the synchronous encoder axis current value and the synchronous encoder axis current value per cycle after the servo amplifier axis is connected. Therefore, connection becomes valid, and will be on the counter enabling status.

If the corresponding servo amplifier axis is not connected, the connection of the synchronous encoder axis will be invalid.

### Point

When "1\_\_\_H" is set in the servo parameter "Scale measurement mode selection (PA22)" and the synchronous encoder movement amount (encoder pulse units) on disconnection or during the power supply OFF exceeds "2147483647" or "-2147483648", the synchronous encoder axis current value is restored with its opposite sign.

### ■Point of the setting method

- "Scale measurement mode selection (PA22)" is set to the servo amplifier set by "ABS" or "INC" from the "External synchronous encoder input" list of the amplifier setting dialog using the Simple Motion Module Setting Function.
- When the servo parameter "Scale measurement mode selection (PA22)" is changed, it is required to switch the power of servo amplifier off once after the parameter is transferred to the servo amplifier, and then switch it on again.
- If the servo amplifier set by the servo parameter "Scale measurement mode selection (PA22)" does not support the "Scale measurement mode", "AL.37" (parameter error) will occur in the servo amplifier. Refer to the servo amplifier instruction manual for details of the servo parameter "Scale measurement mode selection (PA22)".
- The synchronous encoder via servo amplifier can be controlled up to 4. However, there is no restriction for the number of connections. Therefore, the error check is not executed even when the external synchronous encoders are set more than 4 in the "System Setting" using the Simple Motion Module Setting Function.
- The following information of the synchronous encoder via servo amplifier can be output with the optional data monitor. The setting details of the optional data monitor for the synchronous encoder information are shown below.

Information of synchronous encoder	Setting detail for optional data monitor
Scale position within one-revolution	24: Load side encoder information 1 (Used point: 2words)
Scale absolute counter	25: Load side encoder information 2 (Used point: 2words)

- A serial absolute synchronous encoder Q171ENC-W8 can be used in an incremental system by setting "2\_ \_ \_H" in the servo parameter "Scale measurement mode selection (PA22)" even if the battery of the servo amplifier is dismantled.

## ■ Setting example

The following shows an example for setting a serial absolute synchronous encoder Q171ENC-W8 using MR-J4-\_B-RJ as synchronous encoder axis 1 of the Simple Motion module.

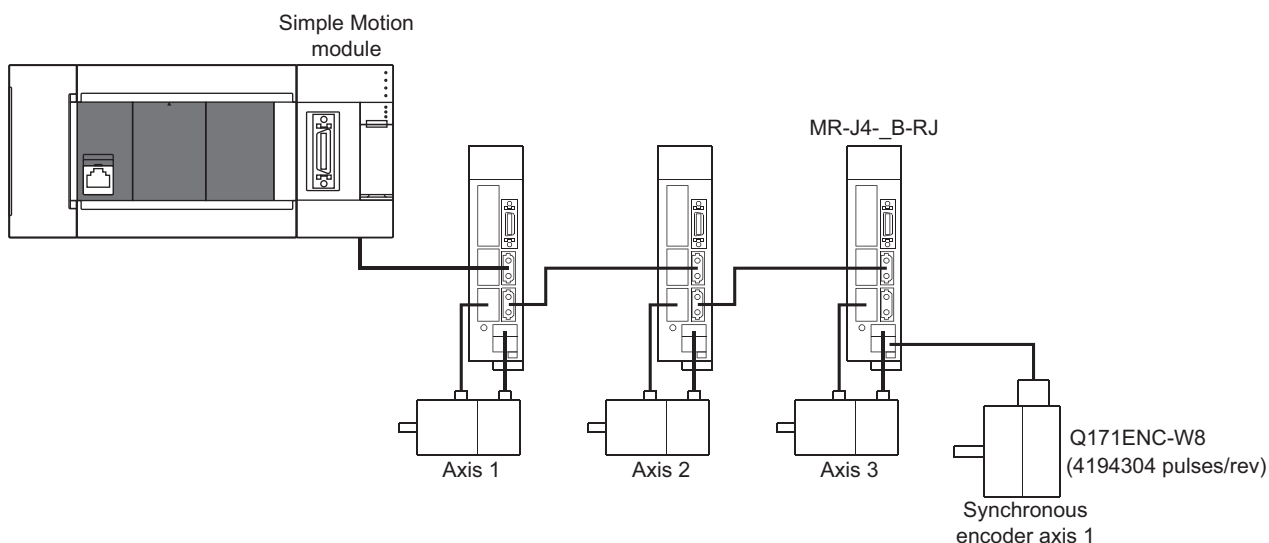

Set the parameters as below.

- Set "101: Synchronous encoder via servo amplifier (servo amplifier axis 1)" in "[Pr.320] Synchronous encoder axis type" of synchronous encoder axis 1.
- Set "32: MR-J4-\_B" in "[Pr.100] Servo series" of the axis to connect Q171ENC-W8.
- Set "1\_\_H" or "2\_\_H" in the servo parameter "Scale measurement mode selection (PA22)". (Set "ABS" or "INC" from the "External synchronous encoder input" list of the amplifier setting dialog using the Simple Motion Module Setting Function.)
- Set "1\_\_H" in the servo parameter "Function selection C-8 (PC26)".

## ■ Restrictions

- The servo amplifier axis selected as "Synchronous encoder via servo amplifier" in "[Pr.320] Synchronous encoder axis type" does not operate in the fully closed control mode even though "\_1\_H" is set in the servo parameter "Operation mode selection (PA01)".
- The information about the synchronous encoder is output to "[Md.112] Optional data monitor output 4" of the servo amplifier axis selected as "Synchronous encoder via servo amplifier" in "[Pr.320] Synchronous encoder axis type", and "[Pr.94] Optional data monitor: Data type setting 4" is ignored. (Set the total points to be within 3 words for the optional data monitor. Otherwise, the monitor setting is ignored.)
- When the servo alarms about the serial absolute synchronous encoder connection occur in the servo amplifier axis selected as "Synchronous encoder via servo amplifier" in "[Pr.320] Synchronous encoder axis type", the status becomes servo OFF. "AL.25" (Absolute position erased), "AL.70" (Load-side encoder initial communication error 1), or "AL.71" (Loadside encoder normal communication error 1) occurs in the servo amplifier.
- The error "Synchronous encoder via servo amplifier invalid error" (error code: 1BAAH) occurs in the following cases.
  - Other than "32: MR-J4-\_B" is set in "[Pr.100] Servo series" of the axis No. selected as "Synchronous encoder via servo amplifier" in "[Pr.320] Synchronous encoder axis type".
  - The servo amplifier axis which is not set in the system setting is set to the servo amplifier axis No. to connect to "Synchronous encoder via servo amplifier".
  - The servo axis, which "Invalid" is set to from the "External synchronous encoder input" list of the amplifier setting dialog using the Simple Motion Module Setting Function, is set to the servo amplifier axis No. to connect to "Synchronous encoder via servo amplifier".
  - A linear scale is connected.



## Synchronous encoder via servo amplifier [FX5-SSC-G]

### ■Setting method

Used to use a rotary encoder connected to the servo amplifier which supports the scale measurement mode as a synchronous encoder axis.

The following servo amplifiers can be used for the Motion module. Refer to the servo amplifier manual for the encoders that can be used with the scale measurement function.

- MR-J5-\_G
- MR-J5-\_G-RJ

A synchronous encoder connected to the specified servo amplifier axis can be used by the following settings.

Setting item	Setting method	Setting method of Motion Module Setting Function
Synchronous encoder axis setting	Set "101 to 108: Synchronous encoder via servo amplifier (Connectable servo amplifier: axis 1 to axis 8 <sup>*1</sup> )" in "[Pr.320] Synchronous encoder axis type".	Set the synchronous encoder axis parameter according to the setting below. <ul style="list-style-type: none"> <li>• [Pr.320] Type</li> <li>101: Synchronous encoder via servo amplifier</li> <li>• [Pr.320] Axis No. of connected servo amplifier</li> <li>Axis No. of servo amplifier to connect</li> </ul>
Encoder type setting (Absolute/Incremental)	To enable the scale measurement function with the MR-J5-_GN or MR-J5-_GN-RJ, set the servo parameter "Scale measurement function selection (PA22.3)" according to the setting below before connecting to the Motion module. <ul style="list-style-type: none"> <li>0: Disabled</li> <li>1: Used in absolute position detection system</li> <li>2: Used in incremental system</li> </ul> Refer to the servo amplifier manual for the parameter details and scale measurement encoder connection method.	—

\*1 The range from axis 1 to 4 is valid in the 4-axis module and from axis 1 to 8 is valid in the 8-axis module.

When "1: Used in absolute position detection system" is set in the servo parameter "Scale measurement function selection (PA22.3)", the synchronous encoder axis current value and the synchronous encoder axis current value per cycle are restored after the servo amplifier axis is connected. Therefore, connection becomes valid, and will be on the counter enabling status. When "2: Used in incremental system" is set in the servo parameter "Scale measurement function selection (PA22.3)", "0" is set to the initial value of the synchronous encoder axis current value and the synchronous encoder axis current value per cycle after the servo amplifier axis is connected. Therefore, connection becomes valid, and will be on the counter enabling status.

If the corresponding servo amplifier axis is not connected, the connection of the synchronous encoder axis will be invalid.

#### Point

When "1: Used in absolute position detection system" is set in the servo parameter "Scale measurement function selection (PA22.3)" and the synchronous encoder movement amount (encoder pulse units) on disconnection or during the power supply OFF exceeds "2147483647" or "-2147483648", the synchronous encoder axis current value is restored with its opposite sign.

## ■Point of the setting method

- When the servo parameter "Scale measurement function selection (PA22.3)" is changed, it is required to switch the power of servo amplifier off once after the parameter is transferred to the servo amplifier, and then switch it on again.
- If the servo amplifier set by the servo parameter "Scale measurement function selection (PA22.3)" does not support the "Scale measurement mode", "AL.37" (parameter error) will occur in the servo amplifier. Refer to the servo amplifier manual for details of the servo parameter "Scale measurement function selection (PA22.3)".
- The following information of the synchronous encoder via servo amplifier can be output with the optional data monitor. The setting details of the optional data monitor for the synchronous encoder information are shown below.

Information of synchronous encoder	Setting detail for optional data monitor
Scale position within one-revolution	24: Load side encoder information 1 (Used point: 2words)
Scale absolute counter	25: Load side encoder information 2 (Used point: 2words)

- A scale measurement encoder can be used in an incremental system by setting "2: Used in incremental system" in the servo parameter "Scale measurement function selection (PA22.3)" even when using a scale measurement encoder that supports the absolute position detection.

## ■Restrictions

- The scale measurement function can only be used when semi closed control mode is selected. Refer to the servo amplifier manual for details.
- When "1: Used in absolute position detection system" is set in the servo parameter "Scale measurement function selection (PA22.3)", "AL.25.2 (Scale measurement encoder - Absolute position erased)" occurs in the relevant servo amplifier after the encoder cable is connected and the power supply is turned ON for the first time.
- The error "Synchronous encoder via servo amplifier invalid error" (Error code: 1DFAH) occurs in the following cases.
  - When "[Pr.141] IP address" of an unset axis or a virtual servo amplifier axis is selected as the axis No. for "Synchronous encoder via servo amplifier" in "[Pr.320] Synchronous encoder axis type".
  - When a servo amplifier axis not having the servo parameter "Scale measurement function selection (PA22.3)" enabled is set as the connection servo amplifier axis No. in "Synchronous encoder via servo amplifier" and connected to the servo amplifier.
  - When the axis No. selected as the "Synchronous encoder via servo amplifier" in "[Pr.320] Synchronous encoder axis type" has a servo amplifier other than the MR-J5\_GN or MR-J5\_GN-RJ connected.
  - When a linear scale is connected.



## Synchronous encoder via CPU

### ■Setting method

Used to operate a gray code encoder that is connected to the input part of the CPU module or the extension input module as a synchronous encoder axis.

By setting "201: Synchronous encoder via CPU" in "[Pr.320] Synchronous encoder axis type", the synchronous encoder is controlled by the encoder value which is the input value of "[Cd.325] Input value for synchronous encoder via CPU".

The encoder value can be used as a cycle counter within the range from 0 to (Resolution of synchronous encoder via CPU - 1).

Connection is invalid just after the system's power supply is ON. When "1" is set in "[Cd.324] Connection command of synchronous encoder via CPU", the synchronous encoder axis current value and the synchronous encoder axis current value per cycle are restored based on "[Cd.325] Input value for synchronous encoder via CPU". Therefore, connection becomes valid, and will be on the counter enabling status.

The synchronous encoder axis is controlled based on the amount of change of "[Cd.325] Input value for synchronous encoder via CPU" while it is connecting.

### ■Setting example

The following shows an example for setting a synchronous encoder via CPU as synchronous encoder axis 4 of the Simple Motion module. (Resolution of the gray code encoder: 4096 pulses/rev)

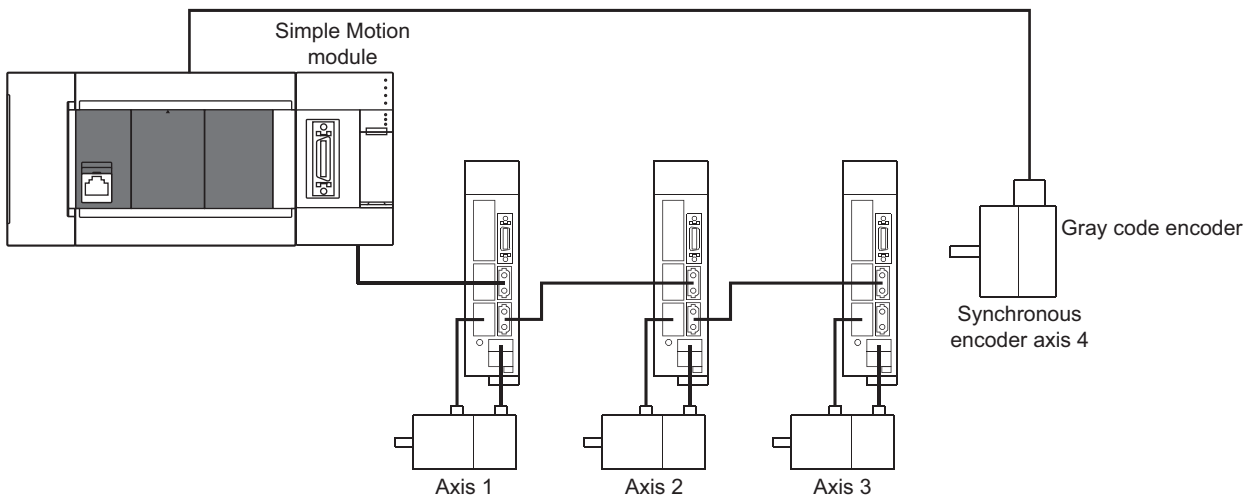

Set "201: Synchronous encoder via CPU" in "[Pr.320] Synchronous encoder axis type" of synchronous encoder axis 4.

Set "4096" in "[Pr.329] Resolution of synchronous encoder via CPU" of synchronous encoder axis 4.

Read the encoder value of the gray code encoder with a program, and update "[Cd.325] Input value for synchronous encoder via CPU" of the synchronous encoder axis 4 at every time.

### ■Restrictions

- "[Cd.325] Input value for synchronous encoder via CPU" is taken every operation cycle, but it is asynchronous with the scan time of the CPU module. Therefore, speed fluctuation of the synchronous encoder axis becomes larger if the refresh cycle of "[Cd.325] Input value for synchronous encoder via CPU" becomes long. Update "[Cd.325] Input value for synchronous encoder via CPU" in a cycle less than the operation cycle or use smooth speed fluctuation with the smoothing function.
- The synchronous encoder current value that is restored for the synchronous encoder connection gets restored into a converted value from the following range based on the synchronous encoder movement amount on disconnection.

Setting value of "[Pr.329] Resolution of synchronous encoder via CPU"	Range of restored synchronous encoder current value
1 or more	$-(\text{Resolution of synchronous encoder via CPU} / 2)$ to $(\text{Resolution of synchronous encoder via CPU} / 2 - 1)$ [pulse] <sup>*1</sup>
0 or less	-2147483648 to 2147483647 [pulse]

\*1 If the resolution of a synchronous encoder via CPU is an odd number, round down a negative value after the decimal point, round up a positive value after decimal point.

## Using an incremental synchronous encoder with FX5-SSC-G

When using an incremental synchronous encoder with the FX5-SSC-G, connect the encoder with the input part of the CPU module or the extension high-speed pulse input/output module, then import the incremental synchronous encoder data using the high-speed counter function of the CPU module.

For FX5-SSC-G, set "[Pr.320] Synchronous encoder axis type" to "201: Synchronous encoder via CPU".

For details of the high-speed counter function, refer to the following manual.

📖 MELSEC iQ-F FX5 User's Manual (Application)

For the wiring of the high-speed counter, refer to the following manuals.

📖 MELSEC iQ-F FX5U User's Manual (Hardware)

📖 MELSEC iQ-F FX5UC User's Manual (Hardware)

For the detailed settings of the synchronous encoder via CPU for FX5-SSC-G, refer to the following.

📖 Page 66 Synchronous encoder via CPU

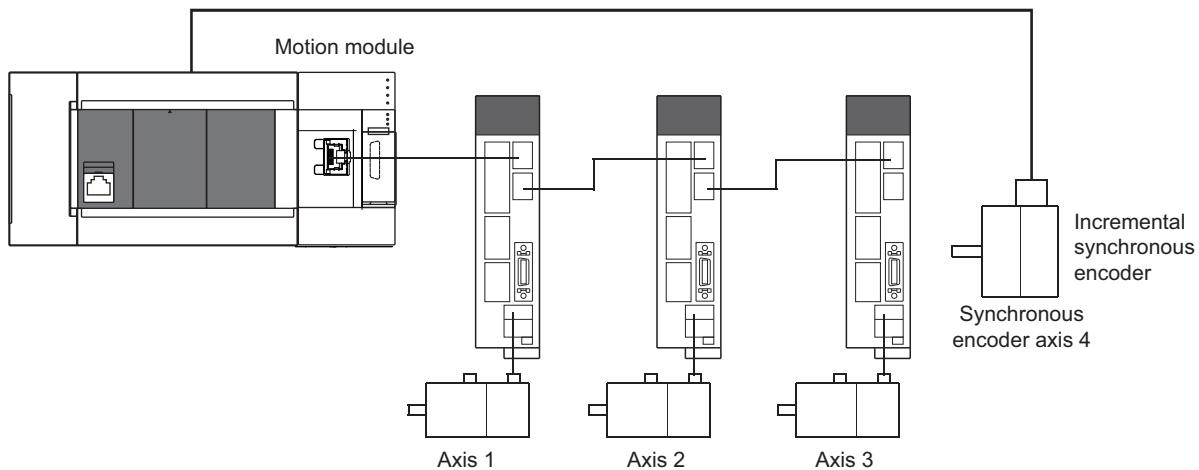

# Synchronous encoder axis parameters

j: Synchronous encoder axis No. - 1

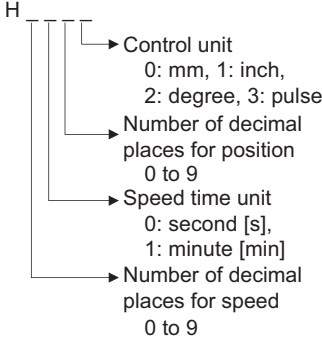
Setting item	Setting details	Setting value	Default value	Buffer memory address
[Pr.320] Synchronous encoder axis type	<ul style="list-style-type: none"> <li>Set the synchronous encoder axis type to be used.</li> </ul> <p>Fetch cycle: At power supply ON</p>	<p>■Set in decimal.</p> <p>0: Invalid 1: Incremental synchronous encoder [FX5-SSC-S] 101 to 108: Synchronous encoder via servo amplifier (Connectable servo amplifier: Axis 1 to axis 8<sup>1</sup>) 201: Synchronous encoder via CPU</p>	0	34720+20j
[Pr.321] Synchronous encoder axis unit setting	<ul style="list-style-type: none"> <li>Set the unit of the synchronous encoder axis.</li> <li>Set the position unit within the range from <math>\times 1</math> to <math>10^{-9}</math> [control unit].</li> <li>Set the speed unit within the range from <math>\times 1</math> to <math>10^{-9}</math> [control unit/s or control unit/min].</li> </ul> <p>Fetch cycle: At power supply ON</p>	<p>■Set in hexadecimal.</p> <p>H</p> 	0003H	34721+20j
[Pr.322] Synchronous encoder axis unit conversion: Numerator	<ul style="list-style-type: none"> <li>Set the numerator to convert the unit from the encoder pulse of the synchronous encoder axis into the synchronous encoder axis unit.</li> </ul> <p>Fetch cycle: At power supply ON</p>	<p>■Set in decimal.</p> <p>-2147483648 to 2147483647 [Synchronous encoder axis position units<sup>2</sup>]</p>	1	34722+20j 34723+20j
[Pr.323] Synchronous encoder axis unit conversion: Denominator	<ul style="list-style-type: none"> <li>Set the denominator to convert the unit from the encoder pulse of the synchronous encoder axis into the synchronous encoder axis unit.</li> </ul> <p>Fetch cycle: At power supply ON</p>	<p>■Set in decimal.</p> <p>1 to 2147483647 [pulse]</p>	1	34724+20j 34725+20j
[Pr.324] Synchronous encoder axis length per cycle	<ul style="list-style-type: none"> <li>Set the length per cycle of the synchronous encoder axis.</li> </ul> <p>Fetch cycle: At power supply ON</p>	<p>■Set in decimal.</p> <p>1 to 2147483647 [Synchronous encoder axis position units<sup>2</sup>]</p>	4000	34726+20j 34727+20j
[Pr.325] Synchronous encoder axis smoothing time constant	<ul style="list-style-type: none"> <li>Set the time to smooth for the input value.</li> </ul> <p>Fetch cycle: At power supply ON</p>	<p>■Set in decimal.</p> <p>0 to 5000 [ms]</p>	0	34728+20j
[Pr.326] Synchronous encoder axis phase compensation advance time	<ul style="list-style-type: none"> <li>Set the time to advance or delay the phase.</li> </ul> <p>Fetch cycle: Operation cycle</p>	<p>■Set in decimal.</p> <p>-2147483648 to 2147483647 [<math>\mu</math>s]</p>	0	34730+20j 34731+20j
[Pr.327] Synchronous encoder axis phase compensation time constant	<ul style="list-style-type: none"> <li>Set the time constant to affect the phase compensation.</li> </ul> <p>Fetch cycle: At power supply ON</p>	<p>■Set in decimal.</p> <p>0 to 65535 [ms]<sup>13</sup></p>	10	34732+20j
[Pr.328] Synchronous encoder axis rotation direction restriction	<ul style="list-style-type: none"> <li>Set this parameter to restrict the input movement amount to one direction.</li> </ul> <p>Fetch cycle: At power supply ON</p>	<p>■Set in decimal.</p> <p>0: Without rotation direction restriction 1: Enable only for current value increase direction 2: Enable only for current value decrease direction</p>	0	34733+20j

Setting item	Setting details	Setting value	Default value	Buffer memory address
[Pr.329] Resolution of synchronous encoder via CPU	<ul style="list-style-type: none"> <li>Set the resolution of the synchronous encoder when the synchronous encoder axis type is set to synchronous encoder via CPU.</li> <li>If 0 or less is set, the input value of synchronous encoder via CPU is processed as 32-bit counter.</li> </ul> Fetch cycle: At power supply ON	■Set in decimal. -2147483648 to 2147483647 [pulse]	0	34734+20j 34735+20j

- \*1 The range from axis 1 to 4 is valid in the 4-axis module and from axis 1 to 8 is valid in the 8-axis module.
- \*2 Synchronous encoder axis position units (  Page 58 Synchronous encoder axis position units)
- \*3 Set the value as follows in a program.  
 0 to 32767: Set as a decimal  
 32768 to 65535: Convert into a hexadecimal and set

## [Pr.320] Synchronous encoder axis type

Set the synchronous encoder type to be generated of the input value for the synchronous encoder axis.

Setting value	Details
0: Invalid	Synchronous encoder axis is invalid.
1: Incremental synchronous encoder [FX5-SSC-S]	Generate the input value based on the incremental synchronous encoder input.
101 to 108: Synchronous encoder via servo amplifier (Connectable servo amplifier: Axis 1 to axis 8*1)	Generate the input value based on the synchronous encoder input via servo amplifier connected to the specified servo amplifier (axis 1 to axis 8).
201: Synchronous encoder via CPU	Generate the input value with the value set in the buffer memory by the CPU module as the encoder value.

\*1 The range from axis 1 to 4 is valid in the 4-axis module and from axis 1 to 8 is valid in the 8-axis module.

## [Pr.321] Synchronous encoder axis unit setting

Set the position and speed unit of the synchronous encoder axis. Refer to the following for details.

☞ Page 58 Units for the synchronous encoder axis

## [Pr.322] Synchronous encoder axis unit conversion: Numerator

The input movement amount of synchronous encoder is configured in encoder pulse units.

The units can be arbitrarily converted through unit conversation with setting "[Pr.322] Synchronous encoder axis unit conversion: Numerator" and "[Pr.323] Synchronous encoder axis unit conversion: Denominator".

Set "[Pr.322] Synchronous encoder axis unit conversion: Numerator" and "[Pr.323] Synchronous encoder axis unit conversion: Denominator" according to the controlled machine.

$$\text{Synchronous encoder axis movement amount (Movement amount after unit conversion)} = \frac{\text{Synchronous encoder input movement amount (Encoder pulse units)} \times [\text{Pr.322} \text{ Synchronous encoder axis unit conversion: Numerator}]}{[\text{Pr.323} \text{ Synchronous encoder axis unit conversion: Denominator}]}$$

The movement amount corresponding to "[Pr.323] Synchronous encoder axis unit conversion: Denominator" is set in "[Pr.322] Synchronous encoder axis unit conversion: Numerator" in synchronous encoder axis position units (☞ Page 58 Synchronous encoder axis position units). The input movement amount can be reversed by the setting negative values. Set "[Pr.323] Synchronous encoder axis unit conversion: Denominator" based on encoder pulse units from the synchronous encoder. Set a value within the range from 1 to 2147483647.

## [Pr.323] Synchronous encoder axis unit conversion: Denominator

The input movement amount of synchronous encoder is configured in encoder pulse units.

The units can be arbitrarily converted through unit conversation with setting "[Pr.322] Synchronous encoder axis unit conversion: Numerator" and "[Pr.323] Synchronous encoder axis unit conversion: Denominator".

Set "[Pr.322] Synchronous encoder axis unit conversion: Numerator" and "[Pr.323] Synchronous encoder axis unit conversion: Denominator" according to the controlled machine.

$$\text{Synchronous encoder axis movement amount (Movement amount after unit conversion)} = \frac{\text{Synchronous encoder input movement amount (Encoder pulse units)} \times [\text{Pr.322} \text{ Synchronous encoder axis unit conversion: Numerator}]}{[\text{Pr.323} \text{ Synchronous encoder axis unit conversion: Denominator}]}$$

The movement amount corresponding to "[Pr.323] Synchronous encoder axis unit conversion: Denominator" is set in "[Pr.322] Synchronous encoder axis unit conversion: Numerator" in synchronous encoder axis position units (☞ Page 58 Synchronous encoder axis position units). The input movement amount can be reversed by the setting negative values. Set "[Pr.323] Synchronous encoder axis unit conversion: Denominator" based on encoder pulse units from the synchronous encoder. Set a value within the range from 1 to 2147483647.

## [Pr.324] Synchronous encoder axis length per cycle

Set the length per cycle for the synchronous encoder axis current value per cycle.

The current value of synchronous encoder axis is stored in "[Md.321] Synchronous encoder axis current value per cycle" at ring counter based on the setting value.

The unit settings are in synchronous encoder axis position units (☞ Page 58 Synchronous encoder axis position units). Set a value within the range from 1 to 2147483647.



**Setting example of the unit conversion and the length per cycle.**

The following shows an example a rotary encoder is connected which resolution is 4000 [pulse/rev] to the motor axis side on the rotation table that drives by 1/5 pulley system, and the control unit is degree.

- Position unit: 0.1 [degree]
- Speed unit: 0.001 [degree/min]
- Length per cycle: 360.0 [degree] (1 cycle of the rotation table)

Setting item	Setting details	Setting value	
[Pr.321] Synchronous encoder axis unit setting	Control unit	2: degree	3112H
	Number of decimal places for position	1	
	Speed time unit	1: minute [min]	
	Number of decimal places for speed	3	
[Pr.322] Synchronous encoder axis unit conversion: Numerator	360.0 [degree] × 1	3600 [×0.1 degree]	
[Pr.323] Synchronous encoder axis unit conversion: Denominator	4000 [pulse] × 5	20000 [pulse]	
[Pr.324] Synchronous encoder axis length per cycle	360.0 [degree]	3600 [×0.1 degree]	

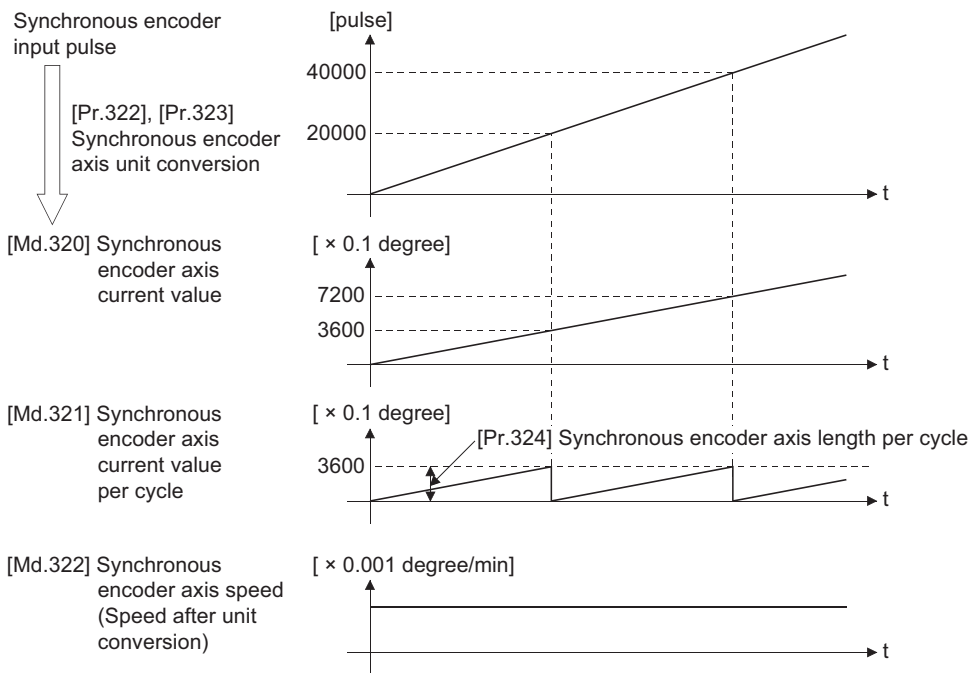

**[Pr.325] Synchronous encoder axis smoothing time constant**

Set the averaging time to execute a smoothing process for the input movement amount from synchronous encoder.

The smoothing process can moderate speed fluctuation of the synchronous encoder input.

The input response is delayed depending on the time corresponding to the setting by smoothing process setting.

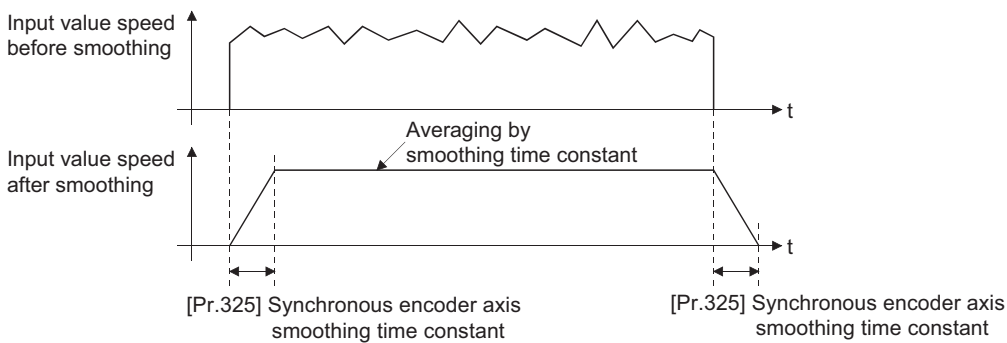

## [Pr.326] Synchronous encoder axis phase compensation advance time

Set the time to advance or delay the phase (input response) of the synchronous encoder axis.

Refer to the following for the delay time inherent to the system using the synchronous encoder axis.

☞ Page 139 Phase Compensation Function

Setting value	Details
1 to 2147483647 [ $\mu$ s]	Advance the phase (input response) according to the setting time.
0 [ $\mu$ s]	Do not execute phase compensation.
-2147483648 to -1 [ $\mu$ s]	Delay the phase (input response) according to the setting time.

If the setting time is too long, the system experiences overshoot or undershoot at acceleration/deceleration of the input speed. In this case, set a longer time to affect the phase compensation amount in "[Pr.327] Synchronous encoder axis phase compensation time constant".

## [Pr.327] Synchronous encoder axis phase compensation time constant

Set the time constant to affect the phase compensation amount for the first order delay.

63 [%] of the phase compensation amount are reflected in the time constant setting.

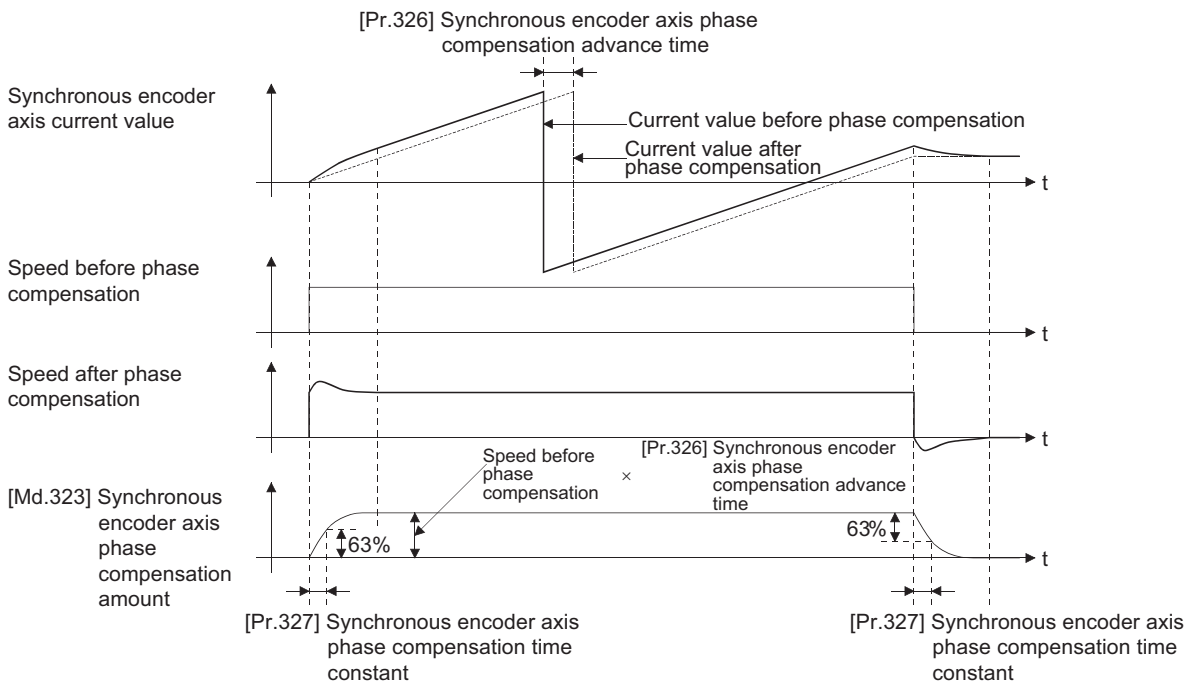

## [Pr.328] Synchronous encoder axis rotation direction restriction

Set this parameter to restrict the input movement amount for the synchronous encoder axis to one direction. This helps to avoid reverse operation caused by such as machine vibration of the synchronous encoder input.

Setting value	Details
0: Without rotation direction restriction	Rotation direction restriction is not executed.
1: Enable only for current value increase direction	Enable only the input movement amount in the increasing direction of the synchronous encoder axis current value.
2: Enable only for current value decrease direction	Enable only the input movement amount in the decreasing direction of the synchronous encoder axis current value.

The input movement amount in the reverse direction of the enabled direction accumulates as a rotation direction restricted amount, and it will be reflected when the input movement amount moves in the enabled direction again. Therefore, the current value of synchronous encoder axis does not deviate when the reverse operation is repeated.

The rotation direction restricted amount is set to 0 at the synchronous encoder axis connection and current value change.

For "1: Enable only for current value increase direction" is set in "[Pr.328] Synchronous encoder axis rotation direction restriction".

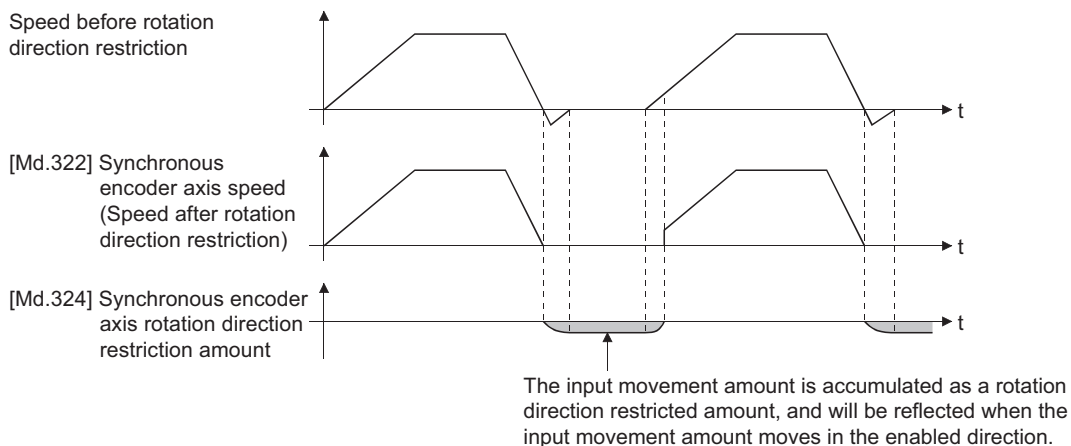

## [Pr.329] Resolution of synchronous encoder via CPU

Set the resolution of connected synchronous encoder when "201: Synchronous encoder via CPU" is set in "[Pr.320] Synchronous encoder axis type".

If 1 or more is set, "[Cd.325] Input value for synchronous encoder via CPU" is processed as the cycle counter within the range from 0 to (resolution of synchronous encoder via CPU - 1).

If 0 or less is set, "[Cd.325] Input value for synchronous encoder via CPU" is processed as 32 bit counter within the range from -2147483648 to 2147483647.

### Point

If 1 or more is set in "[Pr.329] Resolution of synchronous encoder via CPU", set the cycle counter from 0 to (resolution of synchronous encoder via CPU - 1) in "[Cd.325] Input value for synchronous encoder via CPU" as the input value.

# Synchronous encoder axis control data

j: Synchronous encoder axis No. - 1

Setting item	Setting details	Setting value	Default value	Buffer memory address
[Cd.320] Synchronous encoder axis control start	<ul style="list-style-type: none"> <li>If set to "1", the synchronous encoder axis control is started.</li> <li>If set to "101 to 108", the synchronous encoder axis control starts based on the highspeed input request (external command signal).</li> <li>The Simple Motion module/Motion module resets the value to "0" automatically after completion of the synchronous encoder axis control.</li> </ul> Fetch cycle: <u>Operation cycle</u>	■Set in decimal. 1: Start for synchronous encoder axis control 101 to 108: High-speed input start for synchronous encoder axis control (axis 1 to axis 8 <sup>*1</sup> )	0	35040+10j
[Cd.321] Synchronous encoder axis control method	<ul style="list-style-type: none"> <li>Set the control method for the synchronous encoder axis.</li> </ul> Fetch cycle: <u>At synchronous encoder axis control start</u>	■Set in decimal. 0: Current value change 1: Counter disable 2: Counter enable	0	35041+10j
[Cd.322] Synchronous encoder axis current value setting address	<ul style="list-style-type: none"> <li>Set a new current value for changing the current value.</li> </ul> Fetch cycle: <u>At synchronous encoder axis control start</u>	■Set in decimal. -2147483648 to 2147483647 [Synchronous encoder axis position units <sup>*3</sup> ]	0	35042+10j 35043+10j
[Cd.323] Synchronous encoder axis error reset	<ul style="list-style-type: none"> <li>If set to "1" for resetting error and warning for the synchronous encoder axis, the error No. and warning No. are set to 0, and the error detection and warning detection bits status are turned OFF.</li> <li>The Simple Motion module/Motion module resets the value to "0" automatically after completion of the error reset.</li> <li>In the case of the synchronous encoder axis parameter error, even if the error is reset, the setting valid flag of the synchronous encoder axis status has been OFF.</li> </ul> Fetch cycle: <u>Main cycle</u> <sup>*2</sup>	■Set in decimal. 1: Error reset request	0	35044+10j
[Cd.324] Connection command of synchronous encoder via CPU	<ul style="list-style-type: none"> <li>If set to "1", the synchronous encoder via CPU is connected.</li> <li>If set to "0", the synchronous encoder via CPU is disconnected.</li> </ul> Fetch cycle: <u>Main cycle</u> <sup>*2</sup>	■Set in decimal. 1: Connect synchronous encoder via CPU 0: Disconnect synchronous encoder via CPU	0	35045+10j
[Cd.325] Input value for synchronous encoder via CPU	<ul style="list-style-type: none"> <li>Set a value to be used every time as the input value for the synchronous encoder for the synchronous encoder via CPU.</li> </ul> Fetch cycle: <u>Operation cycle</u>	■Set in decimal. -2147483648 to 2147483647 [pulse]	0	35046+10j 35047+10j

\*1 The range from axis 1 to 4 is valid in the 4-axis module and from axis 1 to 8 is valid in the 8-axis module.

\*2 With the exception of positioning control, main cycle processing is executed during the next available time. It changes by status of axis start.

\*3 Synchronous encoder axis position units (  Page 58 Synchronous encoder axis position units)

## [Cd.320] Synchronous encoder axis control start

If set to "1", the synchronous encoder axis control is started.

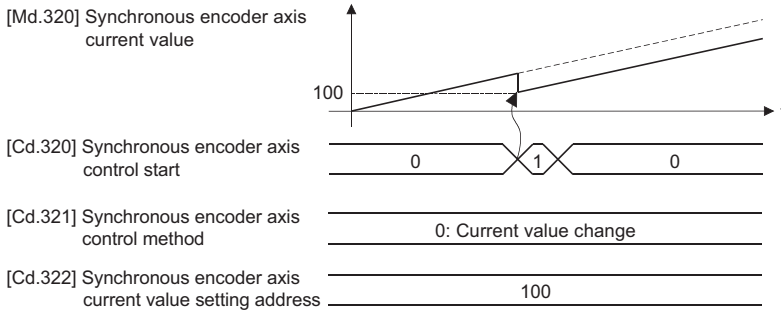

If set to "101 to 108", the synchronous encoder axis control starts based on the high-speed input request [DI] for the specified servo amplifier axis.

Set "4: High speed input request" in "[Pr.42] External command function selection" and set "1: Validates an external command" in "[Cd.8] External command valid" for the specified servo amplifier axis to start from a high speed input request [DI]. Also, set the external command signal to be used in "[Pr.95] External command signal selection".

Set the control method for the synchronous encoder axis in "[Cd.321] Synchronous encoder axis control method".

The Simple Motion module/Motion module resets the value to "0" automatically after completion of the synchronous encoder axis control.

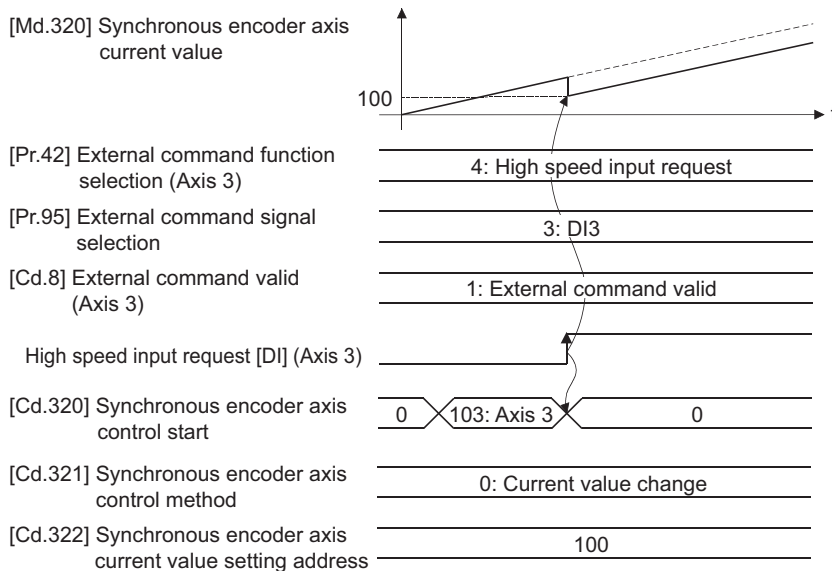

## [Cd.321] Synchronous encoder axis control method

Set the control method for the synchronous encoder axis.

Setting value	Details
0: Current value change	The synchronous encoder axis current value and the synchronous encoder axis current value per cycle are changed as follows. Set the new current value in "[Cd.322] Synchronous encoder axis current value setting address".
[Md.320] Synchronous encoder axis current value	"[Cd.322] Synchronous encoder axis current value setting address"
[Md.321] Synchronous encoder axis current value per cycle	A value that is converted "[Cd.322] Synchronous encoder axis current value setting address" into the range from 0 to "[Pr.324] Synchronous encoder axis length per cycle - 1".
1: Counter disable	Input from the synchronous encoder is invalid. Smoothing processing, phase compensation processing and rotation direction restriction processing are continued. While these processes are valid, the input axis speed may not stop immediately when the counter disable is selected.
2: Counter enable	Input from the synchronous encoder is valid.

### **[Cd.322] Synchronous encoder axis current value setting address**

Set a new current value in synchronous encoder axis position units to apply to the current value change for the synchronous encoder axis (  Page 58 Synchronous encoder axis position units).

### **[Cd.323] Synchronous encoder axis error reset**

If set to "1", "[Md.326] Synchronous encoder axis error No." and "[Md.327] Synchronous encoder axis warning No." are set to 0 and then "b4: Error detection flag" and "b5: Warning detection flag" of "[Md.325] Synchronous encoder axis status" are turned OFF. A synchronous encoder connection becomes valid if there is no error.

The Simple Motion module resets the value to "0" automatically after completion of the error reset.

However, the setting of the synchronous encoder axis will not be valid even if the error is reset for the setting error of the synchronous encoder axis parameter. Reconfigure the parameter and turn the power supply ON again.

### **[Cd.324] Connection command of synchronous encoder via CPU**

Use this data when "201: Synchronous encoder via CPU" is set in "[Pr.320] Synchronous encoder axis type".

If set to "1", the synchronous encoder axis is connected. Once connected, the synchronous encoder current value is restored based on the "[Cd.325] Input value for synchronous encoder via CPU".

If set to "0", the synchronous encoder axis is disconnected.

### **[Cd.325] Input value for synchronous encoder via CPU**

Use this data when "201: Synchronous encoder via CPU" is set in "[Pr.320] Synchronous encoder axis type".

Set a value to be used every time as the input value for the synchronous encoder in encoder pulse units.

If 1 or more is set in "[Pr.329] Resolution of synchronous encoder via CPU", it is processed as a cycle counter within the range from 0 to (resolution of synchronous encoder via CPU - 1).

# Synchronous encoder axis monitor data

j: Synchronous encoder axis No. - 1

Monitor item	Storage details	Monitor value	Buffer memory address																																
[Md.320] Synchronous encoder axis current value	<ul style="list-style-type: none"> <li>The current value for the synchronous encoder axis is stored.</li> </ul> <u>Refresh cycle: Operation cycle</u>	<ul style="list-style-type: none"> <li>Monitoring is carried out in decimal.</li> <li>-2147483648 to 2147483647</li> <li>[Synchronous encoder axis position units*<sup>1</sup>]</li> </ul>	35200+20j 35201+20j																																
[Md.321] Synchronous encoder axis current value per cycle	<ul style="list-style-type: none"> <li>The current value per cycle for a synchronous encoder axis is stored.</li> </ul> <u>Refresh cycle: Operation cycle</u>	<ul style="list-style-type: none"> <li>Monitoring is carried out in decimal.</li> <li>0 to (Synchronous encoder axis length per cycle - 1)</li> <li>[Synchronous encoder axis position units*<sup>1</sup>]</li> </ul>	35202+20j 35203+20j																																
[Md.322] Synchronous encoder axis speed	<ul style="list-style-type: none"> <li>The speed for a synchronous encoder axis is stored.</li> </ul> <u>Refresh cycle: Operation cycle</u>	<ul style="list-style-type: none"> <li>Monitoring is carried out in decimal.</li> <li>-2147483648 to 2147483647</li> <li>[Synchronous encoder axis speed units*<sup>2</sup>]</li> </ul>	35204+20j 35205+20j																																
[Md.323] Synchronous encoder axis phase compensation amount	<ul style="list-style-type: none"> <li>The phase compensation amount is stored.</li> </ul> <u>Refresh cycle: Operation cycle</u>	<ul style="list-style-type: none"> <li>Monitoring is carried out in decimal.</li> <li>-2147483648 to 2147483647</li> <li>[Synchronous encoder axis position units*<sup>1</sup>]</li> </ul>	35206+20j 35207+20j																																
[Md.324] Synchronous encoder axis rotation direction restriction amount	<ul style="list-style-type: none"> <li>While the rotation direction is restricted, the accumulation for the input movement amount in the opposite direction of the enabled direction is stored.</li> </ul> <u>Refresh cycle: Operation cycle</u>	<ul style="list-style-type: none"> <li>Monitoring is carried out in decimal.</li> <li>-2147483648 to 2147483647</li> <li>[Synchronous encoder axis position units*<sup>1</sup>]</li> </ul>	35208+20j 35209+20j																																
[Md.325] Synchronous encoder axis status	<ul style="list-style-type: none"> <li>The status for a synchronous encoder axis is monitored.</li> </ul> <u>Refresh cycle: Operation cycle</u>	<ul style="list-style-type: none"> <li>Monitoring is carried out in hexadecimal.</li> </ul> <div style="text-align: center;"> <p>Buffer memory</p> <table border="1" style="margin: auto;"> <tr> <td>b15</td><td>b12</td><td>b8</td><td>b4</td><td>b0</td></tr> <tr> <td style="width: 20px; height: 15px;"></td><td style="width: 20px; height: 15px;"></td><td style="width: 20px; height: 15px;"></td><td style="width: 20px; height: 15px;"></td><td style="width: 20px; height: 15px;"></td></tr> <tr> <td colspan="5" style="text-align: center;">Not used</td></tr> </table> <table border="1" style="margin: auto;"> <thead> <tr> <th colspan="2">Stored items</th> <th>Meaning</th> </tr> </thead> <tbody> <tr> <td>b0</td> <td>Setting valid flag</td> <td rowspan="5" style="text-align: center; vertical-align: middle;">0: OFF 1: ON</td> </tr> <tr> <td>b1</td> <td>Connecting valid flag</td> </tr> <tr> <td>b2</td> <td>Counter enable flag</td> </tr> <tr> <td>b3</td> <td>Current value setting request flag</td> </tr> <tr> <td>b4</td> <td>Error detection flag</td> </tr> <tr> <td>b5</td> <td>Warning detection flag</td> <td></td> </tr> </tbody> </table> </div>	b15	b12	b8	b4	b0						Not used					Stored items		Meaning	b0	Setting valid flag	0: OFF 1: ON	b1	Connecting valid flag	b2	Counter enable flag	b3	Current value setting request flag	b4	Error detection flag	b5	Warning detection flag		35210+20j
b15	b12	b8	b4	b0																															
Not used																																			
Stored items		Meaning																																	
b0	Setting valid flag	0: OFF 1: ON																																	
b1	Connecting valid flag																																		
b2	Counter enable flag																																		
b3	Current value setting request flag																																		
b4	Error detection flag																																		
b5	Warning detection flag																																		
[Md.326] Synchronous encoder axis error No.	<ul style="list-style-type: none"> <li>The error code for the synchronous encoder axis is stored.</li> </ul> <u>Refresh cycle: Operation cycle</u>	<ul style="list-style-type: none"> <li>Monitoring is carried out in hexadecimal.</li> <li>( MELSEC iQ-F FX5 Motion Module/Simple Motion Module User's Manual (Application))</li> </ul>	35211+20j																																
[Md.327] Synchronous encoder axis warning No.	<ul style="list-style-type: none"> <li>The warning code for the synchronous encoder axis is stored.</li> </ul> <u>Refresh cycle: Operation cycle</u>	<ul style="list-style-type: none"> <li>Monitoring is carried out in hexadecimal.</li> <li>( MELSEC iQ-F FX5 Motion Module/Simple Motion Module User's Manual (Application))</li> </ul>	35212+20j																																

\*1 Synchronous encoder axis position units ( Page 58 Synchronous encoder axis position units)

\*2 Synchronous encoder axis speed units ( Page 58 Synchronous encoder axis speed units)

## [Md.320] Synchronous encoder axis current value

The current value for the synchronous encoder axis is stored in synchronous encoder axis position units ( Page 58 Synchronous encoder axis position units).

The synchronous encoder position for an incremental synchronous encoder is "0" immediately after the power supply ON.

## [Md.321] Synchronous encoder axis current value per cycle

The current value per cycle for a synchronous encoder axis is stored in the range from 0 to ("[Pr.324] Synchronous encoder axis length per cycle" - 1).

The unit is synchronous encoder axis position units ( Page 58 Synchronous encoder axis position units).

## [Md.322] Synchronous encoder axis speed

The speed for a synchronous encoder axis is stored in synchronous encoder axis speed units (  Page 58 Synchronous encoder axis speed units).

If the speed for a synchronous encoder axis exceeds the monitor range (  Page 55 Overview of synchronous encoder axis), the warning "Input axis speed display over" (warning code: 0BD2H [FX5-SSC-S], or warning code: 0E42H [FX5-SSC-G]) will occur. In this case, use a smaller number of decimal places for the speed in "[Pr.321] Synchronous encoder axis unit setting" or set the speed time units to "0: second [s]".

## [Md.323] Synchronous encoder axis phase compensation amount

The phase compensation amount for a synchronous encoder axis is stored in the synchronous encoder axis position units (  Page 58 Synchronous encoder axis position units).

The phase compensation amount for a synchronous encoder axis is the value after smoothing processing and phase compensation processing.

## [Md.324] Synchronous encoder axis rotation direction restriction amount

While the rotation direction is restricted for a synchronous encoder axis, the accumulation for input movement amount in the opposite direction of the enabled direction is stored in synchronous encoder axis position units (  Page 58 Synchronous encoder axis position units) as follows.

Setting value of "[Pr.328] Synchronous encoder axis rotation direction restriction"	Storage details
1: Enable only for current value increase direction	A negative accumulation is stored during rotation direction restriction. 0 is stored if there is no restriction.
2: Enable only for current value decrease direction	A positive accumulation is stored during rotation direction restriction. 0 is stored if there is no restriction.

Rotation direction restriction is processed after phase compensation processing. Therefore, if undershoot occurs from phase compensation during deceleration stop, the rotation direction restriction amount might remain.

## [Md.325] Synchronous encoder axis status

The each status for a synchronous encoder axis is monitored with the following each bits.

Bit	Storage item	Storage details
b0	Setting valid flag	At power supply ON, this flag turns ON when the synchronous encoder axis parameter ([Pr.320] to [Pr.329]) is normal and the setting of the synchronous encoder axis is valid. It is turned OFF when the setting is invalid or an error occurs.
b1	Connecting valid flag	When the synchronous encoder axis setting is valid, the synchronous encoder connection also becomes valid and this flag turns ON. This flag turns OFF when the connection is invalid. When setting an incremental synchronous encoder, this flag turns ON simultaneously the power supply turns ON regardless of connecting the current encoder.
b2	Counter enable flag	This flag turns ON when input from the synchronous encoder is enabled. If the counter disable control <sup>*1</sup> is executed, it is turned OFF, and input from the synchronous encoder becomes invalid. If the counter enable control <sup>*1</sup> is executed, it is turned ON, and input from the synchronous encoder becomes valid. When the synchronous encoder is valid to connect, the initial status is ON (enable) status.
b3	Current value setting request flag	This flag turns ON, when a synchronous encoder axis current value change is never executed. If the current value setting request flag is ON for the synchronous encoder connection, the synchronous encoder axis current value starts counting with 0. This flag turns OFF when a synchronous encoder axis current value change is executed.
b4	Error detection flag	This flag turns ON when an error occurs for the synchronous encoder axis. The error No. is stored in "[Md.326] Synchronous encoder axis error No." Reset the error in "[Cd.323] Synchronous encoder axis error reset".
b5	Warning detection flag	This flag turns ON when a warning occurs for the synchronous encoder axis. The warning No. is stored in "[Md.327] Synchronous encoder axis warning No." Reset the warning in "[Cd.323] Synchronous encoder axis error reset".
b6 to b15	Not used	Always OFF

\*1 Set the control method for synchronous encoder in "[Cd.321] Synchronous encoder axis control method". (  Page 74 Synchronous encoder axis control data)



### **[Md.326] Synchronous encoder axis error No.**

When an error for a synchronous encoder axis is detected, the error code corresponding to the error details is stored.  
If set to "1" in "[Cd.323]Synchronous encoder axis error reset", the value is set to "0".

### **[Md.327] Synchronous encoder axis warning No.**

When a warning for a synchronous encoder axis is detected, the warning code corresponding to the warning details is stored.  
If set to "1" in "[Cd.323] Synchronous encoder axis error reset", the value is set to "0".

# 3 CAM FUNCTION

The details on cam data and operation for cam function in output axis (cam axis) are explained in this chapter.

The cam function controls output axis by creating cam data that corresponds to the operation.

The functions to operate cam data include "Cam data operation function", "Cam auto-generation function", and "Cam position calculation function".

Refer to the following for the setting of the output axis.

☞ Page 96 ADVANCED SYNCHRONOUS CONTROL

Refer to the following for the cam position calculation function.

☞ Page 161 Cam Position Calculation Function

## 3.1 Control Details for Cam Function

The output axis for synchronous control is operated with a cam.

The following operations can be performed with cam functions.

- Two-way operation: Reciprocating operation with a constant cam strokes range.
- Feed operation: Cam reference position is updated every cycle.
- Linear operation: Linear operation (cam No.0) in the cycle as the stroke ratio is 100%.

The output axis is controlled by a value (feed current value), which is converted from the input value (cam axis current value per cycle) by cam data.

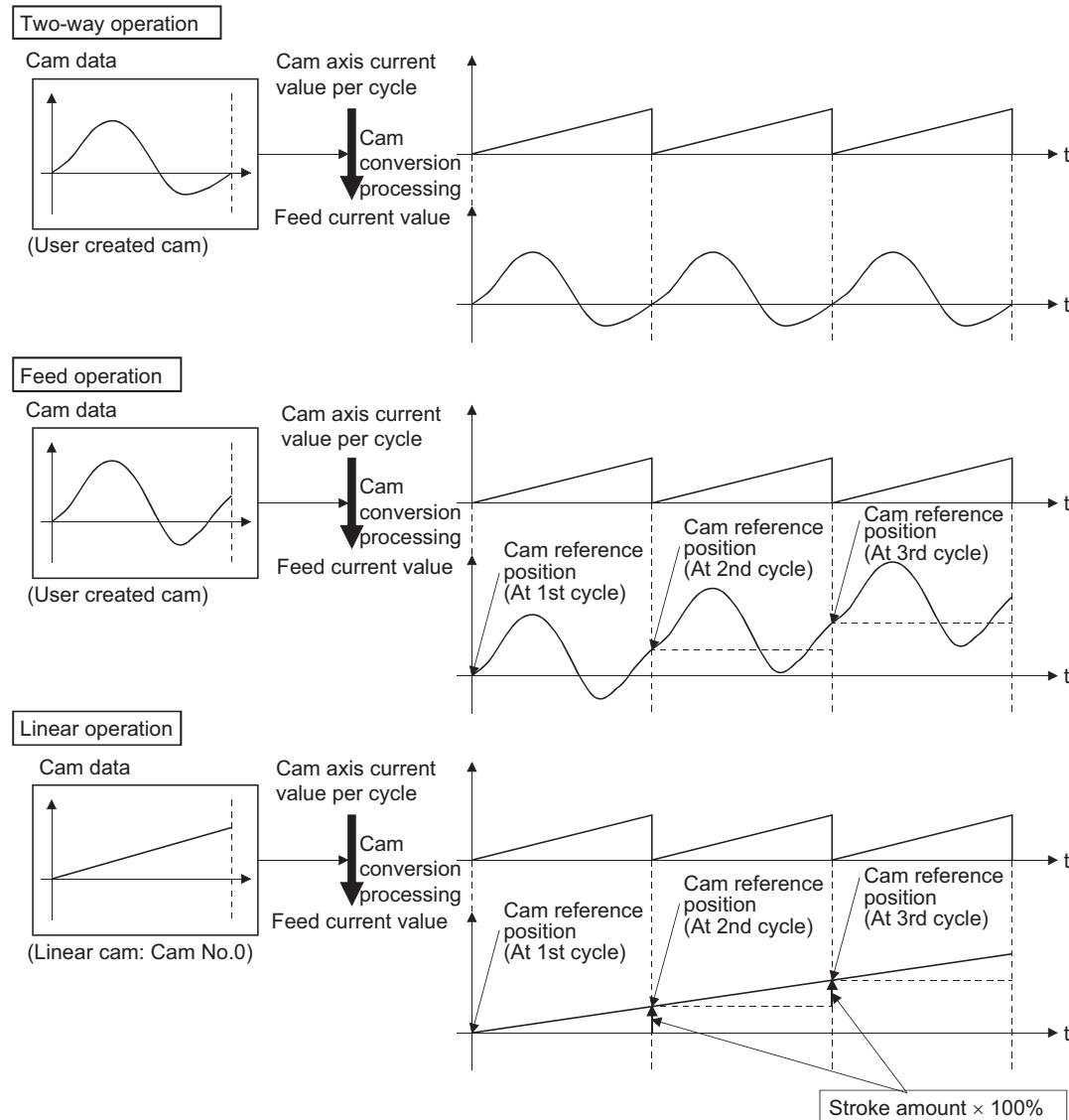

## Cam data

The cam data used in the cam function includes "storage data" which is used for reading/writing with EM Configurator and "open data" which is transmitted to the internal memory at cam control.

Storage data	Open data
— (Reading and writing not possible)	Linear cam
Stroke ratio data format	Stroke ratio data format
Auto-generation data format	Coordinate data format
Cam for rotary cutter	
Coordinate data format	

Storage data and open data are same for cams using the stroke ratio data format and the coordinate data format. A cam using the auto-generation data format (storage data) operates after being changed (transmitted) to the stroke ratio data format.

- Data read/written with the engineering tool

To re-edit the cam data read from the Simple Motion module/Motion module with the engineering tool, read/write both of "cam data (edit data)" and "cam data (converted data)" when reading/writing the cam data. If only "cam data (conversion data)" is read/written, re-edition may not be executed or the information such as units and strokes may be missed.

### ■Linear cam control

When "0" is set for "[Pr.440] Cam No.", the cam data operates as a straight line with a 100% stroke ratio at the last point.

The linear cam does not consume the cam open area. Also, it cannot be read/written as storage data.

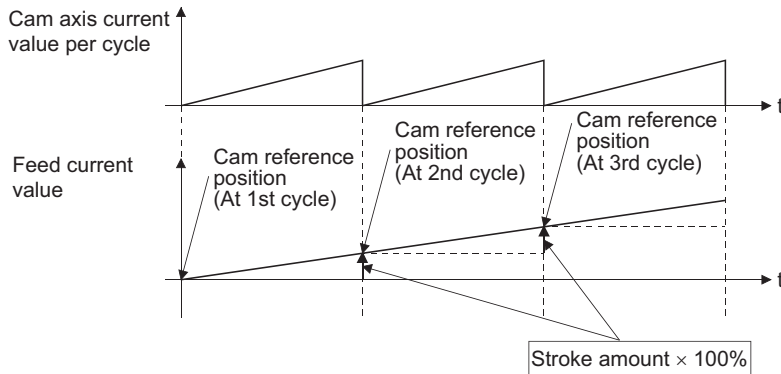

## ■Stroke ratio data format

The stroke ratio data format is defined in equal divisions for one cam cycle based on the cam resolution, and configured with stroke ratio data from points within the cam resolution.

Refer to the following for setting methods for cam data.

☞ Page 87 Create Cam Data

Setting item	Setting details	Setting range	Default value (Engineering tool)	Cam data operation function
Cam No.	Set the cam No.	0: Linear cam 1 to 64: User created cam for 4-axis module (Cam storage area) 1 to 128: User created cam for 8-axis module (Cam storage area) 1 to 256: User created cam for 4-/8- axis module (Cam open area)	1	[Cd.601] Operation cam No.
Cam data format	Set "1". (Setting with the engineering tool is not required.)	1: Stroke ratio data format	1	[Cd.604] Cam data format
Cam resolution	Set the number of divisions for one cam cycle.	256/512/1024/2048/4096/8192/16384	256	[Cd.605] Cam resolution/ coordinate number
Cam data starting point	Set the cam data point corresponding to "Cam axis current value per cycle = 0".	0 to (Cam resolution - 1)	0	[Cd.606] Cam data starting point
Stroke ratio data	Set the stroke ratio from the 1st to the last point. (The 0th point setting is not required. It is always 0%.)	-2147483648 to 2147483647 [ $\times 10^{-7}$ ]*1 (-214.7483648 to 214.7483647%)	0	[Cd.607] Cam data value

\*1 To display the stroke ratio out of range  $\pm 100\%$ , select the "Simple Motion" of "Intelligent Function Module" and set "Yes" to the "Display Extended Stroke of Cam Graph" on the "Options" window displayed by the menu bar of the engineering tool [Tool] ⇒ [Options].

**Ex.**

Cam resolution: 512

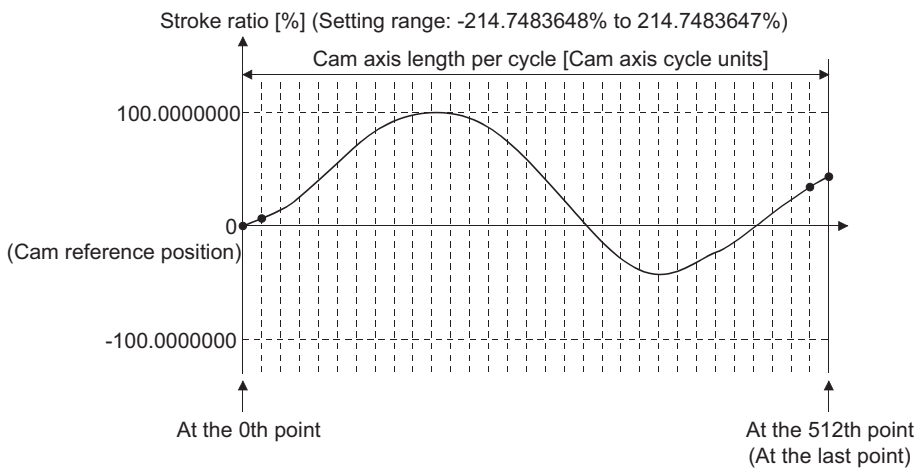

## Coordinate data format

The coordinate data format is defined in coordinates of more than 2 points for one cam cycle. The coordinate data is represented as "(Input value, Output value)".

Input value: Cam axis current value per cycle

Output value: Stroke position from cam reference position

With this format, "[Pr.441] Cam stroke amount" of output axis parameter is ignored and output value of the coordinate data becomes cam stroke position.

Refer to the following for setting methods for cam data.

Page 87 Create Cam Data

Setting item	Setting details	Setting range	Default value (Engineering tool)	Cam data operation function
Cam No.	Set the cam No.	0: Linear cam 1 to 64: User created cam for 4-axis module (Cam storage area) 1 to 128: User created cam for 8-axis module (Cam storage area) 1 to 256: User created cam for 4-/8- axis module (Cam open area)	1	[Cd.601] Operation cam No.
Cam data format	Set "2". (Setting with the engineering tool is not required.)	2: Coordinate data format	2	[Cd.604] Cam data format
Coordinate number	Set the number of coordinate points in one cam cycle. The coordinates are included at the 0th point.	2 to 8192	2	[Cd.605] Cam resolution/ coordinate number
Cam data starting point	Setting is not required with coordinate data format.	—	—	[Cd.606] Cam data starting point
Coordinate data	Set all coordinate data (input value: $X_n$ , output value: $Y_n$ ). Required to set the coordinate data ( $X_0$ , $Y_0$ ) from the 0th point. The input value should be larger than the previous coordinate data ( $X_n < X_{n+1}$ ).	Input value: 0 to 2147483647 [Cam axis cycle units] Output value: -2147483648 to 2147483647 [Output axis position units]	0	[Cd.607] Cam data value

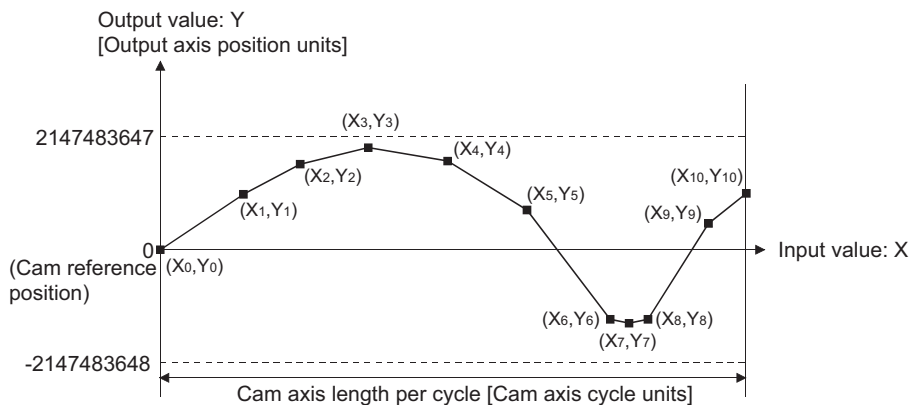

When an input value that is 0 or the cam axis length per cycle does not exist in the coordinate data, the coordinate is calculated from the line segment between the nearest two coordinates.

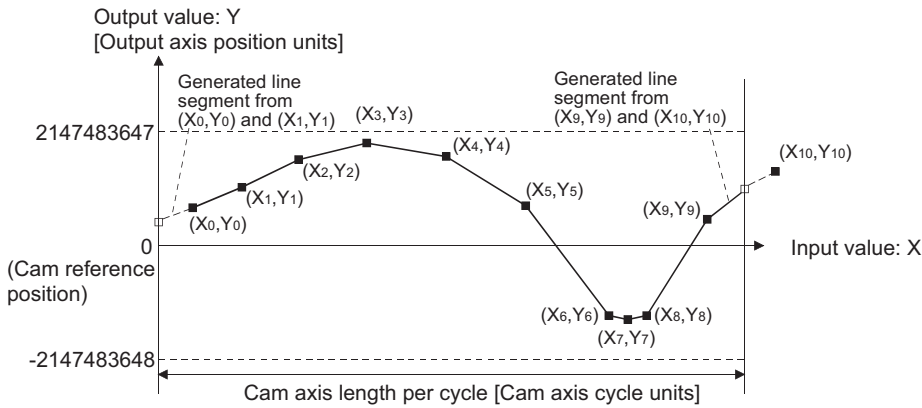

### ■Auto-generation data format

A cam pattern is created based on the specified parameter (data for auto-generation). Control cam data is created in the stroke ratio data format in the cam open area. Therefore, the operation specification during the control conforms to the cam operation in the stroke ratio data format.

The types of cam patterns for auto-generation data format are as follows.

Auto-generation type	Features
Cam for rotary cutter	The cam pattern for a rotary cutter can be created easily.

## ⚠ CAUTION

If the cam data is set incorrectly, similarly to the incorrect setting of a target value and command speed in the positioning control, the position and speed command to the servo amplifier increases, and may cause machine interface and servo alarms such as "Overspeed" and "Command frequency error". When creating and changing cam data, execute a trial operation and provide the appropriate adjustments. Refer to the following for precautions on test operations and adjustments. (Page 1 SAFETY PRECAUTIONS)

### Feed current value of cam axis

The feed current value is calculated as shown below.

#### ■Stroke ratio data format

Feed current value = Cam reference position + (Cam stroke amount × Stroke ratio corresponding to cam axis current value per cycle)

#### ■Coordinate data format

Feed current value = Cam reference position + Output value corresponding to cam axis current value per cycle

When the cam axis current value per cycle is in the middle of the defined cam data (Stroke ratio data/Coordinate data), the value is calculated from the nearest cam data.

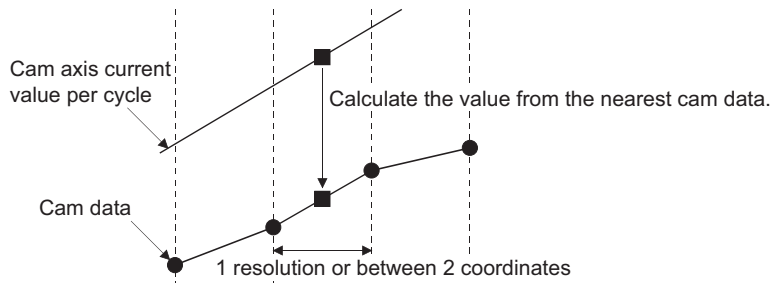

## Cam reference position

The cam reference position is calculated as shown below.

### ■Stroke ratio data format

Cam reference position = The preceding cam reference position + (Cam stroke amount × Stroke ratio at the last point)

### ■Coordinate data format

Cam reference position = The preceding cam reference position + Output value corresponding to "Input value = Cam axis length per cycle" - Output value corresponding to "Input value = 0"

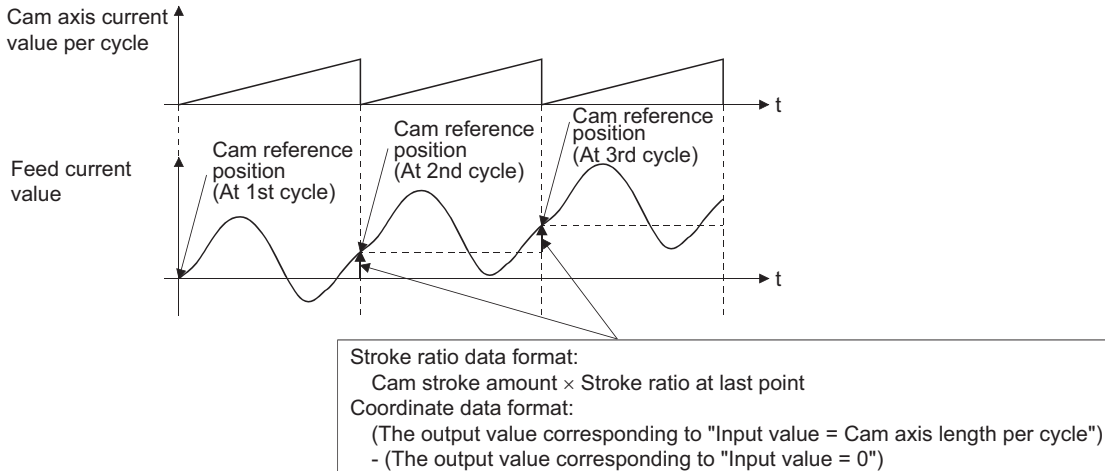

Create cam data for two-way cam operation as shown below.

### ■Stroke ratio data format

Create cam data so that the stroke ratio is 0% at the last point.

### ■Coordinate data format

Create cam data with the same output value for the point where the input value is 0 and the input value is equal to the cam axis length per cycle.

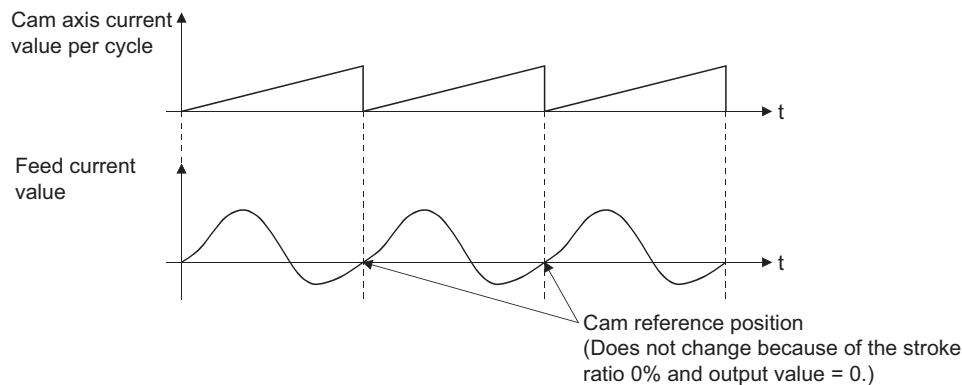

## Cam data starting point

This setting is only valid for cam data using the stroke ratio data format.

The cam data point corresponding to "Cam axis current value per cycle = 0" can be set as the cam data starting point.

The default value of the cam data starting point is 0. (The cam axis is controlled with cam data starting from the 0th point (stroke ratio 0%).)

When a value other than 0 is set for the cam data starting point, cam control is started from the point where the stroke ratio is not 0%.

The cam data starting point is set for each cam data. The setting range is from 0 to (cam resolution - 1).

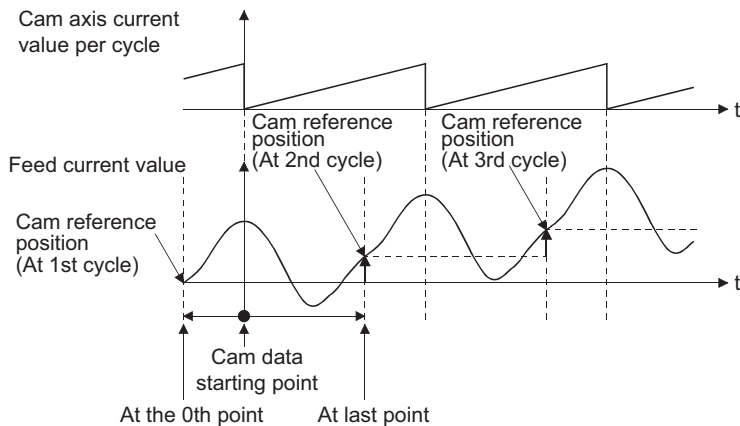

## Timing of applying cam control data

### ■Stroke ratio data format

If "[Pr.440] Cam No." or "[Pr.441] Cam stroke amount" is changed during synchronous control, the new value is accepted and applied when the cam axis current value per cycle passes through the 0th point of cam data, or is on the 0th point.

The cam reference position is updated when the cam axis current value per cycle passes through the 0th point of cam data.

### ■Coordinate data format

If "[Pr.440] Cam No." is changed during synchronous control, the new value is accepted and applied when the cam axis current value per cycle passes through 0, or is on 0.

The cam reference position is updated when the cam axis current value per cycle passes through 0.



## 3.2 Create Cam Data

### Memory configuration of cam data

Cam data is arranged in the following 2 areas.

Memory configuration	Storage item	Details	Remark
Cam storage area	Cam data	Data is written by the following operations. <ul style="list-style-type: none"><li>• Write with the engineering tool</li><li>• When executing "write (Cam storage area)" with the cam data operation function</li></ul>	• Data is preserved even when turning the power supply OFF.
	Cam auto-generation data	Data is written when the cam auto-generation request is executed. (Cam auto-generation function)	
Cam open area	Cam data	Cam data is transmitted from the cam storage area by the following operations. <ul style="list-style-type: none"><li>• Power supply turn ON</li><li>• Write to the cam storage area</li><li>• "[Cd.190] PLC READY signal" OFF to ON</li><li>• When specifying the cam open area with the cam data operation function</li><li>• When executing the cam auto-generation function</li></ul>	<ul style="list-style-type: none"><li>• Data is lost when turning the power supply OFF.</li><li>• The cam data that is used in cam control is stored.</li></ul>

Previously written cam data can be used after turning the power supply OFF by writing data in the cam storage area. Cam data should be written in the cam storage area for normal use.

It is possible to write directly to the cam open area via buffer memory when registering cam data that exceeds the memory capacity in the cam storage area, etc. (Page 90 Cam data operation function) However, writing must be executed to the cam open area every time due to clearing the data at the power supply OFF.

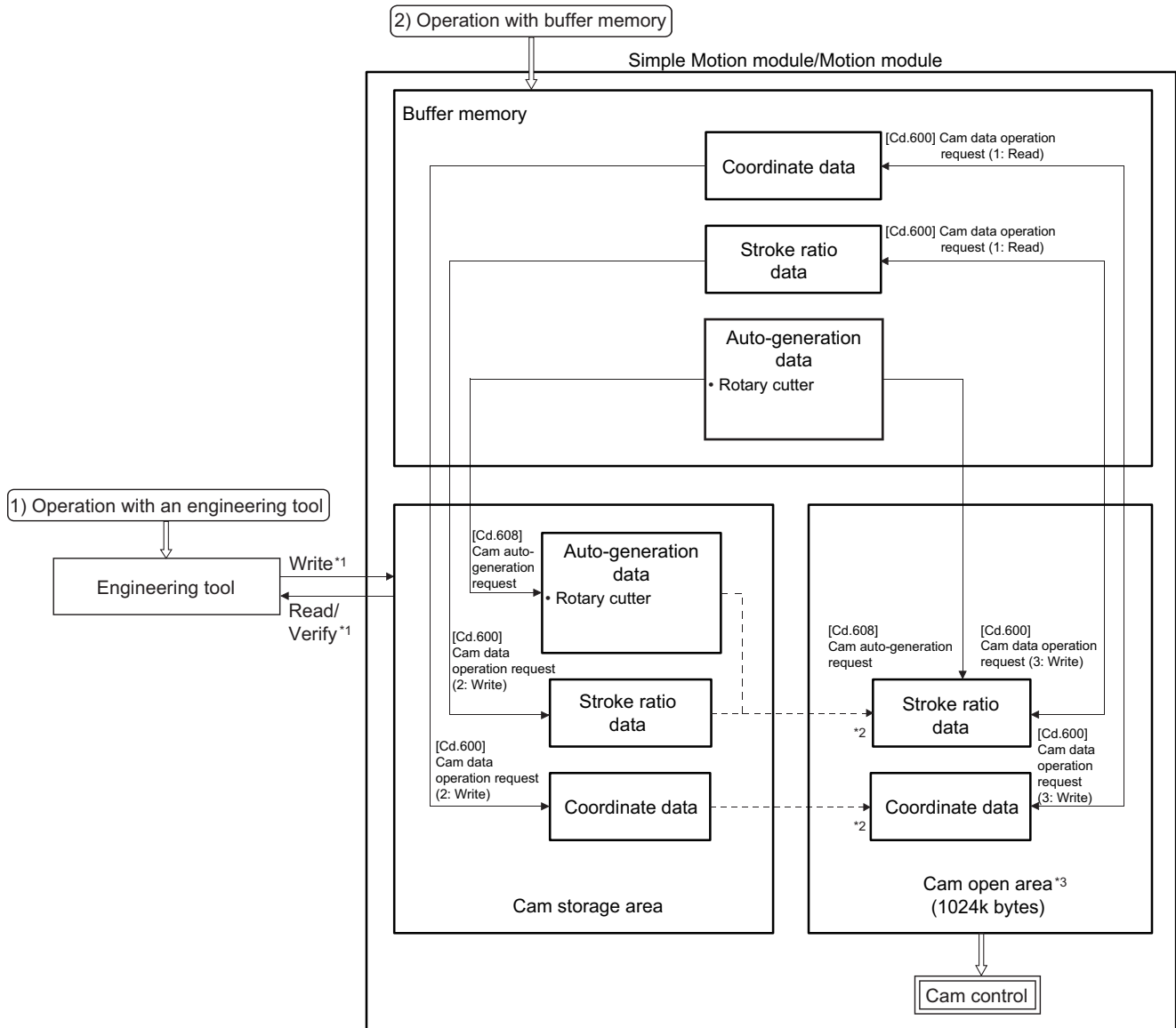

\*1 The operation from the engineering tool is executed toward cam storage area.

\*2 Writing to cam storage area is transmitted in the following timing.

- Power supply turn ON
- Write to cam storage area
- "[Cd.190] PLC READY signal" OFF to ON

\*3 Data in the cam storage area is cleared when the power supply is turned ON again or reset.

## Cam data operation with an engineering tool

Cam data can be modified while viewing the waveform with the engineering tool.

The cam data is written/read/verified to the cam storage area with the engineering tool, however it cannot be executed to the cam open area.

The waveform generated by the cam auto-generation function can be confirmed by the "Cam graph" on the "Cam Data" window from the Navigation window ⇒ "Cam Data" through reading with the engineering tool.

## Cam data operation with buffer memory

It is possible to specify the area where cam data is written. The cam data is read from the cam open area. (Page 90 Cam data operation function)

With the cam auto-generation function, auto-generation data is saved in the cam storage area, and the cam data is generated into the cam open area.

## Cam data capacity

The size of the created cam data is shown below for the cam storage area/cam open area.

Operation method	Data method/Auto-generation type	Cam storage area (65536 bytes)	Cam open area (1048576 bytes)
Create with an engineering tool	Stroke ratio data format	Cam resolution × 4 bytes	Cam resolution × 4 bytes
	Coordinate data format	Coordinate number × 8 bytes	Coordinate number × 8 bytes
Create in cam storage area with cam data operation function	Stroke ratio data format	Cam resolution × 4 bytes	Cam resolution × 4 bytes
	Coordinate data format	Coordinate number × 8 bytes	Coordinate number × 8 bytes
Create in cam open area with cam data operation function	Stroke ratio data format	0 byte	Cam resolution × 4 bytes
	Coordinate data format		Coordinate number × 8 bytes
Create with cam auto-generation	For a rotary cutter	28 bytes	Cam resolution × 4 bytes

When writing with the cam data operation function or when the cam auto-generation function is executed, the writing area free capacity size may decrease since the size changes depending on the cam resolution change, etc. In this case, write the cam data with the engineering tool or delete them once.

## Delete method of cam data

The data of cam storage area/cam open area can be deleted (initialize) by the parameter initialization function with a parameter setting and positioning data. The parameter initialization function is executed by setting "1" in "[Cd.2] Parameter initialization request".

Write the empty data in the cam storage area with the engineering tool to delete only cam data.

## Password protection for cam data

The cam data can be protected as shown below by password setting.

Password setting	Cam data operation with an engineering tool	Cam data operation with buffer memory
Password for read protection	Cam data cannot be read without password for read protection.	Reading cam data is not operated.
Password for write protection	Cam data cannot be written without password for write protection.	Writing cam data and generating cam data auto-generation is not operated.

The password for cam data is deleted with cam data by "[Cd.2] Parameter initialization request".

# Cam data operation function

This function is used to write/read cam data via buffer memory with the cam operation control data. To operate the points more than the amount of data for each operation (as follows), the operation should be executed separately.

Cam data format	Amount of data for each operation
Stroke ratio data format	4096
Coordinate data format	2048

## Cam operation control data

Setting item	Setting details	Setting value (Read operation: Stored value)	Default value	Buffer memory address
[Cd.600] Cam data operation request	<ul style="list-style-type: none"> <li>Set the command for operating cam data.</li> <li>The Simple Motion module/Motion module resets the value to "0" automatically after completion of cam data operation.</li> </ul> Fetch cycle: Main cycle <sup>*1</sup>	■Set in decimal. 1: Read (Cam open area) 2: Write (Cam storage area) 3: Write (Cam open area)	0	45000
[Cd.601] Operation cam No.	<ul style="list-style-type: none"> <li>Set the operating cam No.</li> </ul> Fetch cycle: At requesting cam data operation	■Set in decimal. 4-axis module: 1 to 64 (Cam storage area) 8-axis module: 1 to 128 (Cam storage area) 4-axis module/8-axis module: 1 to 256 (Cam open area)	0	45001
[Cd.602] Cam data first position	<ul style="list-style-type: none"> <li>Set the first position for the operating cam data.</li> </ul> Fetch cycle: At requesting cam data operation	■Set in decimal. <ul style="list-style-type: none"> <li>Stroke ratio data format 1 to cam resolution</li> <li>Coordinate data format 0 to (Coordinate number - 1)</li> </ul>	0	45002
[Cd.603] Number of cam data operation points	<ul style="list-style-type: none"> <li>Set the number of operating cam data points.</li> </ul> Fetch cycle: At requesting cam data operation	■Set in decimal. <ul style="list-style-type: none"> <li>Stroke ratio data format 1 to 4096</li> <li>Coordinate data format 1 to 2048</li> </ul>	0	45003
[Cd.604] Cam data format	<ul style="list-style-type: none"> <li>Write operation: Set cam data format.</li> </ul> Fetch cycle: At requesting cam data operation <ul style="list-style-type: none"> <li>Read operation: The cam data format is stored</li> </ul> Refresh cycle: At completing cam data operation	■Set in decimal. 1: Stroke ratio data format 2: Coordinate data format	0	45004
[Cd.605] Cam resolution/coordinate number	<ul style="list-style-type: none"> <li>Write operation: Set the cam resolution/the coordinate number.</li> </ul> Fetch cycle: At requesting cam data operation <ul style="list-style-type: none"> <li>Read operation: The cam resolution/the coordinate number is stored.</li> </ul> Refresh cycle: At completing cam data operation	■Set in decimal. <ul style="list-style-type: none"> <li>Stroke ratio data format 256/512/1024/2048/4096/8192/16384</li> <li>Coordinate data format 2 to 8192</li> </ul>	0	45005
[Cd.606] Cam data starting point	<ul style="list-style-type: none"> <li>Write operation: Set the cam data starting point.</li> </ul> Fetch cycle: At requesting cam data operation <ul style="list-style-type: none"> <li>Read operation: The cam data starting point is stored.</li> </ul> Refresh cycle: At completing cam data operation <ul style="list-style-type: none"> <li>Setting is not required with coordinate data format.</li> </ul>	■Set in decimal. <ul style="list-style-type: none"> <li>Stroke ratio data format 0 to (Cam resolution - 1)</li> <li>Coordinate data format Setting not required</li> </ul>	0	45006
[Cd.607] Cam data value	<ul style="list-style-type: none"> <li>Write operation: Set the cam data corresponding to the cam data format.</li> </ul> Fetch cycle: At requesting cam data operation <ul style="list-style-type: none"> <li>Read operation: The cam data is stored.</li> </ul> Refresh cycle: At completing cam data operation	■Set in decimal. <ul style="list-style-type: none"> <li>Stroke ratio data format -2147483648 to 2147483647[<math>\times 10^{-7}\%</math>]</li> <li>Coordinate data format Input value: 0 to 2147483647 [Cam axis cycle units<sup>*2</sup>] Output value: -2147483648 to 2147483647 [Output axis position units<sup>*3</sup>]</li> </ul>	0	45008 to 53199

\*1 With the exception of positioning control, main cycle processing is executed during the next available time. It changes by status of axis start.

\*2 Cam axis cycle units (☞ Page 127 Units for the output axis)

\*3 Output axis position units (☞ Page 127 Units for the output axis)

## [Cd.600] Cam data operation request

Set the following commands to write/read cam data.

Setting value	Details
1: Read (Cam open area)	The cam is read from the cam open area and stored to the buffer memory.
2: Write (Cam storage area)	The cam data is written to the cam storage area and the cam open area from the buffer memory.
3: Write (Cam open area)	The cam data is written to the cam open area from the buffer memory.

The setting value is reset to "0" automatically after completion of cam data operation.

If a warning occurs when requesting cam data operation, the warning No. is stored in "[Md.24] Axis warning No." of axis 1, and the setting value is reset to "0" automatically.

When another request command is set, the operation does not get executed and the setting value is reset to "0" automatically.

## [Cd.601] Operation cam No.

Set the cam No. to write/read.

## [Cd.602] Cam data first position

Set the first position of the cam data to write/read.

Set the cam data first position within the range from 1 to the cam resolution in cam resolution units using the stroke ratio data format. The stroke ratio of the 0th cam data is 0% fixed, and this data cannot be written/read.

Set a value within the range from 0 to (Coordinate number - 1) with the coordinate data format.

## [Cd.603] Number of cam data operation points

Set the number of operation points to write/read starting from the first position of cam data.

- Stroke ratio data format

The following shows the operation details when the value of "Cam data first position + Cam data operation points - 1" is larger than the cam resolution in the stroke ratio data format.

Operation	Details
Reading	The cam data from the first position to the cam resolution is read in the buffer memory.
Writing	The warning "Outside number of cam data operation points range" (warning code: 0C43H [FX5-SSC-S], or warning code: 0E93H [FX5-SSC-G]) occurs, and writing is not executed.

- Coordinate data format

The following shows the operation details when the value of "Cam data first position + Cam data operation points" is larger than the coordinate number with the coordinate data format.

Operation	Details
Reading	The cam data from the first position to the last coordinate is read in the buffer memory.
Writing	The warning "Outside number of cam data operation points range" (warning code: 0C43H [FX5-SSC-S], or warning code: 0E93H [FX5-SSC-G]) occurs, and writing is not executed.

## [Cd.604] Cam data format

Set one of the following cam data formats.

Setting value	Details
1	Stroke ratio data format
2	Coordinate data format

## [Cd.605] Cam resolution/coordinate number

Set/load the cam resolution/the coordinate number.

Operation	Details
Reading	The cam resolution/the coordinate number of the set cam data is read.
Writing	Set the cam resolution with the following values when using the stroke ratio data format. 256/512/1024/2048/4096/8192/16384 Set the coordinate number within the range from 2 to 8192 when using the coordinate data format.

## [Cd.606] Cam data starting point

Set/load the cam data starting point. This is used with the stroke ratio data format.

Operation	Details
Reading	The cam starting point of the set cam data is read.
Writing	Set the cam data starting point within the range from 0 to (Cam resolution - 1).

## [Cd.607] Cam data value

Set/load the cam data operation points according to one of the following formats.

### ■Stroke ratio data format

Buffer memory address	Item	Setting value
45008 45009	Stroke ratio at first point	-2147483648 to 2147483647[ $\times 10^{-7}\%$ ] (-214.7483648 to 214.7483647[%])
45010 45011	Stroke ratio at second point	
⋮	⋮	
53198 53199	Stroke ratio at 4096th point	

### ■Coordinate data format

Buffer memory address	Item		Setting value
45008 45009	At first point	Input value	0 to 2147483647 [Cam axis cycle unit]
45010 45011		Output value	-2147483648 to 2147483647 [Output axis position unit]
45012 45013	At second point	Input value	0 to 2147483647 [Cam axis cycle unit]
45014 45015		Output value	-2147483648 to 2147483647 [Output axis position unit]
⋮	⋮		⋮
53196 53197	At 2048th point	Input value	0 to 2147483647 [Cam axis cycle unit]
53198 53199		Output value	-2147483648 to 2147483647 [Output axis position unit]

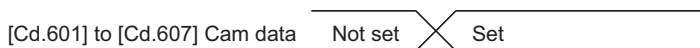

## Cam auto-generation function

The cam auto-generation function is used to generate cam data automatically for specific purposes based on parameter settings.

With this function, cam data is generated in the cam open area.

It is possible to generate up to 1 Mbyte including the regular cam data. (Example: 64 cam data (with the stroke ratio format, resolution is 4096) can be automatically generated.)

The processing time of cam auto-generation takes longer if the data point is larger. Also, the real processing time changes by status of axis start etc.

(Reference) Relationship between the cam resolution and processing time in the cam auto-generation (Stroke ratio data format)

[FX5-SSC-S]

Operation cycle [ms]	Cam resolution		
	256	2048	16384
0.888	0.43 [ms]	3.7 [ms]	29 [ms]
1.777	0.78 [ms]	3.5 [ms]	25 [ms]

[FX5-SSC-G]

Upper limit number of control axes	Operation cycle [ms]	Cam resolution		
		256	4096	16384
2	0.500	1.5 [ms]	20 [ms]	35 [ms]
4	0.500	50 [ms]	207 [ms]	612 [ms]
4	1.000	0.94 [ms]	5.2 [ms]	26 [ms]
8	1.000	5.0 [ms]	12 [ms]	40 [ms]
8	2.000	0.41 [ms]	4.0 [ms]	14 [ms]
8	4.000	0.50 [ms]	0.66 [ms]	1.9 [ms]

### Cam operation control data

Setting item	Setting details	Setting value	Default value	Buffer memory address
[Cd.608] Cam auto-generation request	<ul style="list-style-type: none"> <li>Set the request for cam auto-generation.</li> <li>The Simple Motion module/Motion module resets the value to "0" automatically after completion of the cam auto-generation.</li> </ul> Fetch cycle: Main cycle* <sup>1</sup>	■Set in decimal. 1: Cam auto-generation request	0	53200
[Cd.609] Cam auto-generation cam No.	<ul style="list-style-type: none"> <li>Set the cam No. to be generated automatically.</li> </ul> Fetch cycle: At requesting cam auto-generation	■Set in decimal. 4-axis module: 1 to 64 8-axis module: 1 to 128	0	53201
[Cd.610] Cam auto-generation type	<ul style="list-style-type: none"> <li>Set the type of cam auto-generation.</li> </ul> Fetch cycle: At requesting cam auto-generation	■Set in decimal. 1: Cam for rotary cutter	0	53202
[Cd.611] Cam auto-generation data	<ul style="list-style-type: none"> <li>Set the parameters for each type of cam auto-generation.</li> </ul> Fetch cycle: At requesting cam auto-generation	(  Page 95 [Cd.611] Cam auto-generation data)	0	53204 to 53779

\*1 With the exception of positioning control, main cycle processing is executed during the next available time. It changes by status of axis start.

### **[Cd.608] Cam auto-generation request**

Set "1: Cam auto-generation request" to execute cam auto-generation.

Cam data is generated in the cam open area of the specified cam No. based on the cam auto-generation data.

The setting value is reset to "0" automatically after completing the process.

The cam auto-generation data is saved in the cam storage area. The cam auto-generation is executed automatically again when the next power supply turns ON or "[Cd.190] PLC READY signal" OFF to ON.

If a warning occurs when requesting cam auto-generation, the warning No. is stored in "[Md.24] Axis warning No." of axis 1, and the setting value is reset to "0" automatically.

When another request command is set, this function does not get executed and the setting value is reset to "0" automatically.

### **[Cd.609] Cam auto-generation cam No.**

Set the cam No. to be generated automatically.

### **[Cd.610] Cam auto-generation type**

Set the type of cam auto-generation.



## [Cd.611] Cam auto-generation data

Set the cam auto-generation data corresponding to "[Cd.610] Cam auto-generation type".

### ■For a rotary cutter

The cam data starting point for a rotary cutter is 0.

Buffer memory address	Item	Setting value	Details
53204	Cam resolution	256/512/1024/2048/4096/8192/16384	Set the cam resolution for generating the cam.
53206 53207	Sheet length	1 to 2147483647 [[Optional] Same unit (0.1 mm, etc.)]	Set the sheet length. Set this value in the cam axis length per cycle.
53208 53209	Sheet synchronization width	1 to 2147483647 [[Optional] Same unit (0.1 mm, etc.)]	Set the sheet length of the synchronous section.
53210 53211	Synchronous axis length	1 to 2147483647 [[Optional] Same unit (0.1 mm, etc.)]	Set the cycle length of the rotary cutter shaft.
53212 53213	Synchronization starting point	0 to 2147483647 [[Optional] Same unit (0.1 mm, etc.)]	Set the length from the beginning of the sheet to the start of the synchronous section.
53214	Synchronous section acceleration ratio	-5000 to 5000 [0.01%]	Set when the synchronous speed in the synchronous section needs to be adjusted. The speed is "Synchronous speed × (100% + Acceleration ratio)" in the synchronous section.

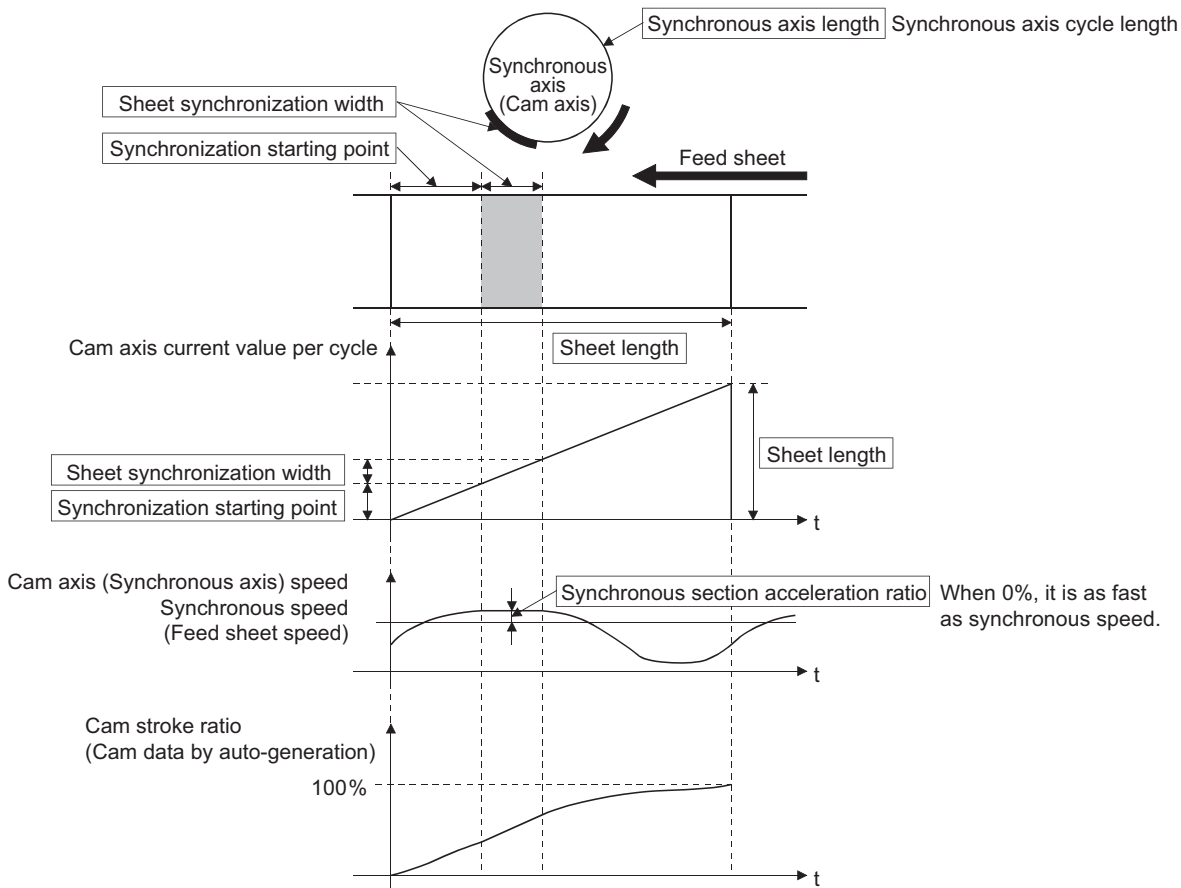

# 4 ADVANCED SYNCHRONOUS CONTROL

The parameters and monitor data for synchronous control such as "Main shaft module", "Speed change gear module", and "Output axis module" are explained in this chapter.

Configure the required settings according to the control and application requirements for each module.

## 4.1 Main Shaft Module

### Overview of main shaft module

For the main shaft module, the input value is generated as a composite value from two input axes (the main and sub input axis) through the composite main shaft gear. The composite input value can be converted by the main shaft gear that provides the deceleration ratio and the rotation direction for the machine system, etc.

Refer to the following for details on setting for the main shaft module.

☞ Page 96 Main shaft parameters, ☞ Page 99 Main shaft clutch parameters

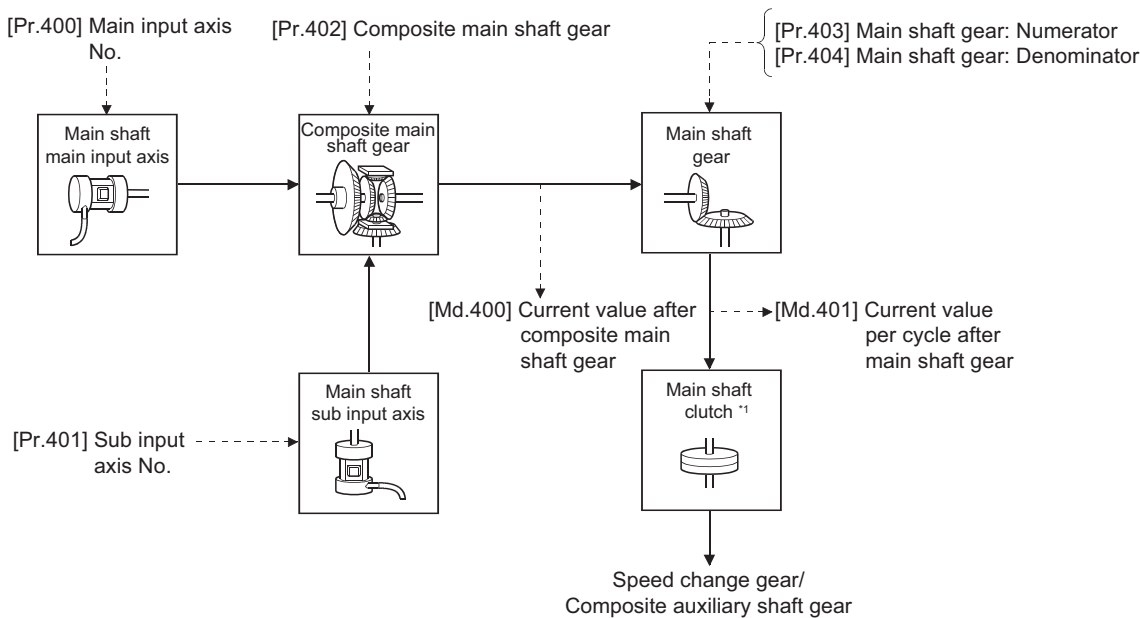

\*1 ☞ Page 113 Clutch

### Main shaft parameters

n: Axis No. - 1

Setting item	Setting details	Setting value	Default value	Buffer memory address
[Pr.400] Main input axis No.	<ul style="list-style-type: none"> <li>Set the input axis No. on the main input side for the main shaft.</li> </ul> <u>Fetch cycle: At start of synchronous control</u>	<ul style="list-style-type: none"> <li>Set in decimal.</li> <li>0: Invalid</li> <li>1 to 8: Servo input axis*1</li> <li>201 to 208: Command generation axis*1</li> <li>801 to 804: Synchronous encoder axis</li> </ul>	0	36400+200n
[Pr.401] Sub input axis No.	<ul style="list-style-type: none"> <li>Set the input axis No. on the sub input side for the main shaft.</li> </ul> <u>Fetch cycle: At start of synchronous control</u>	<ul style="list-style-type: none"> <li>Set in decimal.</li> <li>0: Invalid</li> <li>1 to 8: Servo input axis*1</li> <li>201 to 208: Command generation axis*1</li> <li>801 to 804: Synchronous encoder axis</li> </ul>	0	36401+200n



## [Pr.403] Main shaft gear: Numerator, [Pr.404] Main shaft gear: Denominator

Set the numerator and the denominator for the main shaft gear to convert the input value. The input value is converted as follows.

$$\text{Input value after conversion} = \text{Input value before conversion} \times \frac{[\text{Pr.403}] \text{ Main shaft gear: Numerator}}{[\text{Pr.404}] \text{ Main shaft gear: Denominator}}$$

The input value direction can be reversed by setting a negative value in the numerator of the main shaft gear.

Set the denominator of the main shaft gear to a value within the range from 1 to 2147483647.

### Ex.

Convert the cam axis per cycle to be controlled in intervals of 0.1 mm (0.00394 inch). The cam axis synchronizes with a conveyer that moves 100 mm (3.937 inch) for every (360.00000 degree) of the main shaft.

"[Pr.403] Main shaft gear: Numerator": 1000 [ × 0.1 mm]

"[Pr.404] Main shaft gear: Denominator": 36000000 [ × 10<sup>-5</sup> degree]

# Main shaft clutch parameters

n: Axis No. - 1

Setting item	Setting details	Setting value	Default value	Buffer memory address
[Pr.405] Main shaft clutch control setting	<ul style="list-style-type: none"> <li>Set the control method for the clutch.</li> </ul> <u>Fetch cycle: Operation cycle</u>	<p>■Set in hexadecimal.</p>	0000H	36408+200n
[Pr.406] Main shaft clutch reference address setting	<ul style="list-style-type: none"> <li>Set the reference address for the clutch.</li> </ul> <u>Fetch cycle: At start of synchronous control</u>	<p>■Set in decimal.</p> <p>0: Current value after composite main shaft gear</p> <p>1: Current value per cycle after main shaft gear</p>	0	36409+200n
[Pr.407] Main shaft clutch ON address	<ul style="list-style-type: none"> <li>Set the clutch ON address for address mode. (This setting is invalid except during address mode.)</li> <li>If the address is out of the range from 0 to (Cam axis length per cycle - 1), the address is converted to a value within range.</li> </ul> <u>Fetch cycle: Operation cycle</u>	<p>■Set in decimal.</p> <p>-2147483648 to 2147483647</p> <p>[Main input axis position units<sup>*2</sup>, or cam axis cycle units<sup>*3</sup>]</p>	0	36410+200n 36411+200n
[Pr.408] Movement amount before main shaft clutch ON	<ul style="list-style-type: none"> <li>Set the movement amount between the clutch ON condition completing and the clutch closing.</li> <li>Set a positive value when the reference address is increasing, and a negative value when it is decreasing.</li> </ul> <u>Fetch cycle: At completing clutch ON condition</u>	<p>■Set in decimal.</p> <p>-2147483648 to 2147483647</p> <p>[Main input axis position units<sup>*2</sup>, or cam axis cycle units<sup>*3</sup>]</p>	0	36412+200n 36413+200n
[Pr.409] Main shaft clutch OFF address	<ul style="list-style-type: none"> <li>Set the clutch OFF address for the address mode. (This setting is invalid except during address mode.)</li> <li>If the address is out of the range from 0 to (Cam axis length per cycle - 1), the address is converted to a value within range.</li> </ul> <u>Fetch cycle: Operation cycle</u>	<p>■Set in decimal.</p> <p>-2147483648 to 2147483647</p> <p>[Main input axis position units<sup>*2</sup>, or cam axis cycle units<sup>*3</sup>]</p>	0	36414+200n 36415+200n
[Pr.410] Movement amount before main shaft clutch OFF	<ul style="list-style-type: none"> <li>Set the movement amount between the clutch OFF condition completing and the clutch opening.</li> <li>Set a positive value when the reference address is increasing, and a negative value when it is decreasing.</li> </ul> <u>Fetch cycle: At completing clutch OFF condition</u>	<p>■Set in decimal.</p> <p>-2147483648 to 2147483647</p> <p>[Main input axis position units<sup>*2</sup>, or cam axis cycle units<sup>*3</sup>]</p>	0	36416+200n 36417+200n
[Pr.411] Main shaft clutch smoothing method	<ul style="list-style-type: none"> <li>Set the clutch smoothing method.</li> </ul> <u>Fetch cycle: At start of synchronous control</u>	<p>■Set in decimal.</p> <p>0: Direct</p> <p>1: Time constant method (Exponent)</p> <p>2: Time constant method (Linear)</p> <p>3: Slippage method (Exponent)</p> <p>4: Slippage method (Linear)</p> <p>5: Slippage method (Linear: Input value follow up)</p>	0	36418+200n
[Pr.412] Main shaft clutch smoothing time constant	<ul style="list-style-type: none"> <li>For smoothing with a time constant method, set the smoothing time constant.</li> </ul> <u>Fetch cycle: At start of synchronous control</u>	<p>■Set in decimal.</p> <p>0 to 5000 [ms]</p>	0	36419+200n

Setting item	Setting details	Setting value	Default value	Buffer memory address
[Pr.413] Slippage amount at main shaft clutch ON	<ul style="list-style-type: none"> <li>For smoothing with a slippage method, set the slippage amount at clutch ON.</li> </ul> <u>Fetch cycle: At turning clutch ON</u>	■Set in decimal. 0 to 2147483647 [Main input axis position units <sup>*2</sup> , or cam axis cycle units <sup>*3</sup> ]	0	36420+200n 36421+200n
[Pr.414] Slippage amount at main shaft clutch OFF	<ul style="list-style-type: none"> <li>For smoothing with a slippage method, set the slippage amount at clutch OFF.</li> </ul> <u>Fetch cycle: At turning clutch OFF</u>	■Set in decimal. 0 to 2147483647 [Main input axis position units <sup>*2</sup> , or cam axis cycle units <sup>*3</sup> ]	0	36422+200n 36423+200n

\*1 The range from axis 1 to 4 is valid in the 4-axis module and from axis 1 to 8 is valid in the 8-axis module.

\*2 Main input axis position units (☞ Page 27 INPUT AXIS MODULE)

\*3 Cam axis cycle units (☞ Page 127 Units for the output axis)

## [Pr.405] Main shaft clutch control setting

Set the ON and OFF control methods separately for the main shaft clutch.

The clutch control setting can be changed during synchronous control, however, the setting "No clutch" (Direct coupled operation) cannot be selected during synchronous control after already selecting another setting.

Refer to the following for operation details on the clutch control.

☞ Page 113 Control method for clutch

### ■ON control mode

Setting value	Details
0: No clutch (Direct coupled operation)	Execute direct coupled operation without clutch control.
1: Clutch command ON/OFF	The clutch is turned ON/OFF by the operation of "[Cd.400] Main shaft clutch command" ON/OFF. (Setting in the OFF control mode are not applicable in the clutch command ON/OFF mode.)
2: Clutch command leading edge	The clutch is turned ON when "[Cd.400] Main shaft clutch command" passes the leading edge (from OFF to ON).
3: Clutch command trailing edge	The clutch is turned ON when "[Cd.400] Main shaft clutch command" passes the trailing edge (from ON to OFF).
4: Address mode	The clutch is turned ON when the reference address (the current value after composite main shaft gear or the current value per cycle after main shaft gear) reaches "[Pr.407] Main shaft clutch ON address". The movement amount after passing through the ON address is calculated as the output movement amount of the clutch based on the reference address passing through, thereby controlling the clutch with an accurate movement amount.
5: High speed input request	The clutch is turned ON when the high speed input request [DI] turns ON.

#### Point

Other clutch parameters are not applicable during direct coupled operation by setting "0: No clutch". "[Cd.402] Main shaft clutch forced OFF command" and the change of the clutch control setting are ignored during direct coupled operation.

### ■OFF control mode

Setting value	Details
0: OFF control invalid	Clutch OFF control is not used. This setting is applicable only for execution with clutch ON control.
1: One-shot OFF	The clutch is turned OFF after moving the distance "[Pr.410] Movement amount before main shaft clutch OFF" (One-shot operation) after the clutch command turns ON. If "[Pr.410] Movement amount before main shaft clutch OFF" is 0, "[Md.420] Main shaft clutch ON/OFF status" does not turn ON in order to turn back OFF immediately.
2: Clutch command leading edge	The clutch is turned OFF when "[Cd.400] Main shaft clutch command" passes the leading edge (from OFF to ON).
3: Clutch command trailing edge	The clutch is turned OFF when "[Cd.400] Main shaft clutch command" passes the trailing edge (from ON to OFF).
4: Address mode	The clutch is turned OFF when the reference address (the current value after composite main shaft gear or the current value per cycle after main shaft gear) reaches "[Pr.409] Main shaft clutch OFF address". The movement amount before passing through the OFF address is calculated as the output movement amount of the clutch based on the reference address passing through, thereby controlling the clutch with an accurate movement amount.
5: High speed input request	The clutch is turned OFF when the high speed input request [DI] turns ON.

### High speed input request signal

Set the high speed input request signal No. for the ON control mode (1) and the OFF control mode (2) when using the setting "5: High speed input request".

Signal No.	Setting value (Hexadecimal)	Signal No.	Setting value (Hexadecimal)
1	0	5	4
2	1	6	5
3	2	7	6
4	3	8	7

### [Pr.406] Main shaft clutch reference address setting

Select the address type to be used as the reference address for clutch control. Note that the processing order of the main shaft gear and the main shaft clutch will change depending on the reference address setting.

Setting value	Details
0: Current value after composite main shaft gear	The clutch is controlled by using the current value after composite main shaft gear as a reference. Output after the clutch is a converted movement amount through the main shaft gear.
1: Current value per cycle after main shaft gear	The clutch is controlled by using the current value per cycle after main shaft gear. Output after the clutch is a movement amount without conversion.

The setting values for the following parameters are in units based on the reference address setting.

- "[Pr.407] Main shaft clutch ON address"
- "[Pr.409] Main shaft clutch OFF address"
- "[Pr.408] Movement amount before main shaft clutch ON", "[Pr.410] Movement amount before main shaft clutch OFF"
- "[Pr.413] Slippage amount at main shaft clutch ON", "[Pr.414] Slippage amount at main shaft clutch OFF"

### [Pr.407] Main shaft clutch ON address

Set the clutch ON address when address mode is configured for the ON control mode of the main shaft clutch.

When the reference address is the current value per cycle after main shaft gear, the setting address is converted for control within the range from 0 to (Cam axis length per cycle - 1).

**Ex.**

Cam axis length per cycle: 20000 pulses

The ON address is controlled as 19000 pulses when the setting value is "-1000".

### [Pr.408] Movement amount before main shaft clutch ON

Set the movement amount of the reference address with a signed value between the clutch ON condition completing and the clutch closing.

Setting value	Details
1 to 2147483647 (Positive value)	Used when the reference address is increasing in direction.
0	No movement amount (The clutch is immediately turned ON with the clutch ON condition completing.)
-2147483648 to -1 (Negative value)	Used when the reference address is decreasing in direction.

Clutch ON condition is completed (Example: [Cd.400] Main shaft clutch command ON)

[Md.420] Main shaft clutch ON/OFF status

[Md.400] Current value after composite main shaft gear or

[Md.401] Current value per cycle after main shaft gear

Movement amount after clutch

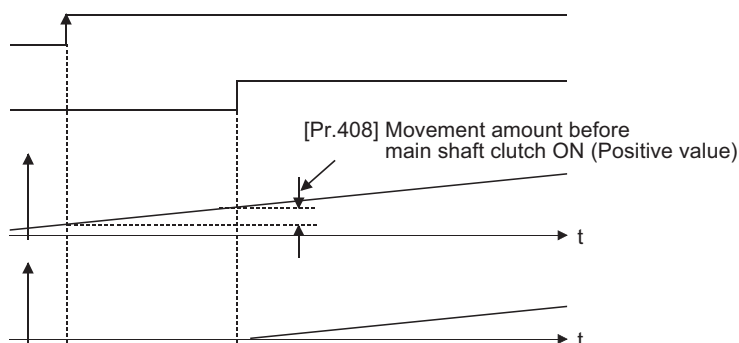

## [Pr.409] Main shaft clutch OFF address

Set the clutch OFF address when address mode is configured for the OFF control mode of the main shaft clutch.  
When the reference address is the current value per cycle after main shaft gear, the setting address is converted for control within the range from 0 to (Cam axis length per cycle - 1).

**Ex.**

Cam axis length per cycle: 20000 pulses

The OFF address is controlled as 60 pulses when the setting value is "40060".

## [Pr.410] Movement amount before main shaft clutch OFF

Set the movement amount of the reference address with a signed value between the clutch OFF condition completing and the clutch opening.

Setting value	Details
1 to 2147483647 (Positive value)	Used when the reference address is increasing in direction.
0	No movement amount (The clutch is immediately turned OFF with the clutch OFF condition completing.)
-2147483648 to -1 (Negative value)	Used when the reference address is decreasing in direction.

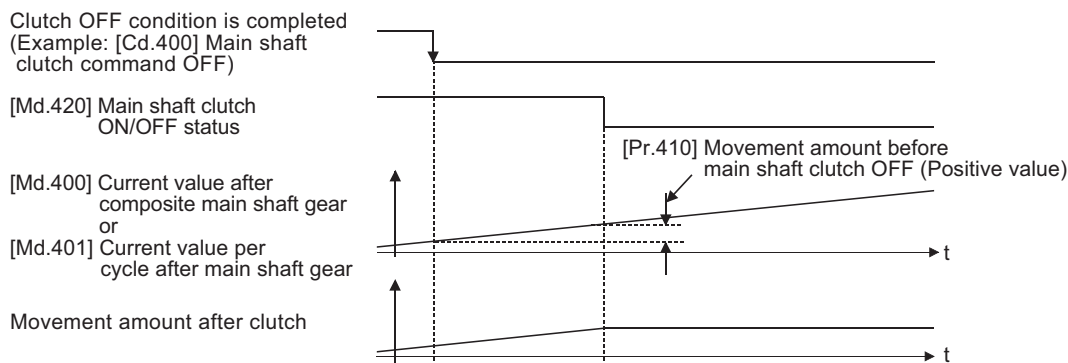

## [Pr.411] Main shaft clutch smoothing method

Set the smoothing method for clutch ON/OFF.

Refer to the following.

☞ Page 118 Smoothing method for clutch

Setting value	Details
0: Direct	No smoothing
1: Time constant method (Exponent)	Smoothing with an exponential curve based on the time constant setting.
2: Time constant method (Linear)	Smoothing with linear acceleration/deceleration based on the time constant setting.
3: Slippage method (Exponent)	Smoothing with an exponential curve based on the slippage amount setting.
4: Slippage method (Linear)	Smoothing with linear acceleration/deceleration based on the slippage amount setting.
5: Slippage method (Linear: Input value follow up)	Smoothing with linear acceleration/deceleration based on the slippage amount setting (input value follow up).

## [Pr.412] Main shaft clutch smoothing time constant

Set a time constant when the time constant method is set in "[Pr.411] Main shaft clutch smoothing method".

The time constant setting applies for clutch ON/OFF.



### **[Pr.413] Slippage amount at main shaft clutch ON**

Set the slippage amount at clutch ON when the slippage method is set in "[Pr.411] Main shaft clutch smoothing method". The slippage amount is set in units based on the current value selected in "[Pr.406] Main shaft clutch reference address setting".

If the set amount is negative, slippage amount at clutch ON is controlled as 0 (direct).

### **[Pr.414] Slippage amount at main shaft clutch OFF**

Set the slippage amount at clutch OFF when the slippage method is set in "[Pr.411] Main shaft clutch smoothing method". The slippage amount is set in units based on the current value selected in "[Pr.406] Main shaft clutch reference address setting".

If the set amount is negative, slippage amount at clutch OFF is controlled as 0 (direct).

# Main shaft clutch control data

n: Axis No. - 1

Setting item	Setting details	Setting value	Default value	Buffer memory address
[Cd.400] Main shaft clutch command	<ul style="list-style-type: none"> <li>Set the clutch command ON/OFF.</li> </ul> <u>Fetch cycle: Operation cycle</u>	<ul style="list-style-type: none"> <li>Set in decimal.</li> <li>0: Main shaft clutch command OFF</li> <li>1: Main shaft clutch command ON</li> </ul>	0	44080+20n
[Cd.401] Main shaft clutch control invalid command	<ul style="list-style-type: none"> <li>Set "1" to disable the clutch control temporarily.</li> </ul> <u>Fetch cycle: Operation cycle</u>	<ul style="list-style-type: none"> <li>Set in decimal.</li> <li>0: Main shaft clutch control valid</li> <li>1: Main shaft clutch control invalid</li> </ul>	0	44081+20n
[Cd.402] Main shaft clutch forced OFF command	<ul style="list-style-type: none"> <li>Set "1" to force the clutch OFF.</li> </ul> <u>Fetch cycle: Operation cycle</u>	<ul style="list-style-type: none"> <li>Set in decimal.</li> <li>0: Main shaft clutch normal control</li> <li>1: Main shaft clutch forced OFF</li> </ul>	0	44082+20n

## [Cd.400] Main shaft clutch command

Set ON/OFF for the main shaft clutch command. This command is used when the clutch ON control mode is "1: Clutch command ON/OFF", "2: Clutch command leading edge" or "3: Clutch command trailing edge" and the clutch OFF control mode is "2: Clutch command leading edge" or "3: Clutch command trailing edge".

Status is considered as clutch command OFF just before starting synchronous control. If synchronous control is started while the clutch command is ON, the condition is established just after starting synchronous control, by setting "2: Clutch command leading edge". The condition is not established just after starting, by setting "3: Clutch command trailing edge".

## [Cd.401] Main shaft clutch control invalid command

The main shaft clutch control is invalid if "1" is set. The previous clutch ON/OFF status remains before clutch control becomes invalid.

Clutch control will not become invalid during the movement before clutch ON and clutch OFF. Instead, clutch control will become invalid after movement is completed.

## [Cd.402] Main shaft clutch forced OFF command

Set "1" to force the clutch OFF. The output value from the clutch becomes 0 immediately, even during clutch smoothing. The slippage (accumulative) amount is set to 0 if smoothing with a slippage method.

Reset to "0" to restart the clutch control from the clutch OFF status after using the clutch forced OFF command.

## 4.2 Auxiliary Shaft Module

### Overview of auxiliary shaft module

For the auxiliary shaft module, the input value is generated from the auxiliary shaft. The input value can be converted by the auxiliary shaft gear that provides the deceleration ratio and the rotation direction for the machine system, etc.

Refer to the following for details on setting for the auxiliary shaft module.

☞ Page 105 Auxiliary shaft parameters, ☞ Page 107 Auxiliary shaft clutch parameters

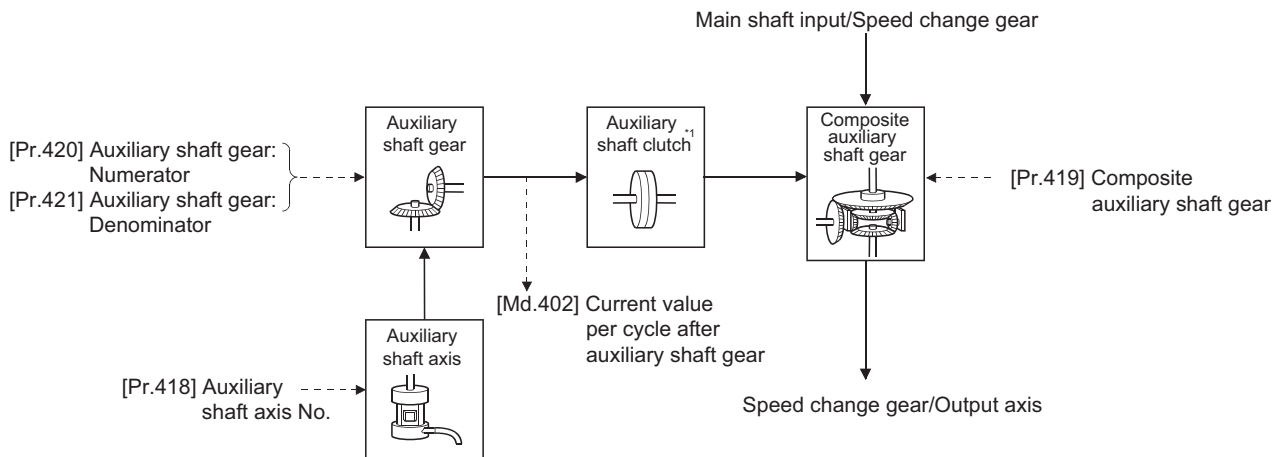

\*1 ☞ Page 113 Clutch

### Auxiliary shaft parameters

n: Axis No. - 1

Setting item	Setting details	Setting value	Default value	Buffer memory address
[Pr.418] Auxiliary shaft axis No.	<ul style="list-style-type: none"> <li>Set the input axis No. for the auxiliary shaft.</li> </ul> <u>Fetch cycle: At start of synchronous control</u>	<ul style="list-style-type: none"> <li>Set in decimal.</li> <li>0: Invalid</li> <li>1 to 8: Servo input axis<sup>*1</sup></li> <li>201 to 208: Command generation axis<sup>*1</sup></li> <li>801 to 804: Synchronous encoder axis</li> </ul>	0	36430+200n
[Pr.419] Composite auxiliary shaft gear	<ul style="list-style-type: none"> <li>Select the composite method for input values from the main shaft and the auxiliary shaft.</li> </ul> <u>Fetch cycle: Operation cycle</u>	<ul style="list-style-type: none"> <li>Set in hexadecimal.</li> </ul>	0001H	36431+200n
[Pr.420] Auxiliary shaft gear: Numerator	<ul style="list-style-type: none"> <li>Set the numerator for the auxiliary shaft gear.</li> </ul> <u>Fetch cycle: At start of synchronous control</u>	<ul style="list-style-type: none"> <li>Set in decimal.</li> <li>-2147483648 to 2147483647</li> </ul>	1	36432+200n 36433+200n
[Pr.421] Auxiliary shaft gear: Denominator	<ul style="list-style-type: none"> <li>Set the denominator for the auxiliary shaft gear.</li> </ul> <u>Fetch cycle: At start of synchronous control</u>	<ul style="list-style-type: none"> <li>Set in decimal.</li> <li>1 to 2147483647</li> </ul>	1	36434+200n 36435+200n

\*1 The range from axis 1 to 4 is valid in the 4-axis module and from axis 1 to 8 is valid in the 8-axis module.

## [Pr.418] Auxiliary shaft axis No.

Set the input axis No. for the auxiliary shaft.

Setting value	Details
0: Invalid	The input value is always 0.
1 to 8: Servo input axis	Set the servo input axis (axis 1 to axis 8). When the servo input axis is not set in the system setting, the input value is always 0. If the No. is set to the same value as the output axis, the error "Outside auxiliary shaft axis No. range" (error code: 1BF0H [FX5-SSC-S], or error code: 1E40H [FX5-SSC-G]) occurs and synchronous control cannot be started.
201 to 208: Command generation axis	Set the command generation axis (axis 1 to axis 8). When the command generation axis is invalid in the command generation axis parameter setting, the input value is always 0.
801 to 804: Synchronous encoder axis	Set the synchronous encoder axis (axis 1 to axis 4). When the synchronous encoder axis is invalid, the input value is always 0.

## [Pr.419] Composite auxiliary shaft gear

Set the composite method for input values from the main and auxiliary shafts. The setting values for each axis are shown as follows.

Setting value	Details
0: No input	The input value from the input axis is calculated as 0.
1: Input+	The input value from the input axis is calculated as it is.
2: Input-	The input value from the input axis is calculated with its opposite sign.

Operation assumes "0: No input" if the value is set out of the range from 0 to 2.

### Point

The composite method for the composite auxiliary shaft gear can be changed during synchronous control. It is used as a clutch to switch input values between the main and the auxiliary shafts.

## [Pr.420] Auxiliary shaft gear: Numerator, [Pr.421] Auxiliary shaft gear: Denominator

Set the numerator and the denominator for auxiliary shaft gear to convert the input value. The input value is converted as follows.

$$\text{Input value after conversion} = \text{Input value before conversion} \times \frac{[\text{Pr.420}] \text{ Auxiliary shaft gear: Numerator}}{[\text{Pr.421}] \text{ Auxiliary shaft gear: Denominator}}$$

The input value direction can be reversed by setting a negative value in the numerator of the auxiliary shaft gear.

Set the denominator of the auxiliary shaft gear to a value within the range from 1 to 2147483647.

# Auxiliary shaft clutch parameters

n: Axis No. - 1

Setting item	Setting details	Setting value	Default value	Buffer memory address
[Pr.422] Auxiliary shaft clutch control setting	<ul style="list-style-type: none"> <li>Set the control method for the clutch.</li> </ul> <u>Fetch cycle: Operation cycle</u>	<p>■Set in hexadecimal.</p> <p>ON control mode 0: No clutch 1: Clutch command ON/OFF 2: Clutch command leading edge 3: Clutch command trailing edge 4: Address mode 5: High speed input request</p> <p>OFF control mode 0: OFF control invalid 1: One-shot OFF 2: Clutch command leading edge 3: Clutch command trailing edge 4: Address mode 5: High speed input request</p> <p>High speed input request signal 0 to 7: High speed input request signal from axis 1 to axis 8<sup>*1</sup></p>	0000H	36436+200n
[Pr.423] Auxiliary shaft clutch reference address setting	<ul style="list-style-type: none"> <li>Set the reference address for the clutch.</li> </ul> <u>Fetch cycle: At start of synchronous control</u>	<p>■Set in decimal.</p> <p>0: Auxiliary shaft current value 1: Current value per cycle after auxiliary shaft gear</p>	0	36437+200n
[Pr.424] Auxiliary shaft clutch ON address	<ul style="list-style-type: none"> <li>Set the clutch ON address for address mode. (This setting is invalid except during address mode.)</li> <li>If the address is out of the range from 0 to (Cam axis length per cycle - 1), the address is converted to a value within range.</li> </ul> <u>Fetch cycle: Operation cycle</u>	<p>■Set in decimal.</p> <p>-2147483648 to 2147483647 [Auxiliary shaft position units<sup>*2</sup>, or cam axis cycle units<sup>*3</sup>]</p>	0	36438+200n 36439+200n
[Pr.425] Movement amount before auxiliary shaft clutch ON	<ul style="list-style-type: none"> <li>Set the movement amount between the clutch ON condition completing and the clutch closing.</li> <li>Set a positive value when the reference address is increasing, and a negative value when it is decreasing.</li> </ul> <u>Fetch cycle: At completing clutch ON condition</u>	<p>■Set in decimal.</p> <p>-2147483648 to 2147483647 [Auxiliary shaft position units<sup>*2</sup>, or cam axis cycle units<sup>*3</sup>]</p>	0	36440+200n 36441+200n
[Pr.426] Auxiliary shaft clutch OFF address	<ul style="list-style-type: none"> <li>Set the clutch OFF address for the address mode. (This setting is invalid except during address mode.)</li> <li>If the address is out of the range from 0 to (Cam axis length per cycle - 1), the setting address is converted to a value within range.</li> </ul> <u>Fetch cycle: Operation cycle</u>	<p>■Set in decimal.</p> <p>-2147483648 to 2147483647 [Auxiliary shaft position units<sup>*2</sup>, or cam axis cycle units<sup>*3</sup>]</p>	0	36442+200n 36443+200n
[Pr.427] Movement amount before auxiliary shaft clutch OFF	<ul style="list-style-type: none"> <li>Set the movement amount between the clutch OFF condition completing and the clutch opening.</li> <li>Set a positive value when the reference address is increasing, and a negative value when it is decreasing.</li> </ul> <u>Fetch cycle: At completing clutch OFF condition</u>	<p>■Set in decimal.</p> <p>-2147483648 to 2147483647 [Auxiliary shaft position units<sup>*2</sup>, or cam axis cycle units<sup>*3</sup>]</p>	0	36444+200n 36445+200n
[Pr.428] Auxiliary shaft clutch smoothing method	<ul style="list-style-type: none"> <li>Set the clutch smoothing method.</li> </ul> <u>Fetch cycle: At start of synchronous control</u>	<p>■Set in decimal.</p> <p>0: Direct 1: Time constant method (Exponent) 2: Time constant method (Linear) 3: Slippage method (Exponent) 4: Slippage method (Linear) 5: Slippage method (Linear: Input value follow up)</p>	0	36446+200n
[Pr.429] Auxiliary shaft clutch smoothing time constant	<ul style="list-style-type: none"> <li>For smoothing with a time constant method, set the smoothing time constant.</li> </ul> <u>Fetch cycle: At start of synchronous control</u>	<p>■Set in decimal.</p> <p>0 to 5000 [ms]</p>	0	36447+200n

Setting item	Setting details	Setting value	Default value	Buffer memory address
[Pr.430] Slippage amount at auxiliary shaft clutch ON	<ul style="list-style-type: none"> <li>For smoothing with a slippage method, set the slippage amount at clutch ON.</li> </ul> <u>Fetch cycle: At turning clutch ON</u>	<ul style="list-style-type: none"> <li>Set in decimal.</li> <li>0 to 2147483647</li> <li>[Auxiliary shaft position units<sup>*2</sup>, or cam axis cycle units<sup>*3</sup>]</li> </ul>	0	36448+200n 36449+200n
[Pr.431] Slippage amount at auxiliary shaft clutch OFF	<ul style="list-style-type: none"> <li>For smoothing with a slippage method, set the slippage amount at clutch OFF.</li> </ul> <u>Fetch cycle: At turning clutch OFF</u>	<ul style="list-style-type: none"> <li>Set in decimal.</li> <li>0 to 2147483647</li> <li>[Auxiliary shaft position units<sup>*2</sup>, or cam axis cycle units<sup>*3</sup>]</li> </ul>	0	36450+200n 36451+200n

\*1 The range from axis 1 to 4 is valid in the 4-axis module and from axis 1 to 8 is valid in the 8-axis module.

\*2 Auxiliary shaft position units (  Page 27 INPUT AXIS MODULE)

\*3 Cam axis cycle units (  Page 127 Units for the output axis)

## [Pr.422] Auxiliary shaft clutch control setting

Set the ON and OFF control methods separately for the auxiliary shaft.

The clutch control setting can be changed during synchronous control, however the setting to "No clutch" (Direct coupled operation) cannot be selected during synchronous control after already selecting another setting.

Refer to the following for operation details on the clutch control.

 Page 113 Control method for clutch

### ■ON control mode

Setting value	Details
0: No clutch (Direct coupled operation)	Execute direct coupled operation without clutch control.
1: Clutch command ON/OFF	The clutch is turned ON/OFF by the operation of "[Cd.403] Auxiliary shaft clutch command" ON/OFF. (Setting in the OFF control mode are not applicable in the clutch command ON/OFF mode.)
2: Clutch command leading edge	The clutch is turned ON when "[Cd.403] Auxiliary shaft clutch command" passes the leading edge (from OFF to ON).
3: Clutch command trailing edge	The clutch is turned ON when "[Cd.403] Auxiliary shaft clutch command" passes the trailing edge (from ON to OFF).
4: Address mode	The clutch is turned ON when the reference address (the auxiliary shaft current value or the current value per cycle after auxiliary shaft gear) reaches "[Pr.424] Auxiliary shaft clutch ON address". The movement amount after passing through the ON address is calculated as the output movement amount of the clutch based on the reference address passing through, thereby controlling the clutch with an accurate movement amount.
5: High speed input request	The clutch is turned ON when the high speed input request [DI] turns ON.

#### Point

Other clutch parameters are not applicable during direct coupled operation by setting "0: No clutch". "[Cd.405] Auxiliary shaft clutch forced OFF command" and the change of the clutch control setting are ignored during direct coupled operation.

### ■OFF control mode

Setting value	Details
0: OFF control invalid	Clutch OFF control is not used. This setting is applicable only for execution with clutch ON control.
1: One-shot OFF	The clutch is turned OFF after moving the distance "[Pr.427] Movement amount before auxiliary shaft clutch OFF" (One-shot operation) after the clutch command turns ON. If "[Pr.427] Movement amount before auxiliary shaft clutch OFF" is 0, "[Md.423] Auxiliary shaft clutch ON/OFF status" does not turn ON in order to turn back OFF immediately.
2: Clutch command leading edge	The clutch is turned OFF when "[Cd.403] Auxiliary shaft clutch command" passes the leading edge (from OFF to ON).
3: Clutch command trailing edge	The clutch is turned OFF when "[Cd.403] Auxiliary shaft clutch command" passes the trailing edge (from ON to OFF).
4: Address mode	The clutch is turned OFF when the reference address (the auxiliary shaft current value or the current value per cycle after auxiliary shaft gear) reaches "[Pr.426] Auxiliary shaft clutch OFF address". The movement amount before passing through the OFF address is calculated as the output movement amount of the clutch based on the reference address passing through, thereby controlling the clutch with an accurate movement amount.
5: High speed input request	The clutch is turned OFF when the high speed input request [DI] turns ON.

### ■High speed input request signal

Set the high speed input request signal No. for the ON control mode (1) and the OFF control mode (2) when using the setting "5: High speed input request".

Signal No.	Setting value (Hexadecimal)	Signal No.	Setting value (Hexadecimal)
1	0	5	4
2	1	6	5
3	2	7	6
4	3	8	7

### [Pr.423] Auxiliary shaft clutch reference address setting

Select the address type to be used as the reference address for clutch control. Note that the processing order of the auxiliary shaft gear and the auxiliary shaft clutch will change depending on the reference address setting.

Setting value	Details
0: Auxiliary shaft current value	The clutch is controlled by using the current value for the servo input axis/synchronous encoder axis that is set for the auxiliary shaft. Output after the clutch is a converted movement amount through the auxiliary shaft gear.
1: Current value per cycle after auxiliary shaft gear	The clutch is controlled by using the current value per cycle after auxiliary shaft gear. Output after the clutch is a movement amount without conversion.

The setting values for the following parameters are in units based on the reference address setting.

- "[Pr.424] Auxiliary shaft clutch ON address"
- "[Pr.426] Auxiliary shaft clutch OFF address"
- "[Pr.425] Movement amount before auxiliary shaft clutch ON", "[Pr.427] Movement amount before auxiliary shaft clutch OFF"
- "[Pr.430] Slippage amount at auxiliary shaft clutch ON", "[Pr.431] Slippage amount at auxiliary shaft clutch OFF"

### [Pr.424] Auxiliary shaft clutch ON address

Set the clutch ON address when address mode is configured for the ON control mode of the auxiliary shaft clutch. When the reference address is the current value per cycle after auxiliary shaft gear, the setting address is converted for control within the range from 0 to (Cam axis length per cycle - 1).

**Ex.**

Cam axis length per cycle: 20000 pulses

The ON address is controlled as 19000 pulses when the setting value is "-1000".

### [Pr.425] Movement amount before auxiliary shaft clutch ON

Set the movement amount of the reference address with a signed value between the clutch ON condition completing and the clutch closing.

Setting value	Details
1 to 2147483647 (Positive value)	Used when the reference address is increasing in direction.
0	No movement amount (The clutch is immediately turned ON with the clutch ON condition completing.)
-2147483648 to -1 (Negative value)	Used when the reference address is decreasing in direction.

Clutch ON condition is completed (Example: [Cd.403] Auxiliary shaft clutch command ON)

[Md.423] Auxiliary shaft clutch ON/OFF status

Auxiliary shaft current value or [Md.402] Current value per cycle after auxiliary shaft gear

Movement amount after clutch

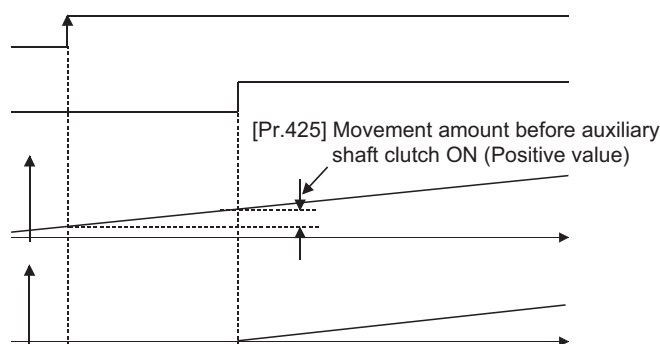

## [Pr.426] Auxiliary shaft clutch OFF address

Set the clutch OFF address when address mode is configured for the OFF control mode of the auxiliary shaft clutch. When the reference address is the current value per cycle after auxiliary shaft gear, the setting address is converted for control within the range from 0 to (Cam axis length per cycle - 1).

**Ex.**

Cam axis length per cycle: 20000 pulses

The OFF address is controlled as 60 pulses when the setting value is "40060".

## [Pr.427] Movement amount before auxiliary shaft clutch OFF

Set the movement amount of the reference address with a signed value between the clutch OFF condition completing and the clutch opening.

Setting value	Details
1 to 2147483647 (Positive value)	Used when the reference address is increasing in direction.
0	No movement amount (The clutch is immediately turned OFF with the clutch OFF condition completing.)
-2147483648 to -1 (Negative value)	Used when the reference address is decreasing in direction.

Clutch OFF condition is completed  
(Example: [Cd.403] Auxiliary shaft clutch command OFF)

[Md.423] Auxiliary shaft clutch ON/OFF status

Auxiliary shaft current value or [Md.402] Current value per cycle after auxiliary shaft gear

Movement amount after clutch

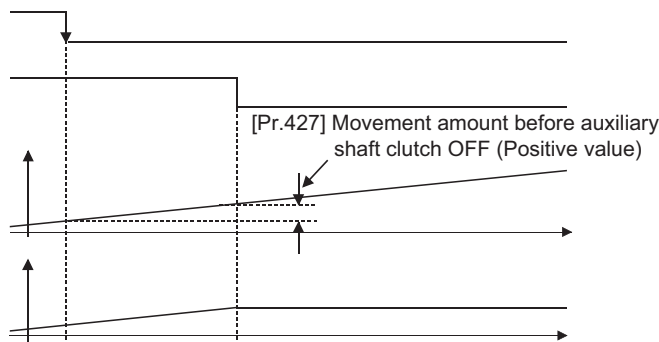

## [Pr.428] Auxiliary shaft clutch smoothing method

Set the smoothing method for clutch ON/OFF.

Refer to the following.

☞ Page 118 Smoothing method for clutch

Setting value	Details
0: Direct	No smoothing.
1: Time constant method (Exponent)	Smoothing with an exponential curve based on the time constant setting.
2: Time constant method (Linear)	Smoothing with linear acceleration/deceleration based on the time constant setting.
3: Slippage method (Exponent)	Smoothing with an exponential curve based on the slippage amount setting.
4: Slippage method (Linear)	Smoothing with linear acceleration/deceleration based on the slippage amount setting.
5: Slippage method (Linear: Input value follow up)	Smoothing with linear acceleration/deceleration based on the slippage amount setting (input value follow up).

## [Pr.429] Auxiliary shaft clutch smoothing time constant

Set a time constant when the time constant method is set in "[Pr.428] Auxiliary shaft clutch smoothing method".

The time constant setting applies for clutch ON/OFF.



### **[Pr.430] Slippage amount at auxiliary shaft clutch ON**

Set the slippage amount at clutch ON when the slippage method is set in "[Pr.428] Auxiliary shaft clutch smoothing method". The slippage amount is set in units based on the current value selected in "[Pr.423] Auxiliary shaft clutch reference address setting".

If the set amount is negative, the slippage amount at clutch ON is controlled as 0 (direct).

### **[Pr.431] Slippage amount at auxiliary shaft clutch OFF**

Set the slippage amount at clutch OFF when the slippage method is set in "[Pr.428] Auxiliary shaft clutch smoothing method". The slippage amount is set in units based on the current value selected in "[Pr.423] Auxiliary shaft clutch reference address setting".

If the set amount is negative, the slippage amount at clutch OFF is controlled as 0 (direct).

# Auxiliary shaft clutch control data

n: Axis No. - 1

Setting item	Setting details	Setting value	Default value	Buffer memory address
[Cd.403] Auxiliary shaft clutch command	<ul style="list-style-type: none"> <li>Set the clutch command ON/OFF.</li> </ul> <u>Fetch cycle: Operation cycle</u>	<ul style="list-style-type: none"> <li>Set in decimal.</li> <li>0: Auxiliary shaft clutch command OFF</li> <li>1: Auxiliary shaft clutch command ON</li> </ul>	0	44083+20n
[Cd.404] Auxiliary shaft clutch control invalid command	<ul style="list-style-type: none"> <li>Set "1" to disable the clutch control temporarily.</li> </ul> <u>Fetch cycle: Operation cycle</u>	<ul style="list-style-type: none"> <li>Set in decimal.</li> <li>0: Auxiliary shaft clutch control valid</li> <li>1: Auxiliary shaft clutch control invalid</li> </ul>	0	44084+20n
[Cd.405] Auxiliary shaft clutch forced OFF command	<ul style="list-style-type: none"> <li>Set "1" to force the clutch OFF.</li> </ul> <u>Fetch cycle: Operation cycle</u>	<ul style="list-style-type: none"> <li>Set in decimal.</li> <li>0: Auxiliary shaft clutch normal control</li> <li>1: Auxiliary shaft clutch forced OFF</li> </ul>	0	44085+20n

## [Cd.403] Auxiliary shaft clutch command

Set ON/OFF for the auxiliary shaft clutch command. This command is used when the clutch ON control mode is "1: Clutch command ON/OFF", "2: Clutch command leading edge" or "3: Clutch command trailing edge" and the clutch OFF control mode is "2: Clutch command leading edge" or "3: Clutch command trailing edge".

Status is considered as clutch command OFF just before starting synchronous control. If synchronous control is started while the clutch command is ON, the condition is established just after starting synchronous control, by setting "2: Clutch command leading edge". The condition is not established after starting, by setting "3: Clutch command trailing edge."

## [Cd.404] Auxiliary shaft clutch control invalid command

The auxiliary shaft clutch control is invalid if "1" is set. The previous clutch ON/OFF status remains before clutch control becomes invalid.

Clutch control will not become invalid during the movement before clutch ON and clutch OFF. Instead, clutch control will become invalid after the movement is completed.

## [Cd.405] Auxiliary shaft clutch forced OFF command

Set "1" to force the clutch OFF. The output value from the clutch becomes 0 immediately, even during clutch smoothing. The slippage (accumulative) amount is set to 0 if smoothing with a slippage method.

Reset to "0" to restart the clutch control from the clutch OFF status after using the clutch forced OFF command.

# 4.3 Clutch

## Overview of clutch

The clutch is used to transmit/disengage command pulses from the main/auxiliary shaft input side to the output axis module through turning the clutch ON/OFF, which controls the operation/stop of the servomotor.

A clutch can be configured for the main and auxiliary shafts.

## Control method for clutch

Set the ON and OFF control methods separately in "[Pr.405] Main shaft clutch control setting" and "[Pr.422] Auxiliary shaft clutch control setting".

The clutch control setting can be changed during synchronous control, however, the setting "No clutch" (Direct coupled operation) cannot be selected during synchronous control after already selecting another setting.

Item	Setting item		Setting details/Setting value
	Main shaft clutch	Auxiliary shaft clutch	
Clutch control setting	[Pr.405] Main shaft clutch control setting	[Pr.422] Auxiliary shaft clutch control setting	<ul style="list-style-type: none"> <li>• Set the clutch control method.</li> <li>■ Set in hexadecimal.</li> </ul> <div style="margin-left: 20px;"> <p>H</p> <ul style="list-style-type: none"> <li>→ ON control mode               <ul style="list-style-type: none"> <li>0: No clutch</li> <li>1: Clutch command ON/OFF</li> <li>2: Clutch command leading edge</li> <li>3: Clutch command trailing edge</li> <li>4: Address mode</li> <li>5: High speed input request</li> </ul> </li> <li>→ OFF control mode               <ul style="list-style-type: none"> <li>0: OFF control invalid</li> <li>1: One-shot OFF</li> <li>2: Clutch command leading edge</li> <li>3: Clutch command trailing edge</li> <li>4: Address mode</li> <li>5: High speed input request</li> </ul> </li> <li>→ High speed input request signal               <ul style="list-style-type: none"> <li>0 to 7: High speed input request signal from axis 1 to axis 8<sup>*1</sup></li> </ul> </li> </ul> </div>

\*1 The range from axis 1 to 4 is valid in the 4-axis module and from axis 1 to 8 is valid in the 8-axis module. When the clutch ON condition and the clutch OFF condition are completed simultaneously within one operation cycle, both clutch ON and OFF processing are executed within one operation cycle. Therefore, the clutch is from OFF to ON and again to OFF at the clutch OFF status, and it is from ON to OFF and again to ON at the clutch ON status. The following shows the operations for the clutch ON/OFF by the setting of the ON control mode and the OFF control mode.

### ON control mode

#### ■ No clutch (Direct coupled operation)

Execute direct coupled operation without clutch control.



Other clutch parameters are not applicable during direct coupled operation by setting "0: No clutch". "Clutch forced OFF command" and the change of the clutch control setting are ignored during direct coupled operation.

### ■Clutch command ON/OFF

The clutch is turned ON/OFF by the operation of clutch command ON/OFF.  
(Setting in the OFF control mode are not applicable in this mode.)

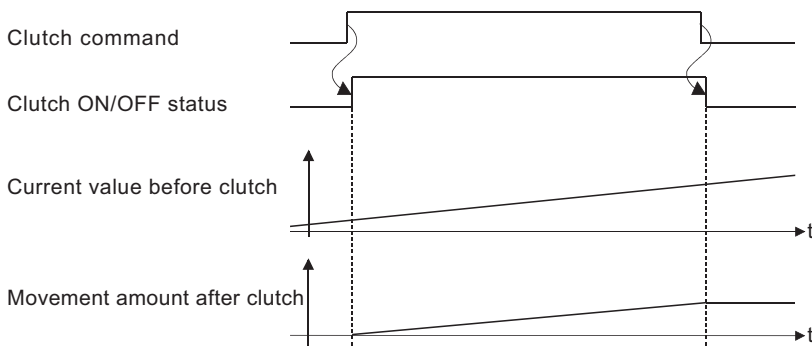

Item	Main shaft clutch	Auxiliary shaft clutch
Clutch command	[Cd.400] Main shaft clutch command	[Cd.403] Auxiliary shaft clutch command
Clutch ON/OFF status	[Md.420] Main shaft clutch ON/OFF status	[Md.423] Auxiliary shaft clutch ON/OFF status

### ■Clutch command leading edge

The clutch is turned ON when the clutch command passes the leading edge (from OFF to ON).

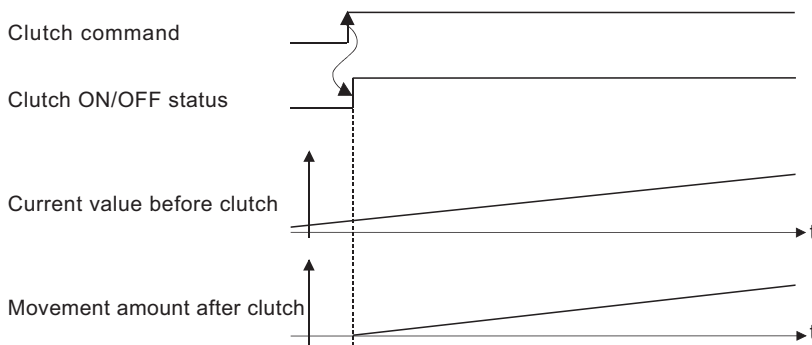

### ■Clutch command trailing edge

The clutch is turned ON when the clutch command passes the trailing edge (from ON to OFF).

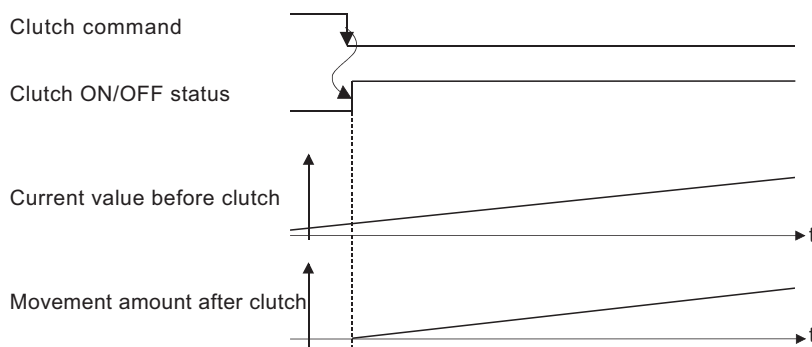

## ■Address mode

The clutch is turned ON when the reference address reaches "Clutch ON address".

The movement amount after passing through the ON address is calculated as the output movement amount of the clutch based on the reference address passing through, thereby controlling the clutch with an accurate movement amount.

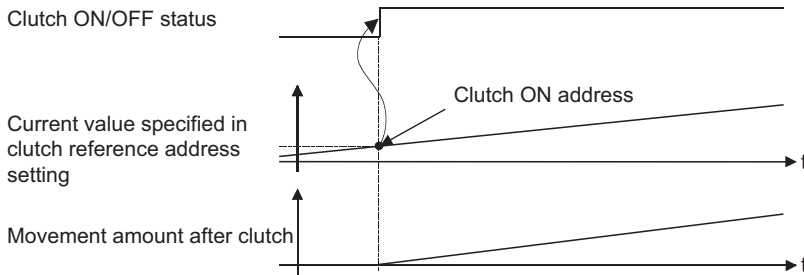

Item	Main shaft clutch	Auxiliary shaft clutch
Reference address	The current value specified in "[Pr.406] Main shaft clutch reference address setting" ("[Md.400] Current value after composite main shaft gear" or "[Md.401] Current value per cycle after main shaft gear")	The current value specified in "[Pr.423] Auxiliary shaft clutch reference address setting" (Auxiliary shaft current value (servo input axis current value/synchronous encoder axis current value) or "[Md.402] Current value per cycle after auxiliary shaft gear")
Clutch ON address	[Pr.407] Main shaft clutch ON address	[Pr.424] Auxiliary shaft clutch ON address
Clutch ON/OFF status	[Md.420] Main shaft clutch ON/OFF status	[Md.423] Auxiliary shaft clutch ON/OFF status

## ■High speed input request

The clutch is turned ON when the high speed input request [DI] turns ON.

The following actions are required when using the high speed input request.

- Set the signal No. for the "High speed input request signal" clutch control setting
- Set the external command signal used in "[Pr.95] External command signal selection", "4: High speed input request" in "[Pr.42] External command function selection" and "1: Validates an external command" in "[Cd.8] External command valid" for the applicable axis.

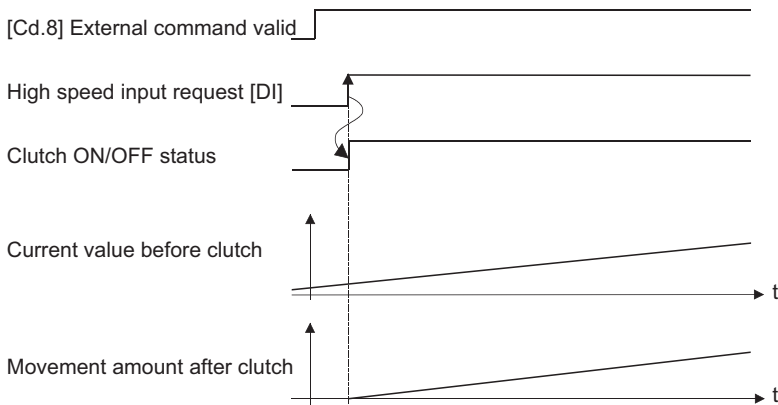

## OFF control mode

### ■OFF control invalid

Clutch OFF control is not used. This setting is applicable only for execution with clutch ON control.

### ■One-shot OFF

The clutch is turned OFF after moving the distance "Movement amount before clutch OFF" (One-shot operation) after the clutch command turn ON.

If "Movement amount before clutch OFF" is 0, "Clutch ON/OFF status" does not turn ON in order to turn back OFF immediately.

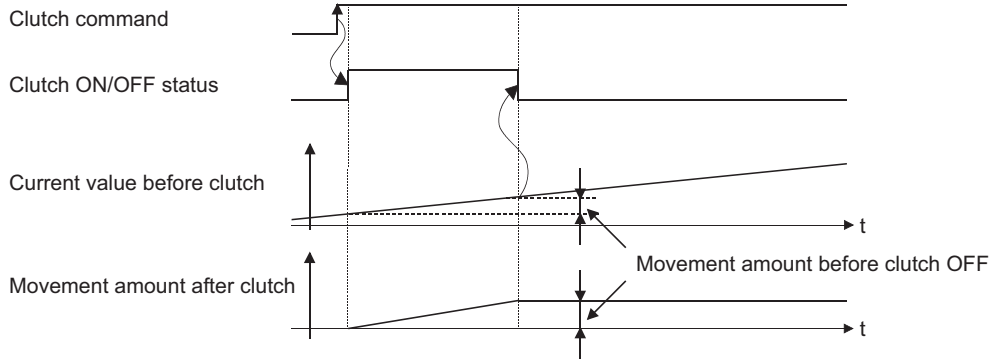

Item	Main shaft clutch	Auxiliary shaft clutch
Clutch command	[Cd.400] Main shaft clutch command	[Cd.403] Auxiliary shaft clutch command
Clutch ON/OFF status	[Md.420] Main shaft clutch ON/OFF status	[Md.423] Auxiliary shaft clutch ON/OFF status
Movement amount before clutch OFF	[Pr.410] Movement amount before main shaft clutch OFF	[Pr.427] Movement amount before auxiliary shaft clutch OFF

### ■Clutch command leading edge

The clutch is turned OFF when the clutch command passes the leading edge (from OFF to ON).

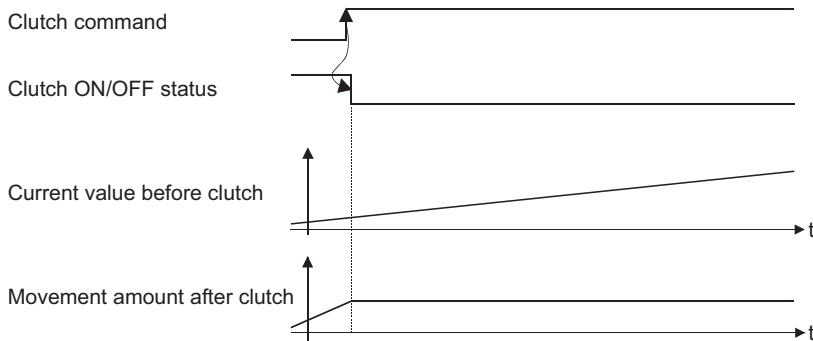

### ■Clutch command trailing edge

The clutch is turned OFF when the clutch command passes the trailing edge (from ON to OFF).

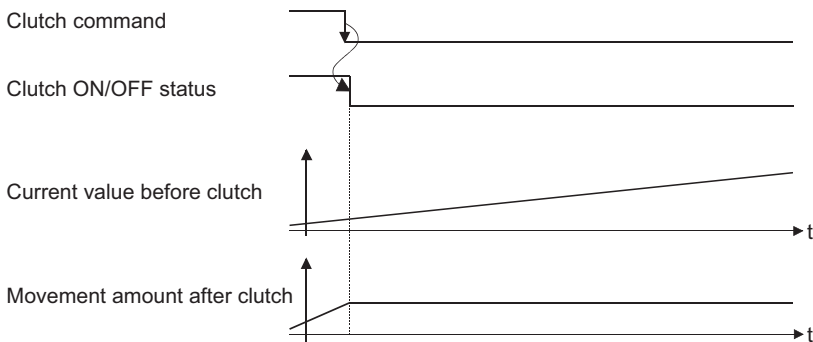

## ■Address mode

The clutch is turned OFF when the reference address reaches "Clutch OFF address".

The movement amount before passing through the OFF address is calculated as the output movement amount of the clutch based on the reference address passing through, thereby controlling the clutch with an accurate movement amount.

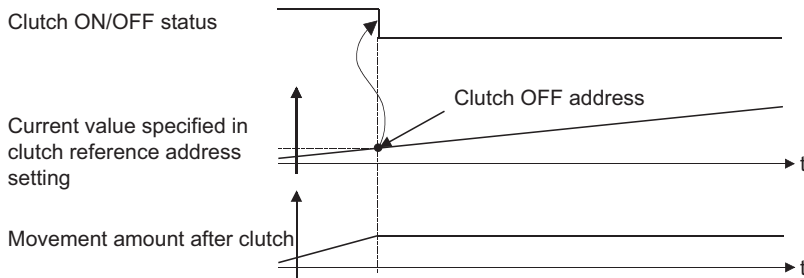

Item	Main shaft clutch	Auxiliary shaft clutch
Reference address	The current value specified in "[Pr.406] Main shaft clutch reference address setting" ("[Md.400] Current value after composite main shaft gear" or "[Md.401] Current value per cycle after main shaft gear")	The current value specified in "[Pr.423] Auxiliary shaft clutch reference address setting" (Auxiliary shaft current value (servo input axis current value/synchronous encoder axis current value) or "[Md.402] Current value per cycle after auxiliary shaft gear")
Clutch OFF address	[Pr.409] Main shaft clutch OFF address	[Pr.426] Auxiliary shaft clutch OFF address
Clutch ON/OFF status	[Md.420] Main shaft clutch ON/OFF status	[Md.423] Auxiliary shaft clutch ON/OFF status

## ■High speed input request

The clutch is turned OFF when the high speed input request [DI] turns ON.

The following actions are required when using the high speed input request.

- Set the signal No. for the "High speed input request signal" clutch control setting.
- Set the external command signal used in "[Pr.95] External command signal selection", "4: High speed input request" in "[Pr.42] External command function selection" and "1: Validates an external command" in "[Cd.8] External command valid" for the applicable axis.

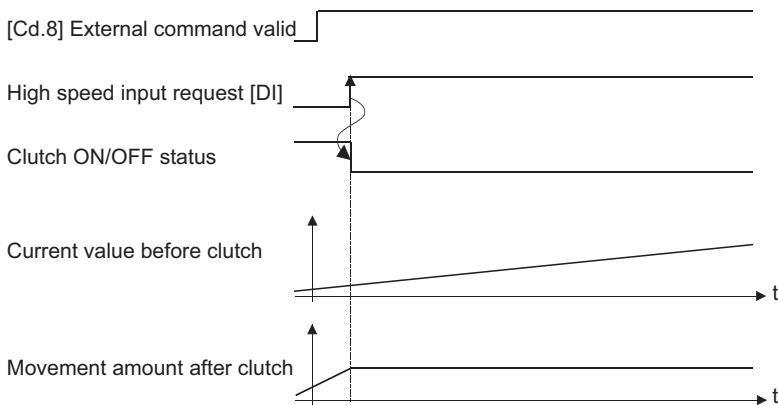

# Smoothing method for clutch

Set the clutch smoothing method in "[Pr.411] Main shaft clutch smoothing method" and "[Pr.428] Auxiliary shaft clutch smoothing method".

The 2 types of clutch smoothing include the following.

- Time constant method smoothing
- Slippage method smoothing

When not using clutch smoothing, set "0: Direct" in the clutch smoothing method.

Item	Setting item		Setting details/Setting value
	Main shaft clutch	Auxiliary shaft clutch	
Clutch smoothing method	[Pr.411] Main shaft clutch smoothing method	[Pr.428] Auxiliary shaft clutch smoothing method	<ul style="list-style-type: none"> <li>• Set the clutch smoothing method.</li> <li>■Set in decimal.</li> <li>0: Direct</li> <li>1: Time constant method (Exponent)</li> <li>2: Time constant method (Linear)</li> <li>3: Slippage method (Exponent)</li> <li>4: Slippage method (Linear)</li> <li>5: Slippage method (Linear: Input value follow up)</li> </ul>

The operation of each smoothing method is shown below.

## Time constant method smoothing

Smoothing is processed with the time constant setting value in the smoothing time constant at clutch ON/OFF. After clutch ON smoothing is complete, smoothing is processed with the time constant setting value when the speed of the input values changes.

The movement amount between the clutch turning ON and OFF is not changed with smoothing.

Movement amount after clutch smoothing = Movement amount before clutch smoothing

Item	Setting item		Setting details	Setting value
	Main shaft clutch	Auxiliary shaft clutch		
Clutch smoothing time constant	[Pr.412] Main shaft clutch smoothing time constant	[Pr.429] Auxiliary shaft clutch smoothing time constant	<ul style="list-style-type: none"> <li>• For smoothing with a time constant method, set the smoothing time constant.</li> </ul>	<ul style="list-style-type: none"> <li>■Set in decimal.</li> <li>0 to 5000 [ms]</li> </ul>

## ■Time constant method exponential curve smoothing

Set "1: Time constant method (Exponential)" in the clutch smoothing method.

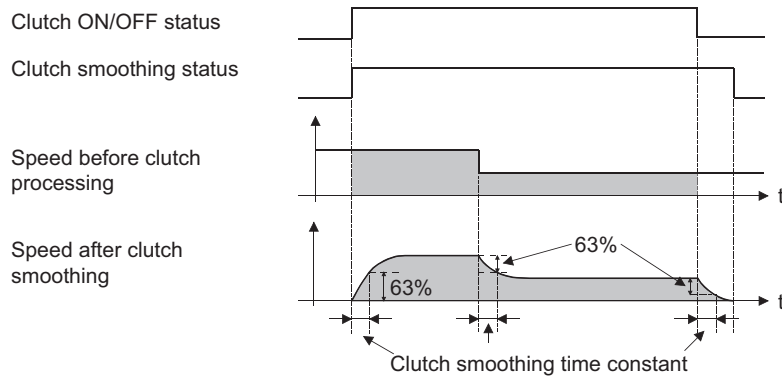

Item	Main shaft clutch	Auxiliary shaft clutch
Clutch ON/OFF status	[Md.420] Main shaft clutch ON/OFF status	[Md.423] Auxiliary shaft clutch ON/OFF status
Clutch smoothing status	[Md.421] Main shaft clutch smoothing status	[Md.424] Auxiliary shaft clutch smoothing status



### Time constant method linear acceleration/deceleration smoothing

Set "2: Time constant method (Linear)" in the clutch smoothing method.

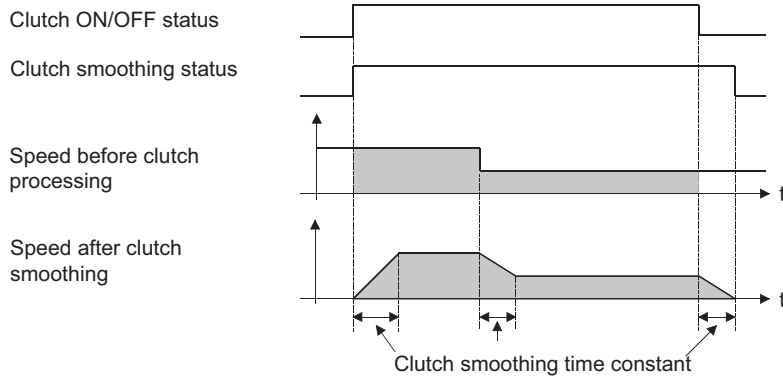

### Slippage method smoothing

Smoothing is processed with the value in slippage at clutch ON when the clutch turns ON, and with slippage at clutch OFF when the clutch turns OFF.

Smoothing is also processed with the slippage amount setting when the input speed to the clutch changes, therefore, positioning control at clutch ON/OFF is not affected by speed changes.

Processing proceeds with direct operation after completing clutch ON smoothing.

The movement amount between the clutch turning ON and OFF is as follows after clutch smoothing.

Movement amount after clutch smoothing = Movement amount before clutch smoothing + (Slippage amount at OFF - Slippage amount at ON)

Item	Setting item		Setting details	Setting value
	Main shaft clutch	Auxiliary shaft clutch		
Slippage amount at clutch ON	[Pr.413] Slippage amount at main shaft clutch ON	[Pr.430] Slippage amount at auxiliary shaft clutch ON	For smoothing with a slippage method, set the slippage amount at clutch ON.	■Set in decimal. 0 to 2147483647 [Main input axis position units <sup>*1</sup> / auxiliary shaft position units <sup>*2</sup> or cam axis cycle units <sup>*3</sup> ]
Slippage amount at clutch OFF	[Pr.414] Slippage amount at main shaft clutch OFF	[Pr.431] Slippage amount at auxiliary shaft clutch OFF	For smoothing with a slippage method, set the slippage amount at clutch OFF.	

\*1 Main input axis position units (☞ Page 27 INPUT AXIS MODULE)

\*2 Auxiliary shaft position units (☞ Page 27 INPUT AXIS MODULE)

\*3 Cam axis cycle units (☞ Page 127 Units for the output axis)

### Slippage method exponential curve smoothing

Set "3: Slippage (Exponential)" in the clutch smoothing method.

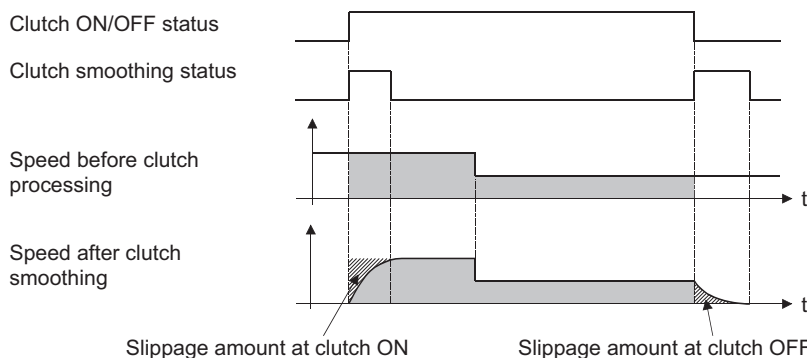

Item	Main shaft clutch	Auxiliary shaft clutch
Clutch ON/OFF status	[Md.420] Main shaft clutch ON/OFF status	[Md.423] Auxiliary shaft clutch ON/OFF status
Clutch smoothing status	[Md.421] Main shaft clutch smoothing status	[Md.424] Auxiliary shaft clutch smoothing status

## ■Slippage method linear acceleration/deceleration smoothing

Set "4: Slippage method (Linear)" or "5: Slippage method (Linear: Input value follow up)" in the clutch smoothing method. The differences between "4: Slippage method (Linear)" and "5: Slippage method (Linear: Input value follow up)" are shown below.

Input speed during smoothing	Smoothing method	
	4: Slippage method (Linear)	5: Slippage method (Linear: Input value follow up)
When the speed is fixed	No differences	
When the speed is changed continuously and slightly	Smoothing section is changed.	Smoothing section is fixed.
When the speed is changed largely	The output speed is changed slightly. (The average speed might be faster than the speed before starting smoothing.)	The output speed is changed depending on the input speed. (When the input speed is decelerated and accelerated again, the speed might be accelerated rapidly.)

- When the input speed to the clutch is fixed

The operations of "4: Slippage method (Linear)" and "5: Slippage method (Linear: Input value follow up)" are same.

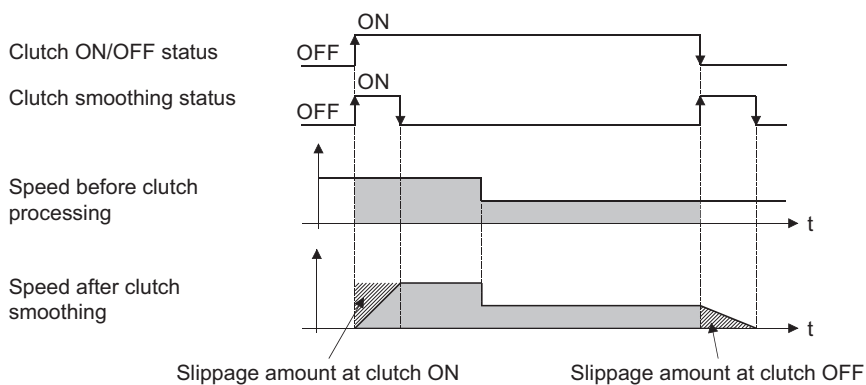

- When the input speed to the clutch is changed continuously and slightly

["4: Slippage method (Linear)" is set.]

The clutch smoothing status ON section is changed.

When the clutch smoothing status ON section is extended

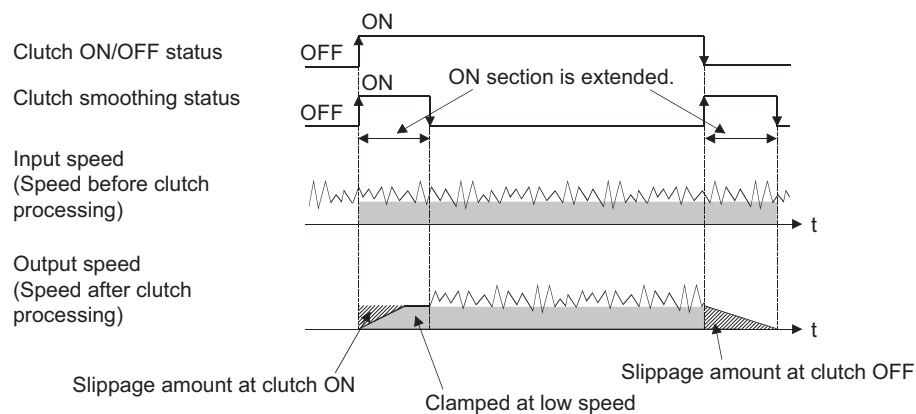

When the clutch smoothing status ON section is shortened

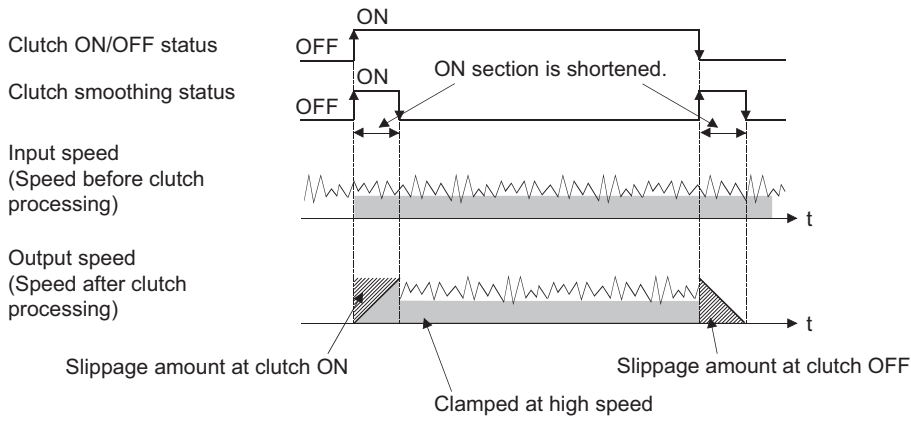

["5: Slippage method (Linear: Input value follow up)" is set.]

The clutch smoothing status ON section is fixed.

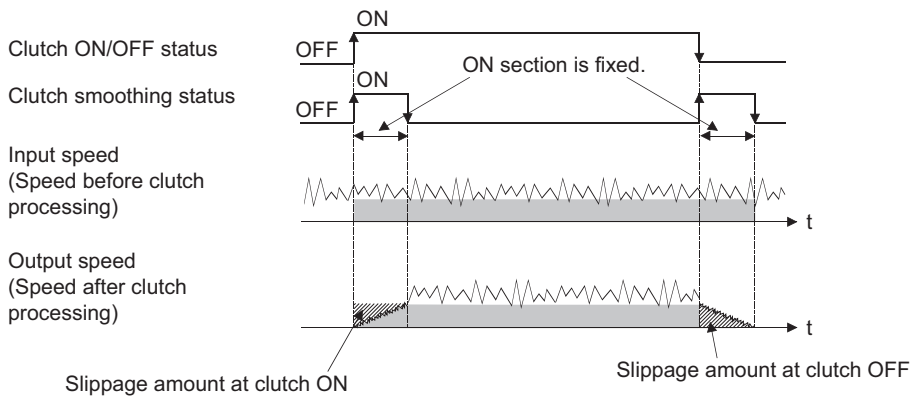

- When the input speed is changed largely during smoothing

["4: Slippage method (Linear)" is set.]

The output speed is changed slightly compared to the change of the input speed.

(The average speed might be faster than the speed before starting smoothing.)

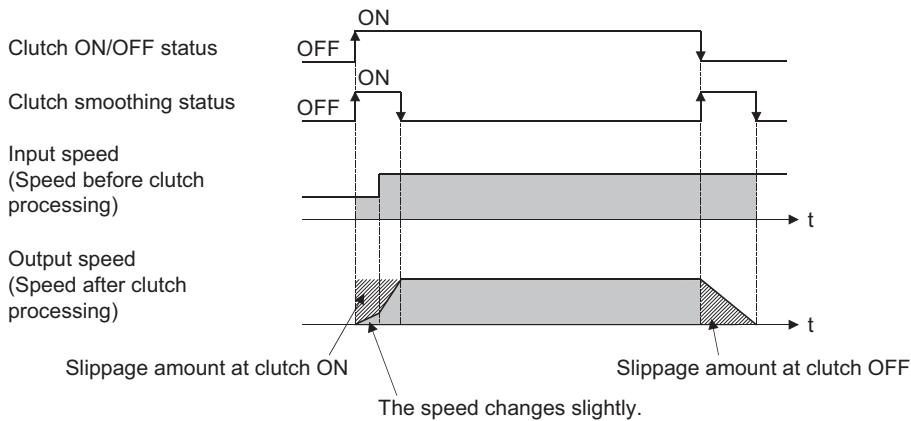

["5: Slippage method (Linear: Input value follow up)" is set.]

The output speed is changed depending on the input speed.

(When the input speed is decelerated and accelerated again, the speed might be accelerated rapidly.)

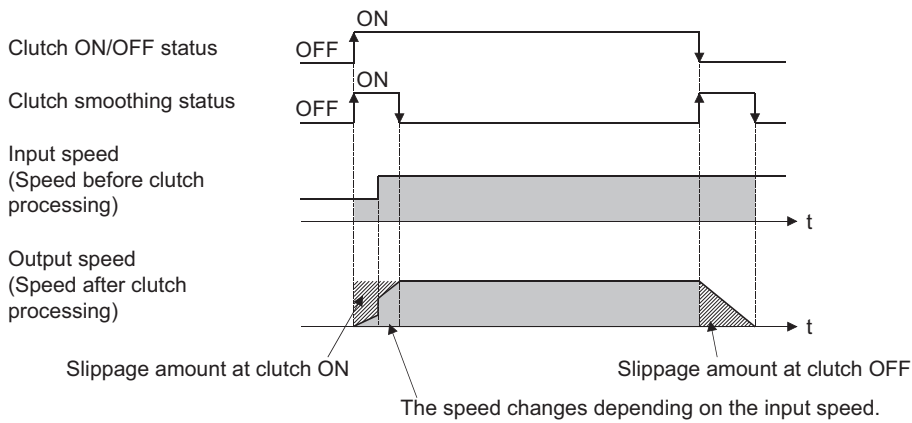

### ■ Operation at input speed deceleration during slippage method smoothing

When the speed before clutch processing decreases, the speed after clutch smoothing is controlled without exceeding the speed before clutch processing.

If slippage amount remains when the speed before clutch processing becomes 0, the smoothing process will be continued.

Then, the clutch smoothing process will be executed with the remaining slippage amount when the speed before clutch processing gets faster than the speed after clutch smoothing.

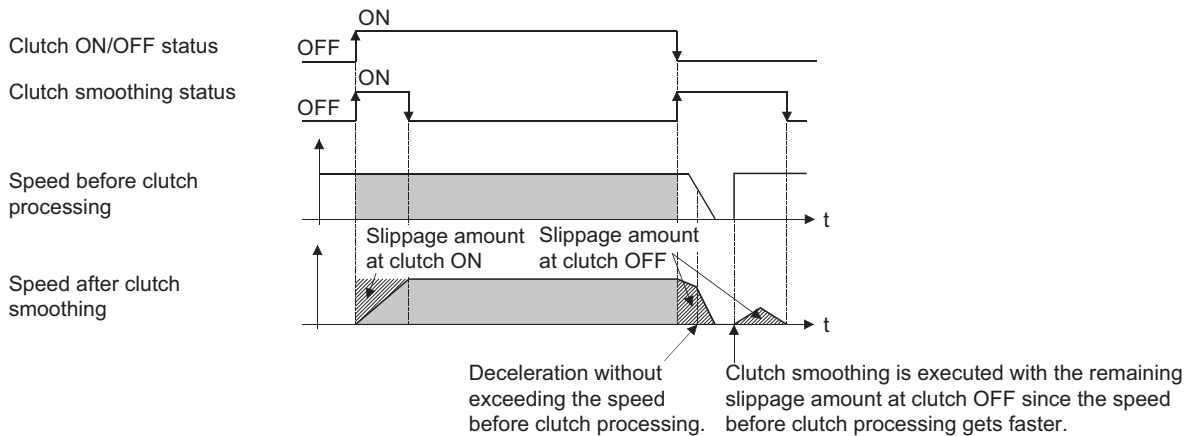

# Use example of clutch

The following machine shows an example using clutch control for a flying shear cutting system that synchronizes off a start signal from a sensor input.

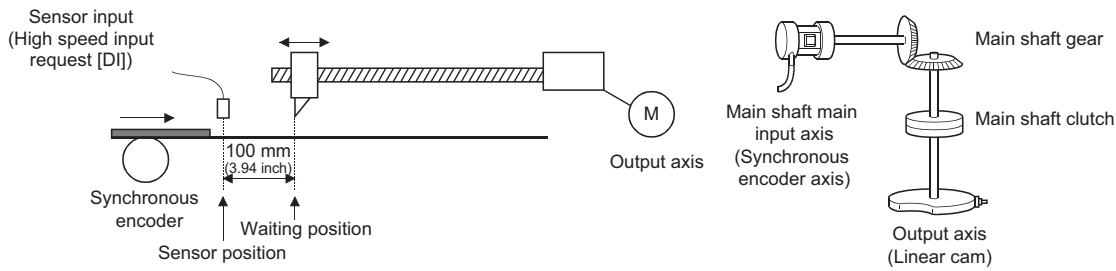

Main shaft clutch setting item	Setting value	
[Pr.405] Main shaft clutch control setting	ON control mode	5: High speed input request
	OFF control mode	1: One-shot OFF
	High speed input request signal	(Specify the high speed input request signal No., used for sensor input.)
[Pr.406] Main shaft clutch reference address setting	0: Current value after composite main shaft gear	
[Pr.408] Movement amount before main shaft clutch ON	0 mm	
[Pr.410] Movement amount before main shaft clutch OFF	380 mm (14.96 inch)	
[Pr.411] Main shaft clutch smoothing method	4: Slippage method (Linear)	
[Pr.413] Slippage amount at main shaft clutch ON	100 mm (3.94 inch) (Distance between the sensor and the waiting position)	
[Pr.414] Slippage amount at main shaft clutch OFF	20 mm (0.79 inch)	

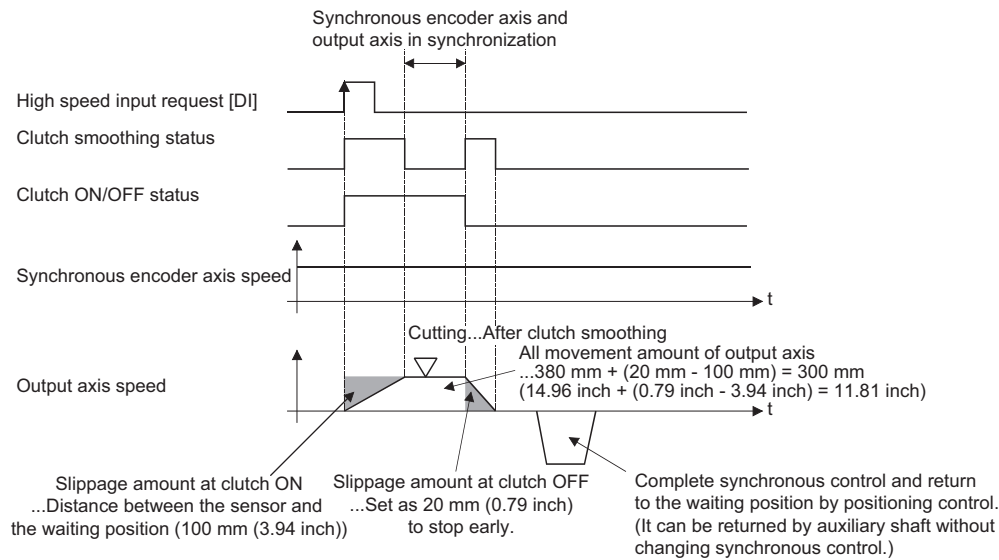

# 4.4 Speed Change Gear Module

## Overview of speed change gear module

A speed change gear module is used to change the input speed from the main shaft/auxiliary shaft/composite auxiliary shaft gear during operation. When not using a speed change gear module, set "0: No speed change gear" in "[Pr.434] Speed change gear".

With speed change from a speed change gear module, operation is executed with linear acceleration/deceleration based on the setting for the speed change gear smoothing time constant.

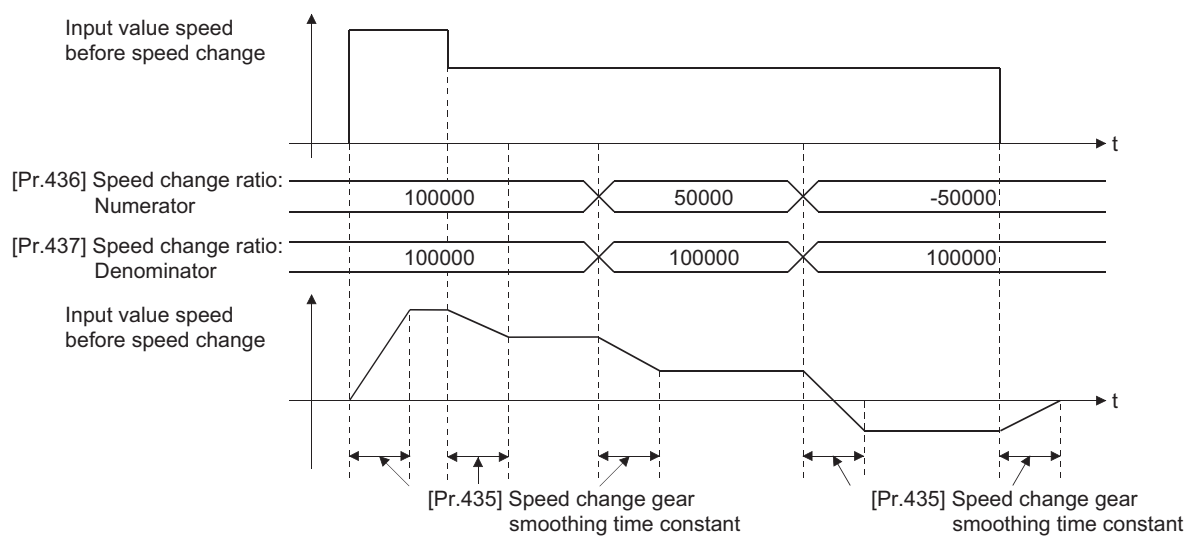
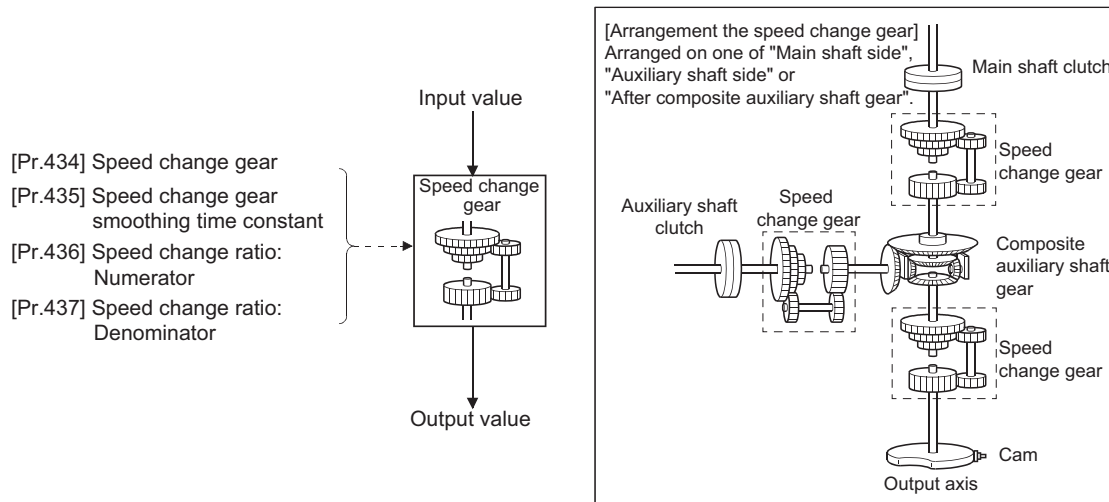

# Speed change gear parameters

n: Axis No. - 1

Setting item	Setting details	Setting value	Default value	Buffer memory address
[Pr.434] Speed change gear	<ul style="list-style-type: none"> <li>Set the arrangement for the speed change gear.</li> </ul> <u>Fetch cycle: At start of synchronous control</u>	<ul style="list-style-type: none"> <li>Set in decimal.</li> <li>0: No speed change gear</li> <li>1: Main shaft side</li> <li>2: Auxiliary shaft side</li> <li>3: After composite auxiliary shaft gear</li> </ul>	0	36460+200n
[Pr.435] Speed change gear smoothing time constant	<ul style="list-style-type: none"> <li>Set the smoothing time constant for the speed change gear.</li> </ul> <u>Fetch cycle: At start of synchronous control</u>	<ul style="list-style-type: none"> <li>Set in decimal.</li> <li>0 to 5000 [ms]</li> </ul>	0	36461+200n
[Pr.436] Speed change ratio: Numerator	<ul style="list-style-type: none"> <li>Set the numerator for the speed change ratio.</li> </ul> <u>Fetch cycle: Operation cycle</u>	<ul style="list-style-type: none"> <li>Set in decimal.</li> <li>-2147483648 to 2147483647</li> </ul>	1	36462+200n 36463+200n
[Pr.437] Speed change ratio: Denominator	<ul style="list-style-type: none"> <li>Set the denominator for the speed change ratio.</li> </ul> <u>Fetch cycle: Operation cycle</u>	<ul style="list-style-type: none"> <li>Set in decimal.</li> <li>1 to 2147483647</li> </ul>	1	36464+200n 36465+200n

## [Pr.434] Speed change gear

Set the arrangement for the speed change gear.

Setting value	Details
0: No speed change gear	Speed change is not processed, and the input value is transmitted as is.
1: Main shaft side	Speed change is processed for input value after main shaft clutch based on the speed change ratio settings.
2: Auxiliary shaft side	Speed change is processed for input value after auxiliary shaft clutch based on the speed change ratio settings.
3: After composite auxiliary shaft gear	Speed change is processed for input value after composite auxiliary shaft gear based on the speed change ratio settings.

## [Pr.435] Speed change gear smoothing time constant

Set the averaging time to execute a smoothing process for the speed change for the speed change gear.

The input response is delayed depending on the time set in the speed change gear smoothing time constant.

Speed is changed directly when "0" is set.

## [Pr.436] Speed change ratio: Numerator, [Pr.437] Speed change ratio: Denominator

Set the numerator and the denominator for the speed change ratio.

"[Pr.436] Speed change ratio: Numerator" and "[Pr.437] Speed change ratio: Denominator" can be changed during synchronous control.

Input values for speed change are processed as follows.

$$\text{Input value after change} = \text{Input value before change} \times \frac{[\text{Pr.436}] \text{ Speed change ratio: Numerator}}{[\text{Pr.437}] \text{ Speed change ratio: Denominator}}$$

The input speed can be reversed by setting a negative value in "[Pr.436] Speed change ratio: Numerator".

"[Pr.437] Speed change ratio: Denominator" is set within the range from 1 to 2147483647.

# 4.5 Output Axis Module

## Overview of output axis module

For the output axis module, the cam axis current value per cycle is calculated based on the input value (the output value from a speed change gear), and is converted based on the set cam data. The feed current value which is a command is output to the servo amplifier.

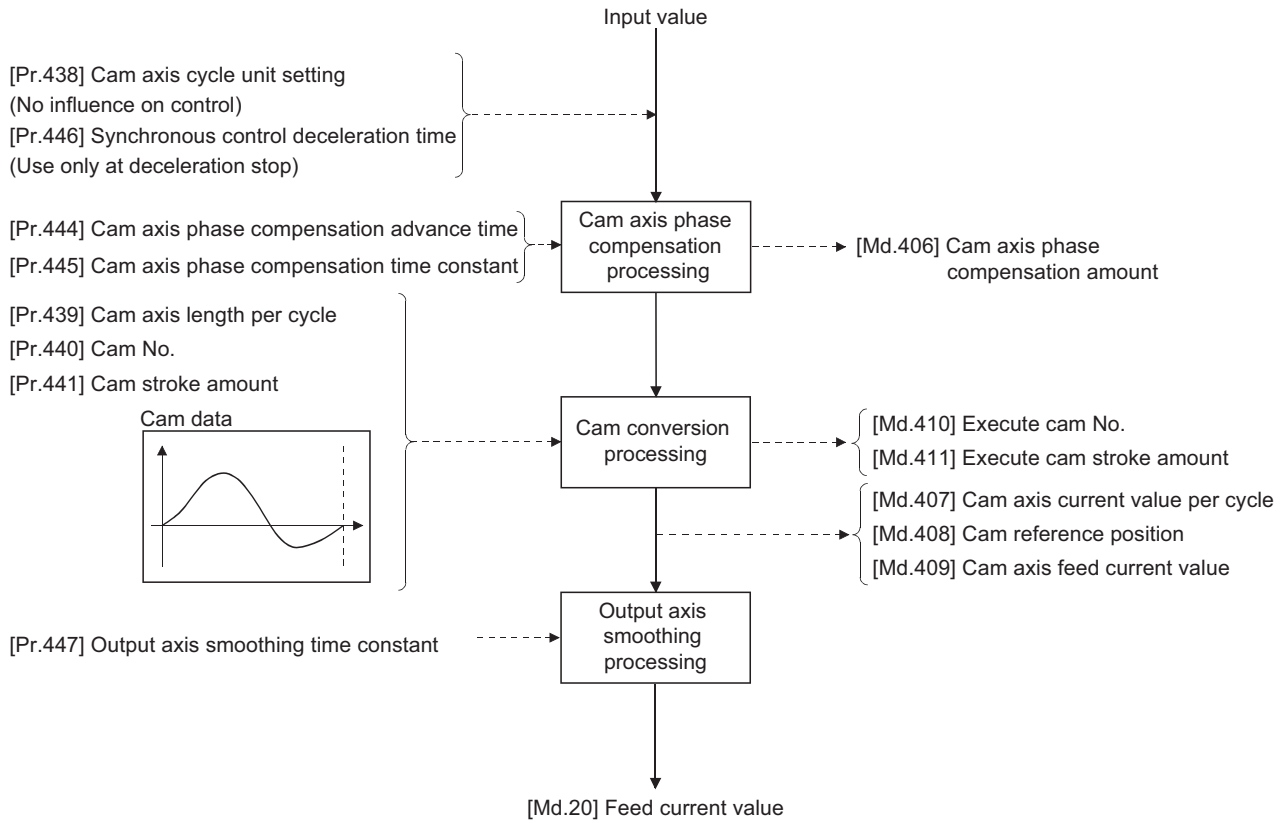



## Units for the output axis

The position units for the output axis are shown below based on the setting "[Pr.1] Unit setting".

Setting value of "[Pr.1] Unit setting"	Output axis position unit	Range
0: mm	$\times 10^{-4}$ mm ( $\times 10^{-1}$ $\mu$ m)	-214748.3648 to 214748.3647 [mm] (-214748364.8 to 214748364.7 [ $\mu$ m])
1: inch	$\times 10^{-5}$ inch	-21474.83648 to 21474.83647 [inch]
2: degree	$\times 10^{-5}$ degree	-21474.83648 to 21474.83647 [degree]
3: pulse	pulse	-2147483648 to 2147483647 [pulse]

Cam axis cycle units are shown below based on the setting "[Pr.438] Cam axis cycle unit setting".

Setting value of "[Pr.438] Cam axis cycle unit setting"			Cam axis cycle unit	Range
Unit setting selection	Control unit	Number of decimal places		
0: Use units of main input axis	—	—	Servo input axis position unit (☞ Page 28 Servo input axis position units) Synchronous encoder axis position unit (☞ Page 58 Synchronous encoder axis position units)	
1: Use units of this setting	0: mm	0	mm	-2147483648 to 2147483647 [mm]
		∴	∴	∴
		9	$\times 10^{-9}$ mm	-2.147483648 to 2.147483647 [mm]
	1: inch	0	inch	-2147483648 to 2147483647 [inch]
		∴	∴	∴
		9	$\times 10^{-9}$ inch	-2.147483648 to 2.147483647 [inch]
	2: degree	0	degree	-2147483648 to 2147483647 [degree]
		∴	∴	∴
		9	$\times 10^{-9}$ degree	-2.147483648 to 2.147483647 [degree]
	3: pulse	0	pulse	-2147483648 to 2147483647 [pulse]
		∴	∴	∴
		9	$\times 10^{-9}$ pulse	-2.147483648 to 2.147483647 [pulse]

# Output axis parameters

n: Axis No. - 1

Setting item	Setting details	Setting value	Default value	Buffer memory address
[Pr.438] Cam axis cycle unit setting	<ul style="list-style-type: none"> <li>Set the units for the cam axis length per cycle.</li> <li>There is no influence on the control for the parameter for monitor display.</li> </ul> <p>Fetch cycle: <u>At start of synchronous control</u></p>	<p>■Set in hexadecimal.</p>	0000H	36470+200n
[Pr.439] Cam axis length per cycle	<ul style="list-style-type: none"> <li>Set the required input amount with the cam per cycle.</li> </ul> <p>Fetch cycle: <u>At start of synchronous control</u></p>	<p>■Set in decimal.</p> <p>1 to 2147483647 [Cam axis cycle units*<sup>1</sup>]</p>	4194304	36472+200n 36473+200n
[Pr.440] Cam No.	<ul style="list-style-type: none"> <li>Set the cam No.</li> </ul> <p>Fetch cycle: <u>At start of synchronous control, At passing through the 0th point of cam data</u></p>	<p>■Set in decimal.</p> <p>0: Linear cam (Preset) 1 to 256: User created cam</p>	0	36474+200n
[Pr.441] Cam stroke amount	<ul style="list-style-type: none"> <li>Set the cam stroke amount corresponding to the stroke ratio 100% for cam with stroke ratio data format.</li> <li>This is ignored for cams using the coordinate data format.</li> </ul> <p>Fetch cycle: <u>At start of synchronous control, At passing through the 0th point of cam data</u></p>	<p>■Set in decimal.</p> <p>-2147483648 to 2147483647 [Output axis position units*<sup>2</sup>]</p>	4194304	36476+200n 36477+200n
[Pr.444] Cam axis phase compensation advance time	<ul style="list-style-type: none"> <li>Set the time to advance or delay the phase of the cam axis.</li> </ul> <p>Fetch cycle: <u>Operation cycle</u></p>	<p>■Set in decimal.</p> <p>-2147483648 to 2147483647 [μs]</p>	0	36482+200n 36483+200n
[Pr.445] Cam axis phase compensation time constant	<ul style="list-style-type: none"> <li>Set the time constant to affect the phase compensation of the cam axis.</li> </ul> <p>Fetch cycle: <u>At start of synchronous control</u></p>	<p>■Set in decimal.</p> <p>0 to 65535 [ms]<sup>3</sup></p>	10	36484+200n
[Pr.446] Synchronous control deceleration time	<ul style="list-style-type: none"> <li>Set the deceleration time for the synchronous control.</li> </ul> <p>Fetch cycle: <u>At start of synchronous control</u></p>	<p>■Set in decimal.</p> <p>0 to 65535 [ms]<sup>3</sup></p>	0	36485+200n
[Pr.447] Output axis smoothing time constant	<ul style="list-style-type: none"> <li>Set to smooth the output axis.</li> </ul> <p>Fetch cycle: <u>At start of synchronous control</u></p>	<p>■Set in decimal.</p> <p>0 to 5000 [ms]</p>	0	36486+200n

\*1 Cam axis cycle units (☞ Page 127 Units for the output axis)

\*2 Output axis position units (☞ Page 127 Units for the output axis)

\*3 Set the value as follows in a program.

0 to 32767: Set as a decimal

32768 to 65535: Convert into a hexadecimal and set

## [Pr.438] Cam axis cycle unit setting

Set the command units for the cam axis input per cycle to be used for cam control.

These units are used for setting the cam axis length per cycle and the cam axis current value per cycle.

There is no influence on the control for the parameter for monitor display.

Refer to the following.

☞ Page 126 Overview of output axis module

## [Pr.439] Cam axis length per cycle

Set the length per cycle of the cam axis to generate the cam axis current value per cycle.

The unit settings are in the cam axis cycle units (☞ Page 127 Units for the output axis).

Set a value within the range from 1 to 2147483647.

## [Pr.440] Cam No.

Set the cam No. for cam control.

Cam No.0 operates as a linear cam for 100% of its stroke ratio along the cam axis length per cycle.

The cam No. can be changed during synchronous control.

The value set in "[Pr.440] Cam No." is valid when the cam axis current value per cycle passes through the 0th point of cam data, or is on the 0th point.

## [Pr.441] Cam stroke amount

Set the cam stroke amount corresponding to a 100% stroke ratio in output axis position units (  Page 127 Units for the output axis) for cam control using the stroke ratio data format.

The cam stroke amount can be changed during synchronous control.

The value set in "[Pr.441] Cam stroke amount" is valid when the cam axis current value per cycle passes through the 0th point of cam data, or is on the 0th point.

The setting value is ignored for a cam using the coordinate data format.

## [Pr.444] Cam axis phase compensation advance time

Set the time to advance or delay the phase of the cam axis current value per cycle in the cam control.

Setting value	Details
1 to 2147483647 [ $\mu$ s]	Advance the phase according to the setting time.
0 [ $\mu$ s]	Do not execute phase compensation.
-2147483648 to -1 [ $\mu$ s]	Delay the phase according to the setting time.

If the setting time is too long, the system experiences overshoot or undershoot at acceleration/deceleration of the input speed. In this case, set a longer time to affect the phase compensation amount in "[Pr.445] Cam axis phase compensation time constant".

## [Pr.445] Cam axis phase compensation time constant

Set the time constant to affect the phase compensation amount for the first order delay.

63 [%] of the phase compensation amount is reflected in the time constant setting.

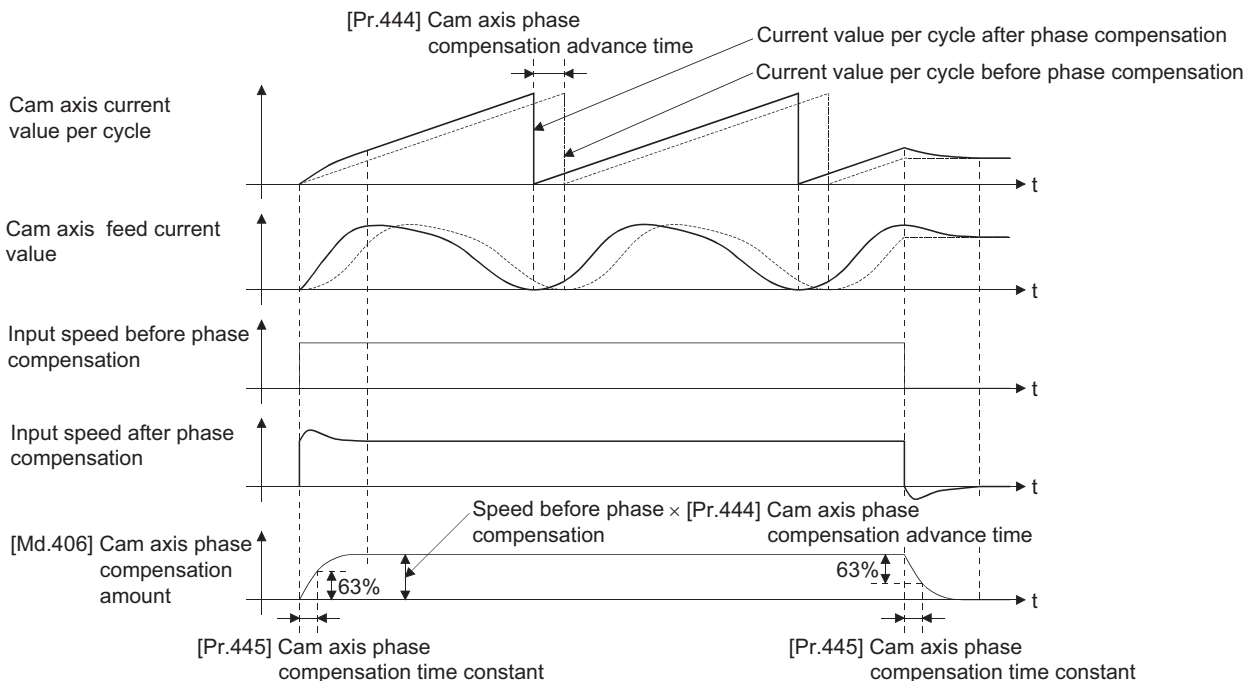

## [Pr.446] Synchronous control deceleration time

Set the time to decelerate to a stop when deceleration stop occurs during synchronous control.

Set the time from "[Pr.8] Speed limit value" until the speed becomes 0 in units of ms.

Operation assumes an immediate stop when "0" is set.

## [Pr.447] Output axis smoothing time constant

Set the averaging time to execute a smoothing process for the movement amount of the output axis after cam data conversion.

The smoothing process can moderate rapid speed fluctuation for cams using the coordinate data format, etc.

The input response is delayed depending on the time corresponding to the setting by smoothing process setting.

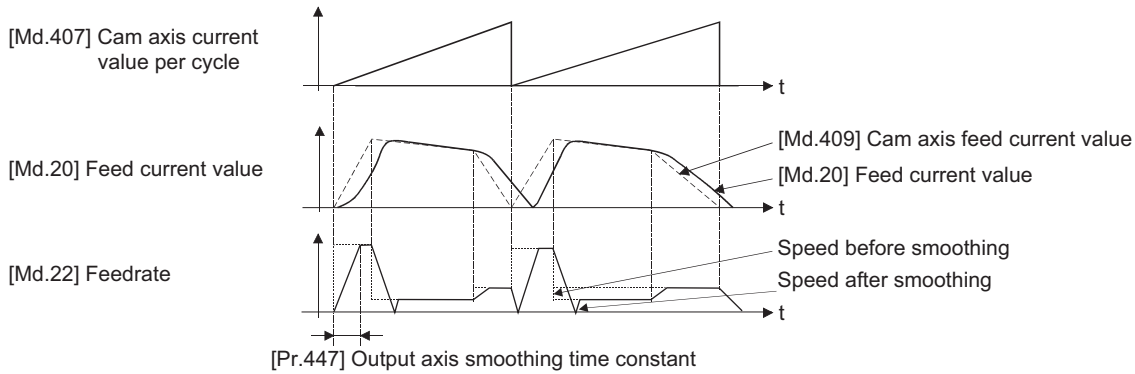

# 4.6 Synchronous Control Change Function

## Overview of synchronous control change function

This function can change the cam reference position, the cam axis current value per cycle and the current value per cycle after the main/auxiliary shaft gear during the synchronous control.

The following 5 methods exist for the synchronous control change function. Refer to the following on each change command.

☞ Page 131 Synchronous control change control data

Synchronous control change command	Application	Output axis operation
Cam reference position movement	Adjust the cam reference position by the movement amount.	Operated
Change cam axis current value per cycle	Change the cam axis current value per cycle.	None
Change current value per cycle after main shaft gear	Change the current value per cycle after main shaft gear.	None
Change current value per cycle after auxiliary shaft gear	Change the current value per cycle after auxiliary shaft gear.	None
Cam axis current value per cycle movement	Adjust the phase of the cam axis by the movement amount.	Operated

## Synchronous control change control data

n: Axis No. - 1

Setting item	Setting details	Setting value	Default value	Buffer memory address
[Cd.406] Synchronous control change request	<ul style="list-style-type: none"> <li>Set "1" to initiate a synchronous control change command request. The value is reset to "0" automatically after completion of the synchronous control change.</li> </ul> Fetch cycle: Operation cycle	■Set in decimal. 1: Synchronous control change request	0	44086+20n
[Cd.407] Synchronous control change command	<ul style="list-style-type: none"> <li>Set the synchronous control change command.</li> </ul> Fetch cycle: At requesting synchronous control change	■Set in decimal. 0: Cam reference position movement 1: Change cam axis current value per cycle 2: Change current value per cycle after main shaft gear 3: Change current value per cycle after auxiliary shaft gear 4: Cam axis current value per cycle movement	0	44087+20n
[Cd.408] Synchronous control change value	<ul style="list-style-type: none"> <li>Set the change value for synchronous control change processing.</li> </ul> Fetch cycle: At requesting synchronous control change	■Set in decimal. -2147483648 to 2147483647 (Refer to the detailed explanation for units.)	0	44088+20n 44089+20n
[Cd.409] Synchronous control reflection time	<ul style="list-style-type: none"> <li>Set the reflection time for synchronous control change processing.</li> </ul> Fetch cycle: At requesting synchronous control change	■Set in decimal. 0 to 65535[ms] <sup>*1</sup>	0	44090+20n

\*1 Set the value as follows in a program.  
 0 to 32767: Set as a decimal.  
 32768 to 65535: Convert into a hexadecimal and set.

### [Cd.406] Synchronous control change request

Set "1" to initiate "[Cd.407] Synchronous control change command". The Simple Motion module/Motion module resets the value to "0" automatically after completion of the synchronous control change.

The setting is initialized to "0" when starting synchronous control.

## [Cd.407] Synchronous control change command

Set the synchronous control change command.

Setting value	Details	Reference
0	Cam reference position movement	Page 132 Cam reference position movement
1	Change cam axis current value per cycle	Page 132 Change cam axis current value per cycle
2	Change current value per cycle after main shaft gear	Page 133 Change current value per cycle after main shaft gear
3	Change current value per cycle after auxiliary shaft gear	Page 133 Change current value per cycle after auxiliary shaft gear
4	Cam axis current value per cycle movement	Page 133 Cam axis current value per cycle movement

### ■Cam reference position movement

This command is executed to move the cam reference position through adding the setting movement amount of "[Cd.408] Synchronous control change value". The movement amount to be added is averaged in "[Cd.409] Synchronous control reflection time" for its output. Set a long reflection time when a large movement amount is used since the cam axis feed current value moves with the movement amount.

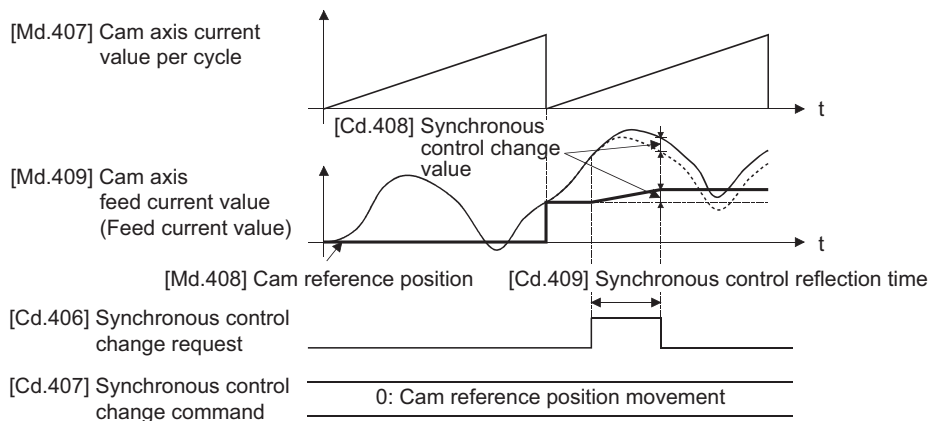

When "[Cd.406] Synchronous control change request" is reset to "0" while executing the cam reference position movement instruction, operation is stopped midway. If the cam reference position movement instruction is executed again, the remainder movement amount is not reflected, and the operation starts with "[Cd.408] Synchronous control change value" to be used again.

If synchronous control is stopped while the cam reference position movement instruction is being executed, operation also stops midway. If synchronous control is restarted, the remainder movement amount is not reflected.

### ■Change cam axis current value per cycle

The cam axis current value per cycle is changed to "[Cd.408] Synchronous control change value". The cam reference position will be also changed to correspond to the changed cam axis current value per cycle.

This operation is completed within one operation cycle.

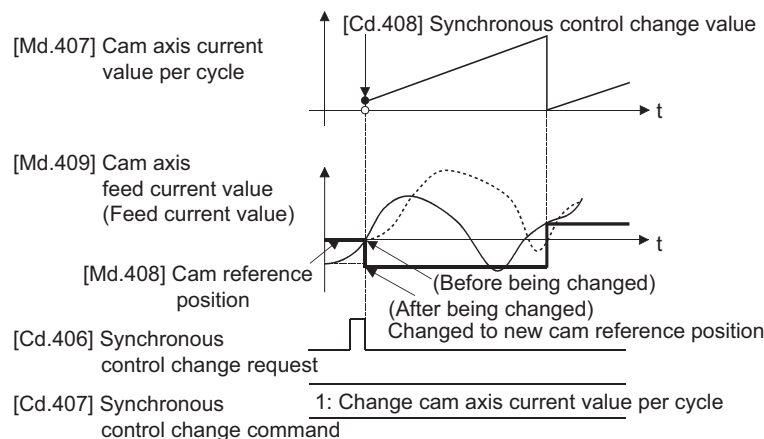

### ■Change current value per cycle after main shaft gear

The current value per cycle after main shaft gear is changed to the value set in "[Cd.408] Synchronous control change value". This operation is completed within one operation cycle.

Clutch control is not executed if the current value per cycle after main shaft gear (the value before being changed and after being changed) has already passed through the ON/OFF address in address mode.

### ■Change current value per cycle after auxiliary shaft gear

The current value per cycle after auxiliary shaft gear is changed to the value set in "[Cd.408] Synchronous control change value".

This operation is completed within one operation cycle.

Clutch control is not executed if the current value per cycle after the auxiliary shaft gear (the value before being changed and after being changed) has already passed through the ON/OFF address in address mode.

### ■Cam axis current value per cycle movement

This command is executed to move the cam axis current value per cycle through adding the setting movement amount of "[Cd.408] Synchronous control change value". The movement amount to be added is averaged in "[Cd.409] Synchronous control reflection time" for its output.

Set a long reflection time when a large movement amount is used since the cam axis feed current value moves with the movement amount.

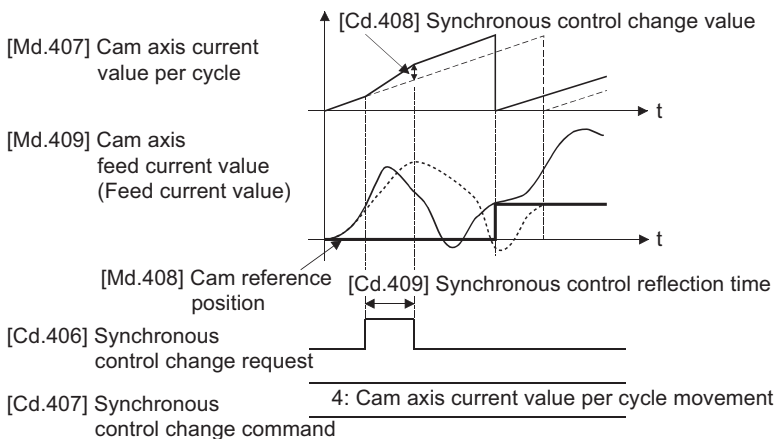

## [Cd.408] Synchronous control change value

Set the change value for synchronous control change processing as follows.

[Cd.407] Synchronous control change command	[Cd.408] Synchronous control change value		
	Setting range	Unit	Setting details
0: Cam reference position movement	-2147483648 to 2147483647	Output axis position unit	<ul style="list-style-type: none"> <li>Set the movement amount of the cam reference position.</li> <li>It moves within the range from -2147483648 to 2147483647.</li> </ul>
1: Change cam axis current value per cycle		Cam axis cycle unit	<ul style="list-style-type: none"> <li>Set the change current value per cycle.</li> <li>The setting value is converted within the range from 0 to (Cam axis length per cycle - 1).</li> </ul>
2: Change current value per cycle after main shaft gear			
3: Change current value per cycle after auxiliary shaft gear			
4: Cam axis current value per cycle movement			

## [Cd.409] Synchronous control reflection time

Set the reflection time for synchronous control change processing as follows.

[Cd.407] Synchronous control change command	Setting details for "[Cd.409] Synchronous control reflection time
0: Cam reference position movement	The time to reflect the movement amount to the cam reference position.
1: Change cam axis current value per cycle	Setting not required.
2: Change current value per cycle after main shaft gear	
3: Change current value per cycle after auxiliary shaft gear	
4: Cam axis current value per cycle movement	The time to reflect the movement amount to the cam axis current value per cycle.



## 4.7 Synchronous Control Monitor Data

Synchronous control monitor data is updated only during synchronous control.

The monitor values ([Md.400], [Md.401], [Md.402], [Md.407], [Md.408], and [Md.409]) from the last synchronous control session are restored the next time the system's power supply turns ON. Restarting operation status from the last synchronous control session is possible through returning to the last position via positioning control (  Page 142 ADVANCED SYNCHRONOUS CONTROL INITIAL POSITION).

"The last synchronous control session" indicates status just before the last synchronous control session was stopped as follows. These are listed with the last synchronization status.

- Just before "[Cd.380] Synchronous control start" turns from ON to OFF.
- Just before deceleration stop by a stop command or an error, etc.
- Just before the system's power supply turned OFF to the Simple Motion module/Motion module.

n: Axis No. - 1

Monitor item	Storage details	Monitor value	Buffer memory address
[Md.400] Current value after composite main shaft gear	<ul style="list-style-type: none"> <li>• The current value after combining the main input and sub input values from the main shaft is stored.</li> <li>• Value is stored even after system's power supply OFF.</li> </ul> <p><u>Refresh cycle: Operation cycle (During synchronous control only)</u></p>	<p>■Monitoring is carried out in decimal display. -2147483648 to 2147483647 [Main input axis position units<sup>*1</sup>]</p>	42800+40n 42801+40n
[Md.401] Current value per cycle after main shaft gear	<ul style="list-style-type: none"> <li>• The current value per cycle after the main shaft gear is stored.</li> <li>• One cycle is considered the cam axis length per cycle.</li> <li>• Value is stored even after system's power supply OFF.</li> </ul> <p><u>Refresh cycle: Operation cycle (During synchronous control only)</u></p>	<p>■Monitoring is carried out in decimal display. 0 to (Cam axis length per cycle - 1) [Cam axis cycle units<sup>*2</sup>]</p>	42802+40n 42803+40n
[Md.402] Current value per cycle after auxiliary shaft gear	<ul style="list-style-type: none"> <li>• The current value per cycle after the auxiliary shaft gear is stored.</li> <li>• One cycle is considered the cam axis length per cycle.</li> <li>• Value is stored even after system's power supply OFF.</li> </ul> <p><u>Refresh cycle: Operation cycle (During synchronous control only)</u></p>	<p>■Monitoring is carried out in decimal display. 0 to (Cam axis length per cycle - 1) [Cam axis cycle units<sup>*2</sup>]</p>	42804+40n 42805+40n
[Md.406] Cam axis phase compensation amount	<ul style="list-style-type: none"> <li>• The current phase compensation amount is stored.</li> </ul> <p><u>Refresh cycle: Operation cycle (During synchronous control only)</u></p>	<p>■Monitoring is carried out in decimal display. -2147483648 to 2147483647 [Cam axis cycle units<sup>*2</sup>]</p>	42810+40n 42811+40n
[Md.407] Cam axis current value per cycle	<ul style="list-style-type: none"> <li>• The current value per cycle is stored, which is calculated from the input movement amount to the cam axis. (The value after phase compensation)</li> <li>• Value is stored even after system's power supply OFF.</li> </ul> <p><u>Refresh cycle: Operation cycle (During synchronous control only)</u></p>	<p>■Monitoring is carried out in decimal display. 0 to (Cam axis length per cycle - 1) [Cam axis cycle units<sup>*2</sup>]</p>	42812+40n 42813+40n
[Md.408] Cam reference position	<ul style="list-style-type: none"> <li>• The feed current value as the cam reference position is stored.</li> <li>• Value is stored even after system's power supply OFF.</li> </ul> <p><u>Refresh cycle: Operation cycle (During synchronous control only)</u></p>	<p>■Monitoring is carried out in decimal display. -2147483648 to 2147483647 [Output axis position units<sup>*3</sup>]</p>	42814+40n 42815+40n
[Md.409] Cam axis feed current value	<ul style="list-style-type: none"> <li>• The feed current value while controlling the cam axis is stored.</li> <li>• Value is stored even after system's power supply OFF.</li> </ul> <p><u>Refresh cycle: Operation cycle (During synchronous control only)</u></p>	<p>■Monitoring is carried out in decimal display. -2147483648 to 2147483647 [Output axis position units<sup>*3</sup>]</p>	42816+40n 42817+40n

Monitor item	Storage details	Monitor value	Buffer memory address
[Md.410] Execute cam No.	• The executing cam No. is stored. Refresh cycle: Operation cycle (During synchronous control only)	■Monitoring is carried out in decimal display. 0 to 256	42818+40n
[Md.411] Execute cam stroke amount	• The executing cam stroke amount is stored. Refresh cycle: Operation cycle (During synchronous control only)	■Monitoring is carried out in decimal display. -2147483648 to 2147483647 [Output axis position units <sup>*3</sup> ]	42820+40n 42821+40n
[Md.420] Main shaft clutch ON/OFF status	• The ON/OFF status of main shaft clutch is stored. Refresh cycle: Operation cycle (During synchronous control only)	■Monitoring is carried out in decimal display. 0: Clutch OFF status 1: Clutch ON status	42828+40n
[Md.421] Main shaft clutch smoothing status	• The smoothing status of main shaft clutch is stored. Refresh cycle: Operation cycle (During synchronous control only)	■Monitoring is carried out in decimal display. 0: Not on clutch smoothing 1: On clutch smoothing	42829+40n
[Md.422] Main shaft clutch slippage (accumulative)	• The accumulative slippage of the main shaft clutch smoothing with slippage method is stored as a signed value. Refresh cycle: Operation cycle (During synchronous control only)	■Monitoring is carried out in decimal display. -2147483648 to 2147483647 [Main input axis position units <sup>*1</sup> or Cam axis cycle units <sup>*2</sup> ]	42830+40n 42831+40n
[Md.423] Auxiliary shaft clutch ON/OFF status	• The ON/OFF status of the auxiliary shaft clutch is stored. Refresh cycle: Operation cycle (During synchronous control only)	■Monitoring is carried out in decimal display. 0: Clutch OFF status 1: Clutch ON status	42832+40n
[Md.424] Auxiliary shaft clutch smoothing status	• The smoothing status of the auxiliary shaft clutch is stored. Refresh cycle: Operation cycle (During synchronous control only)	■Monitoring is carried out in decimal display. 0: Not on clutch smoothing 1: On clutch smoothing	42833+40n
[Md.425] Auxiliary shaft clutch slippage (accumulative)	• The accumulative slippage on the auxiliary shaft clutch smoothing with slippage method is stored as a signed value. Refresh cycle: Operation cycle (During synchronous control only)	■Monitoring is carried out in decimal display. -2147483648 to 2147483647 [Auxiliary shaft position units <sup>*4</sup> or Cam axis cycle units <sup>*2</sup> ]	42834+40n 42835+40n

\*1 Main input axis position units (☞ Page 27 INPUT AXIS MODULE)

\*2 Cam axis cycle units (☞ Page 127 Units for the output axis)

\*3 Output axis position units (☞ Page 127 Units for the output axis)

\*4 Auxiliary shaft position units (☞ Page 27 INPUT AXIS MODULE)

## [Md.400] Current value after composite main shaft gear

The current value after combining the main input and the sub input values going into the composite main shaft gear is stored as an accumulative value.

Units are in position units of the main input axis (☞ Page 27 INPUT AXIS MODULE). The unit is pulse if the main input axis is invalid.

The current value after composite main shaft gear will be changed when the following operations are executed in the main input axis during synchronous control.

Operations of main input axis (Synchronous control)	Servo input axis		Command generation axis	Synchronous encoder axis
	Absolute position detection system: valid	Absolute position detection system: invalid		
Home position return	Change method 1)		—	—
Current value change	Change method 1)		Change method 1)	Change method 1)
Speed control <sup>*1</sup>	Change method 1)		Change method 1)	—
Fixed-pitch feed control	Change method 1)		—	—
Speed-position switching control <sup>*1</sup>	Change method 1)		Change method 1)	—
Position-speed switching control <sup>*1</sup>	Change method 1)		—	—
Connection to servo amplifier	Change method 2)	Change method 1)	—	—
Connection to synchronous encoder	—		—	Change method 1)

\*1 When "2: Clear feed current value to zero" is set in "[Pr.21] Feed current value during speed control" only.

Change method 1): The new current value after composite main shaft gear is calculated based on the current value of the main input axis.

Current value after composite main shaft gear = Main input direction of composite main shaft gear × Main input axis current value

Change method 2): The movement amount of the main input axis from the last synchronous control session is reflected to the current value after composite main shaft gear.

Current value after composite main shaft gear = Current value after composite main shaft gear × Movement amount of main input axis from the last synchronous control session

### **[Md.401] Current value per cycle after main shaft gear**

The input movement amount after the main shaft gear is stored within the range from 0 to (Cam axis length per cycle - 1). The unit is in cam axis cycle units (  Page 127 Units for the output axis).

The value is restored according to "[Pr.460] Setting method of current value per cycle after main shaft gear" when starting synchronous control. (  Page 142 Synchronous Control Initial Position)

### **[Md.402] Current value per cycle after auxiliary shaft gear**

The input movement amount after the auxiliary shaft gear is stored within the range from 0 to (Cam axis length per cycle - 1).

The unit is in cam axis cycle units (  Page 127 Units for the output axis).

The value is restored according to "[Pr.461] Setting method of current value per cycle after auxiliary shaft gear" when starting synchronous control. (  Page 142 Synchronous Control Initial Position)

### **[Md.406] Cam axis phase compensation amount**

The phase compensation amount for the cam axis is stored with cam axis cycle units (  Page 127 Units for the output axis).

The phase compensation amount after smoothing processing with "[Pr.445] Cam axis phase compensation time constant" is stored.

### **[Md.407] Cam axis current value per cycle**

The cam axis current value per cycle is stored within the range from 0 to (Cam axis length per cycle - 1).

The current value after cam axis phase compensation processing can be monitored. The unit is in cam axis cycle units (  Page 127 Units for the output axis).

The value is restored according to "[Pr.462] Cam axis position restoration object" when starting synchronous control. (  Page 142 Synchronous Control Initial Position)

### **[Md.408] Cam reference position**

The feed current value is stored as the cam reference position. The unit is in output axis position units (  Page 127 Units for the output axis). When the unit is in degrees, a range from 0 to 35999999 is used.

The value is restored according to "[Pr.462] Cam axis position restoration object" when starting synchronous control. (  Page 142 Synchronous Control Initial Position)

### **[Md.409] Cam axis feed current value**

The feed current value of the cam axis is stored. The value is the same as "[Md.20] Feed current value" during synchronous control.

### **[Md.410] Execute cam No.**

The executing cam No. is stored.

When "[Pr.440] Cam No." is changed during synchronous control, this is updated when the controlling cam No. switches.

### **[Md.411] Execute cam stroke amount**

The executing cam stroke amount is stored.

When "[Pr.441] Cam stroke amount" is changed during synchronous control, this is updated when the controlling cam stroke amount switches.

## [Md.420] Main shaft clutch ON/OFF status

The clutch ON/OFF status is stored.

## [Md.421] Main shaft clutch smoothing status

The smoothing status of the clutch is stored. The status is updated by the clutch smoothing method as follows.

Method	Details
Time constant method	The status is always "1: On clutch smoothing" during the clutch ON status. The status will be "0: Not on clutch smoothing" when the clutch is turned OFF and smoothing is completed.
Slippage method	The status is "1: On clutch smoothing" till the clutch accumulative slippage amount reaches the slippage at clutch ON when the clutch is turned ON. The status will change to "0: Not on clutch smoothing" when the clutch accumulative slippage amount reaches the slippage at clutch ON. The status is "1: On clutch smoothing" till the clutch accumulative slippage amount reaches 0 when the clutch is turned OFF. The status will change to "0: Not on clutch smoothing" when the clutch accumulative slippage amount reaches 0.

## [Md.422] Main shaft clutch slippage (accumulative)

The accumulative slippage amount with the slippage method is stored as a signed value.

The absolute value of the accumulative slippage increases to reach the slippage at clutch ON during clutch ON.

The absolute value of the accumulative slippage decreases to reach 0 during clutch OFF.

Monitoring of the accumulative slippage is used to check the smoothing progress with the slippage method.

## [Md.423] Auxiliary shaft clutch ON/OFF status

The clutch ON/OFF status is stored.

## [Md.424] Auxiliary shaft clutch smoothing status

The smoothing status of the clutch is stored. The status is updated by the clutch smoothing method as follows.

Method	Details
Time constant method	The status is always "1: On clutch smoothing" during the clutch ON status. The status will be "0: Not on clutch smoothing" when the clutch is turned OFF and smoothing is completed.
Slippage method	The status is "1: On clutch smoothing" till the clutch accumulative slippage amount reaches the slippage at clutch ON when the clutch is turned ON. The status will change to "0: Not on clutch smoothing" when the clutch accumulative slippage amount reaches the slippage at clutch ON. The status is "1: On clutch smoothing" till the clutch accumulative slippage amount reaches 0 when the clutch is turned OFF. The status will change to "0: Not on clutch smoothing" when the clutch accumulative slippage amount reaches 0.

## [Md.425] Auxiliary shaft clutch slippage (accumulative)

The accumulative slippage amount with the slippage method is stored as a signed value.

The absolute value of the accumulative slippage increases to reach the slippage at clutch ON during clutch ON.

The absolute value of the accumulative slippage decreases to reach 0 during clutch OFF.

Monitoring of the accumulative slippage is used to check the smoothing progress with the slippage method.

## 4.8 Phase Compensation Function

In synchronous control, delays in progresses, etc. cause the phase to deviate at the output axis motor shaft end with respect to the input axis (servo input axis or synchronous encoder axis). The phase compensation function compensates in this case so that the phase does not deviate.

Phase compensation can be set for the input and the output axis. It is possible to compensate using the delay time inherent to the system based on the servo input axis or the synchronous encoder axis on the input axis side. It is also possible to use a compensation delay time equivalent to the position deviation for each servo amplifier on the output axis side.

### Phase compensation of delay time of the input axis

Set delay time inherent to the system in the phase compensation advance time of the input axis ("[Pr.302] Servo input axis phase compensation advance time", "[Pr.326] Synchronous encoder axis phase compensation advance time").

The delay time inherent to the system is shown below.

#### ■ Delay time inherent to the system for a servo input axis

[FX5-SSC-S]

Operation cycle [ms]	[Pr.300] Servo input axis type			
	Feed current value	Real current value	Command to servo amplifier	Feedback value
0.888	0 [μs]	1833 [μs]	0 [μs]	3611 [μs]
1.777	0 [μs]	1833 [μs]	0 [μs]	5389 [μs]

[FX5-SSC-G]

Operation cycle [ms]	[Pr.300] Servo input axis type			
	Feed current value	Real current value	Command to servo amplifier	Feedback value
0.500	0 [μs]	3250 [μs]	0 [μs]	3250 [μs]
1.000	0 [μs]	5751 [μs]	0 [μs]	5751 [μs]
2.000	0 [μs]	10751 [μs]	0 [μs]	10751 [μs]
4.000	0 [μs]	20751 [μs]	0 [μs]	20750 [μs]

#### ■ Delay time inherent to the system for a synchronous encoder axis

[FX5-SSC-S]

Operation cycle [ms]	[Pr.320] Synchronous encoder axis type		
	Incremental synchronous encoder	Synchronous encoder via servo amplifier	Synchronous encoder via CPU
0.888	2265 [μs]	3653 [μs]	2265 + Scan time [μs]
1.777	3953 [μs]	5413 [μs]	3953 + Scan time [μs]

[FX5-SSC-G]

Operation cycle [ms]	[Pr.320] Synchronous encoder axis type	
	Synchronous encoder via servo amplifier	Synchronous encoder via CPU
0.500	3251 [μs]	3252 + Scan time [μs]
1.000	5760 [μs]	5751 + Scan time [μs]
2.000	10754 [μs]	10751 + Scan time [μs]
4.000	20763 [μs]	20750 + Scan time [μs]

### Phase compensation of delay time of the output axis

Set delay time equivalent to the position deviation on the servo amplifier in "[Pr.444] Cam axis phase compensation advance time" for the output axis. The delay time equivalent to position deviation of the servo amplifier is calculated using the following formula. (When using MR-J3(W)-B, MR-J4(W)-B, MR-J5(W)-G, and MR-JE-B(F))

Delay time [μs] = 1000000 / Servo parameter "Model loop gain (PB07)"

When the feed forward gain is set, the delay time is set to a smaller value than the value listed above.

The model loop gain will change when the gain adjustment method is auto tuning mode 1 or 2. The model loop gain must not be changed on the axis executing phase compensation through preventing change with the manual mode or interpolation mode setting.

## Setting example

When axis 1 is synchronized with an incremental synchronous encoder axis, the phase compensation advance time is set as follows.

(If MR-J4(W)-B, the operation cycle is as 1.77 [ms], and model loop gain of axis 1 is as 80.)

Setting item	Setting value
[Pr.326] Synchronous encoder axis phase compensation advance time	3953 [ $\mu$ s] For the delay time inherent to the system for a synchronous encoder axis, refer to the following.  Page 139 Delay time inherent to the system for a synchronous encoder axis
[Pr.444] Cam axis phase compensation advance time	$1000000 / 80 = 12500$ [ $\mu$ s]

When overshoot or undershoot occurs during acceleration/deceleration, set a longer time for the phase compensation time constant.

## 4.9 Output Axis Sub Functions

The following shows which sub functions apply for the output axis in synchronous control.

○: Valid, —: Invalid

Sub function	Output axis	Details
Backlash compensation function	○	The same control as other methods.
Electronic gear function	○	
Speed limit function	—	Setting is ignored. ("[Pr.8] Speed limit value" must be set to use "[Pr.446] Synchronous control deceleration time".)
Torque limit function	○	Controlled with "[Pr.17] Torque limit setting value" or "[Cd.101] Torque output setting value" similar to other methods.
Software stroke limit function	○	The axis stops immediately when exceeding the software stroke limit range. To disable the software stroke limit, set the setting value so that "Upper limit value = Lower limit value".
Hardware stroke limit function	○	Controlled the same as positioning control.
Forced stop function	○	Same control as other methods.
Speed change function	—	Setting is ignored.
Override function	—	
Acceleration/deceleration time change function	—	
Torque change function	○	
Absolute system	○	Same control as other methods.
Step function	—	
Skip function	—	Setting is ignored.
M code output function	—	
Teaching function	—	Setting is ignored.
Target position change function	—	
Command in-position function	—	
Acceleration/deceleration processing function	○	Valid at deceleration stop only. Deceleration time is set in "[Pr.446] Synchronous control deceleration time".
Pre-reading start function	—	Setting is ignored.
Deceleration start flag function	—	
Stop command processing for deceleration stop function	—	
Speed control 10 × multiplier setting for degree axis function	○	Reflected on monitor data.
Operation setting for incompletion of home position return function	○	Controlled the same as positioning control. For a system that needs alignment, start synchronous control after establishing an a home position.
Servo ON/OFF	○	Servo OFF request is ignored during synchronous control s similar to positioning control.

### Point

Sub functions for an input axis in synchronous control conform to the specification of each control (Home position return control, Positioning control, Manual control, Speed torque control). Refer to "CONTROL SUB FUNCTIONS" in the following manual for details.

 MELSEC iQ-F FX5 Motion Module/Simple Motion Module User's Manual (Application)

The delay time inherent to the system of a command generation axis is 0, so that the phase compensation function does not exist.

# 5 ADVANCED SYNCHRONOUS CONTROL INITIAL POSITION

The initial position for synchronous control is explained in this chapter.

Configure these settings for situations that require initial position alignment for synchronous control.

## 5.1 Synchronous Control Initial Position

The following synchronous control monitor data can be aligned to a set position when starting synchronous control, as the initial position for synchronous control.

The alignment to a synchronous control initial position is useful for restoring a system based on the last control status along with restarting synchronous control after canceling midway.

Synchronous control monitor data	The position when starting synchronous control
[Md.400] Current value after composite main shaft gear	Restored to a position based on the main input axis of the main shaft.
[Md.401] Current value per cycle after main shaft gear	Restored according to "[Pr.460] Setting method of current value per cycle after main shaft gear".
[Md.402] Current value per cycle after auxiliary shaft gear	Restored according to "[Pr.461] Setting method of current value per cycle after auxiliary shaft gear".
[Md.407] Cam axis current value per cycle	Restored according to "[Pr.462] Cam axis position restoration object".
[Md.408] Cam reference position	
[Md.409] Cam axis feed current value	

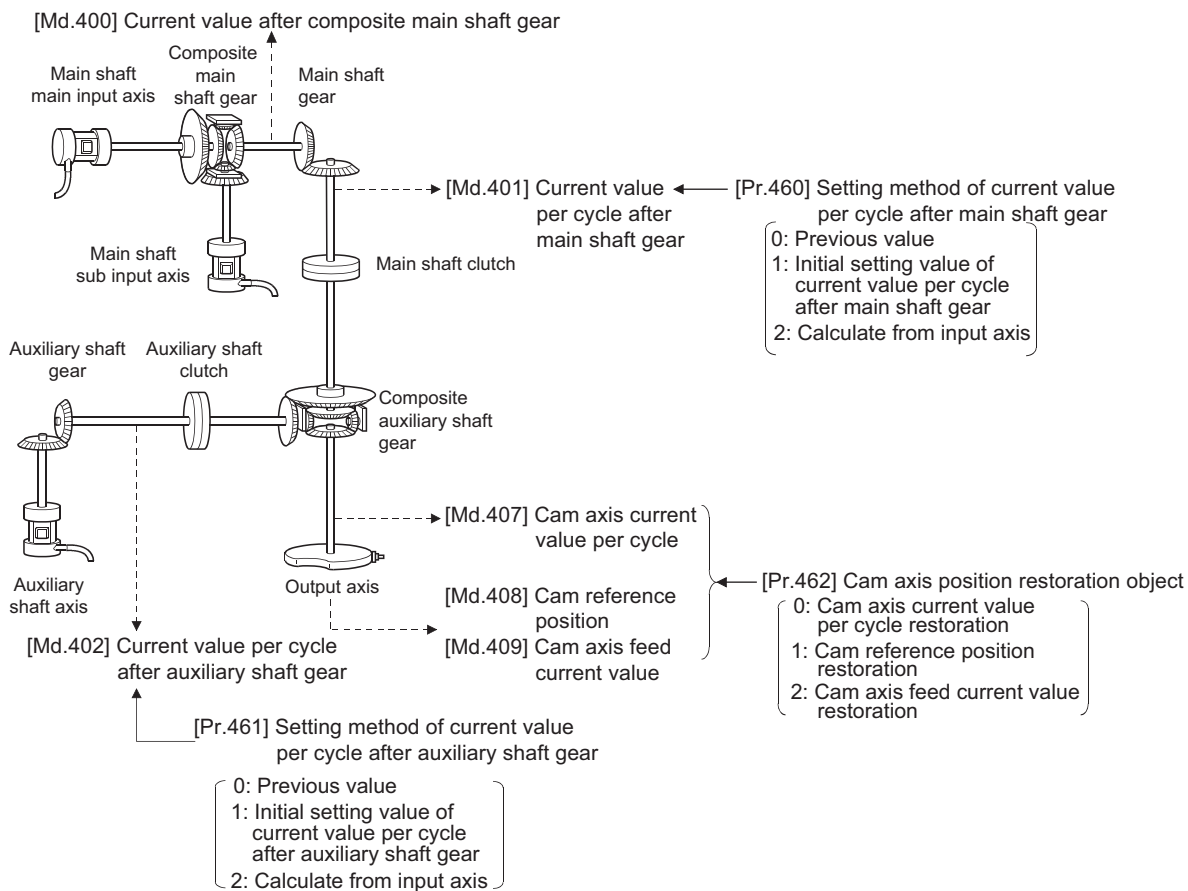



## Current value after composite main shaft gear at synchronous control start

The current value after composite main shaft gear is restored as follows according to the main input axis operation executed before starting synchronous control.

Operation of main input axis (Before synchronous control start)	Servo input axis		Command generation axis	Synchronous encoder axis
	Absolute position detection system valid	Absolute position detection system invalid		
Home position return	Restoration method 1)		—	—
Current value change	Restoration method 1)		Restoration method 1)	Restoration method 1)
Speed control <sup>*1</sup>	Restoration method 1)		Restoration method 1)	—
Fixed-pitch feed control	Restoration method 1)		—	—
Speed-position switching control <sup>*1</sup>	Restoration method 1)		Restoration method 1)	—
Position-speed switching control <sup>*1</sup>	Restoration method 1)		—	—
Connection to servo amplifier	Restoration method 2)	Restoration method 1)	—	—
Connection to synchronous encoder	—		—	Restoration method 1)
Others	Restoration method 2)		Restoration method 2)	Restoration method 2)

\*1 When "[Pr.300] Servo input axis type" is either "1: Feed current value" or "2: Real current value", and when "[Pr.21] Feed current value during speed control" is "2: Clear feed current value to zero" only.

Restoration method 1): The new current value after composite main shaft gear is calculated based on the current value of the main input axis.

Current value after composite main shaft gear =

Main input direction of composite main shaft gear × Main input axis current value

Restoration method 2): The movement amount of the main input axis from the last synchronous control session is reflected to the current value after composite main shaft gear.

Current value after composite main shaft gear =

Current value after composite main shaft gear at the last synchronous control session + Main input direction of composite main shaft gear × Amount of change of main input axis current value from the last synchronous control session

The current value after composite main shaft gear at the last synchronous control session is restored when "0: Invalid" is set in "[Pr.400] Main input axis No.", or when a servo input axis or a synchronous encoder axis as the main input axis is not connected.

### Point

"The last synchronous control session" indicates status just before the last synchronous control session was stopped as follows. These are listed with the last synchronization status.

- Just before "[Cd.380] Synchronous control start" turns from ON to OFF.
- Just before deceleration stop by a stop command or an error, etc.
- Just before the system's power supply turned OFF to the Simple Motion module/Motion module.

## Current value per cycle after main/auxiliary shaft gear at synchronous control start

The current value per cycle after main shaft gear/current value per cycle after auxiliary shaft gear is restored as follows according to the main input axis/auxiliary shaft operation executed before starting synchronous control.

Operation of main input axis/ auxiliary shaft (Before synchronous control start)	Servo input axis		Command generation axis	Synchronous encoder axis
	Absolute position detection system valid	Absolute position detection system invalid		
Home position return	Restoration method 1)		—	—
Current value change	Restoration method 1)		Restoration method 1)	Restoration method 1)
Speed control* <sup>1</sup>	Restoration method 1)		Restoration method 1)	—
Fixed-pitch feed control	Restoration method 1)		—	—
Speed-position switching control* <sup>1</sup>	Restoration method 1)		Restoration method 1)	—
Position-speed switching control* <sup>1</sup>	Restoration method 1)		—	—
Connection to servo amplifier	Restoration method 2)	Restoration method 1)	—	—
Connection to synchronous encoder	—		—	Restoration method 1)
Others	Restoration method 2)		Restoration method 2)	Restoration method 2)

\*1 When "[Pr.300] Servo input axis type" is either "1: Feed current value" or "2: Real current value", and when "[Pr.21] Feed current value during speed control" is "2: Clear feed current value to zero" only.

Restoration method 1): The new value of the current value per cycle after main shaft gear/current value per cycle after auxiliary shaft gear is calculated based on the current value after composite main shaft gear/auxiliary shaft current value.

[Main shaft]

Current value per cycle after main shaft gear = Main shaft gear ratio × Current value after composite main shaft gear

[Auxiliary shaft]

Current value per cycle after auxiliary shaft gear = Auxiliary shaft gear ratio × Auxiliary shaft current value

Restoration method 2): The movement amount from the last synchronous control session is reflected to the current value per cycle after main shaft gear/current value per cycle after auxiliary shaft gear.

[Main shaft]

Current value per cycle after main shaft gear =

Current value per cycle after main shaft gear at the last synchronous control session + Main shaft gear ratio × Amount of change of current value after composite main shaft gear from the last synchronous control session

[Auxiliary shaft]

Current value per cycle after auxiliary shaft gear =

Current value per cycle after auxiliary shaft gear at the last synchronous control session + Auxiliary shaft gear ratio × Amount of change of auxiliary shaft current value from the last synchronous control session

The current value per cycle after main shaft gear/current value per cycle after auxiliary shaft gear at the last synchronous control session is restored when "0: Invalid" is set in "[Pr.400] Main input axis No."/[Pr.418] Auxiliary shaft axis No.", or when a servo input axis or a synchronous encoder axis as the main input axis/auxiliary shaft is not connected.

## Cam axis position at synchronous control start

The cam axis position is composed of the relationship of 3 positions "Cam axis current value per cycle", "Cam reference position" and "Cam axis feed current value". One of positions can be restored by defining 2 positions when starting synchronous control.

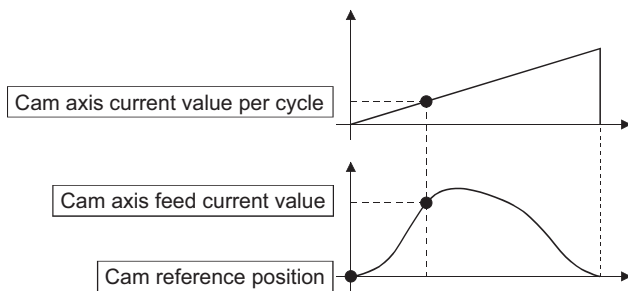

Select from 3 objects as follows in "[Pr.462] Cam axis position restoration object" which position is to be restored. (Refer to [Page 149](#) Cam Axis Position Restoration Method for details on the restoration method.)

- Cam axis current value per cycle restoration
- Cam reference position restoration
- Cam axis feed current value restoration

Various parameters need to be set for the cam axis position restoration as shown below. (Refer to [Page 146](#) Synchronous Control Initial Position Parameters for the setting details.)

○: Required, △: Required for initial setting value, —: Not required

[Pr.462] Cam axis position restoration object	[Pr.463] Setting method of cam reference position	[Pr.467] Cam reference position (Initial setting)	[Pr.464] Setting method of cam axis current value per cycle	[Pr.468] Cam axis current value per cycle (Initial setting)	Restoration processing details
0: Cam axis current value per cycle restoration	○	△	—	○ (Used as search starting point)	Restore "Cam axis current value per cycle" based on "Cam reference position" and "Cam axis feed current value".
1: Cam reference position restoration	—	—	○	△	Restore "Cam reference position" based on "Cam axis current value per cycle" and "Cam axis feed current value".
2: Cam axis feed current value restoration	○	△	○	△	Restore "Cam axis feed current value" based on "Cam axis current value per cycle" and "Cam reference position".

## 5.2 Synchronous Control Initial Position Parameters

n: Axis No. - 1

Setting item	Setting details	Setting value	Default value	Buffer memory address
[Pr.460] Setting method of current value per cycle after main shaft gear	<ul style="list-style-type: none"> <li>Select the setting method for the current value per cycle after main shaft gear.</li> </ul> <u>Fetch cycle: At start of synchronous control</u>	<ul style="list-style-type: none"> <li>■Set in decimal.</li> <li>0: Previous value</li> <li>1: Initial setting value of current value per cycle after main shaft gear ([Pr.465])</li> <li>2: Calculate from input axis</li> </ul>	0	36500+200n
[Pr.461] Setting method of current value per cycle after auxiliary shaft gear	<ul style="list-style-type: none"> <li>Select the setting method for the current value per cycle after auxiliary shaft gear.</li> </ul> <u>Fetch cycle: At start of synchronous control</u>	<ul style="list-style-type: none"> <li>■Set in decimal.</li> <li>0: Previous value</li> <li>1: Initial setting value of current value per cycle after auxiliary shaft gear ([Pr.466])</li> <li>2: Calculate from input axis</li> </ul>	0	36501+200n
[Pr.462] Cam axis position restoration object	<ul style="list-style-type: none"> <li>Select the object to restore the cam axis position.</li> </ul> <u>Fetch cycle: At start of synchronous control</u>	<ul style="list-style-type: none"> <li>■Set in decimal.</li> <li>0: Cam axis current value per cycle restoration</li> <li>1: Cam reference position restoration</li> <li>2: Cam axis feed current value restoration</li> </ul>	0	36502+200n
[Pr.463] Setting method of cam reference position	<ul style="list-style-type: none"> <li>Select the setting method for the cam reference position.</li> <li>Set for the cam axis current value per cycle restoration or the cam axis feed current value restoration.</li> </ul> <u>Fetch cycle: At start of synchronous control</u>	<ul style="list-style-type: none"> <li>■Set in decimal.</li> <li>0: Previous value</li> <li>1: Initial setting value of cam reference position</li> <li>2: Feed current value</li> </ul>	2	36503+200n
[Pr.464] Setting method of cam axis current value per cycle	<ul style="list-style-type: none"> <li>Select the setting method for the cam axis current value per cycle.</li> <li>Set for the cam reference position restoration or the cam axis feed current value restoration.</li> </ul> <u>Fetch cycle: At start of synchronous control</u>	<ul style="list-style-type: none"> <li>■Set in decimal.</li> <li>0: Previous value</li> <li>1: Initial setting value of cam axis current value per cycle</li> <li>2: Current value per cycle after main shaft gear</li> <li>3: Current value per cycle after auxiliary shaft gear</li> </ul>	0	36504+200n
[Pr.465] Current value per cycle after main shaft gear (Initial setting)	<ul style="list-style-type: none"> <li>Set the initial value of the current value per cycle after main shaft gear.</li> </ul> <u>Fetch cycle: At start of synchronous control</u>	<ul style="list-style-type: none"> <li>■Set in decimal.</li> <li>0 to (Cam axis length per cycle - 1)</li> <li>[Cam axis cycle units<sup>*1</sup>]</li> </ul>	0	36506+200n 36507+200n
[Pr.466] Current value per cycle after auxiliary shaft gear (Initial setting)	<ul style="list-style-type: none"> <li>Set the initial value of the current value per cycle after auxiliary shaft gear.</li> </ul> <u>Fetch cycle: At start of synchronous control</u>	<ul style="list-style-type: none"> <li>■Set in decimal.</li> <li>0 to (Cam axis length per cycle - 1)</li> <li>[Cam axis cycle units<sup>*1</sup>]</li> </ul>	0	36508+200n 36509+200n
[Pr.467] Cam reference position (Initial setting)	<ul style="list-style-type: none"> <li>Set the initial value of the cam reference position.</li> </ul> <u>Fetch cycle: At start of synchronous control</u>	<ul style="list-style-type: none"> <li>■Set in decimal.</li> <li>-2147483648 to 2147483647</li> <li>[Output axis position units<sup>*2</sup>]</li> </ul>	0	36510+200n 36511+200n
[Pr.468] Cam axis current value per cycle (Initial setting)	<ul style="list-style-type: none"> <li>Set the initial value for the cam axis current value per cycle.</li> <li>The restoration value for the cam axis current value per cycle is searched from the setting value with the cam axis current value per cycle restoration.</li> </ul> <u>Fetch cycle: At start of synchronous control</u>	<ul style="list-style-type: none"> <li>■Set in decimal.</li> <li>0 to (Cam axis length per cycle - 1)</li> <li>[Cam axis cycle units<sup>*1</sup>]</li> </ul>	0	36512+200n 36513+200n

\*1 Cam axis cycle units (☞ Page 127 Units for the output axis)

\*2 Output axis position units (☞ Page 127 Units for the output axis)

### [Pr.460] Setting method of current value per cycle after main shaft gear

Select the setting method of "[Md.401] Current value per cycle after main shaft gear" when starting synchronous control.

Setting value	Details
0: Previous value	The current value per cycle after main shaft gear from the last synchronous control session is stored.
1: Initial setting value of current value per cycle after main shaft gear	The value set in "[Pr.465] Current value per cycle after main shaft gear (Initial setting)" is stored.
2: Calculate from input axis	The value calculated based on the current value after composite main shaft gear is stored.

### [Pr.461] Setting method of current value per cycle after auxiliary shaft gear

Select the setting method of "[Md.402] Current value per cycle after auxiliary shaft gear" when starting synchronous control.

Setting value	Details
0: Previous value	The current value per cycle after auxiliary shaft gear from the last synchronous control session is stored.
1: Initial setting value of current value per cycle after auxiliary shaft gear	The value set in "[Pr.466] Current value per cycle after auxiliary shaft gear (Initial setting)" is stored.
2: Calculate from input axis	The value calculated based on the auxiliary shaft current value is stored.

### [Pr.462] Cam axis position restoration object

Select the object to be restored from "Cam axis current value per cycle", "Cam reference position" or "Cam axis feed current value" when starting synchronous control.

Setting value	Details
0: Cam axis current value per cycle restoration	Restore the cam axis current value per cycle from "Cam reference position" and "Cam axis feed current value".
1: Cam reference position restoration	Restore the cam reference position from "Cam axis current value per cycle" and "Cam axis feed current value".
2: Cam axis feed current value restoration	Restore the cam axis feed current value from "Cam axis current value per cycle" and "Cam reference position".

### [Pr.463] Setting method of cam reference position

Select the method for the cam reference position to be restored when "[Pr.462] Cam axis position restoration object" is set to "0: Cam axis current value per cycle restoration" or "2: Cam axis feed current value restoration".

Setting value	Details
0: Previous value	The cam reference position from the last synchronous control session is stored. The feed current value is stored when the cam reference position from the last synchronous control session is not saved.
1: Initial setting value of cam reference position	The value set in "[Pr.467] Cam reference position (Initial setting)" is stored.
2: Feed current value	The value set in "[Md.20] Feed current value" is stored.

### [Pr.464] Setting method of cam axis current value per cycle

Select the method for the cam axis current value per cycle to be restored when "[Pr.462] Cam axis position restoration object" is set to "1: Cam reference position restoration" or "2: Cam axis feed current value restoration".

Setting value	Details
0: Previous value	The cam axis current value per cycle from the last synchronous control session is stored as is.
1: Initial setting value of cam axis current value per cycle	The value set in "[Pr.468] Cam axis current value per cycle (Initial setting)" is stored.
2: Current value per cycle after main shaft gear	The current value per cycle after main shaft gear is stored.
3: Current value per cycle after auxiliary shaft gear	The current value per cycle after auxiliary shaft gear is stored.

### [Pr.465] Current value per cycle after main shaft gear (Initial setting)

Set the initial setting value of the current value per cycle after main shaft gear when "[Pr.460] Setting method of current value per cycle after main shaft gear" is set to "1: Current value per cycle after main shaft gear (Initial setting)".

The unit settings are in cam axis cycle units (☞ Page 127 Units for the output axis). Set within the range from 0 to (Cam axis length per cycle - 1).

### [Pr.466] Current value per cycle after auxiliary shaft gear (Initial setting)

Set the initial setting value of the current value per cycle after auxiliary shaft gear when "[Pr.461] Setting method of current value per cycle after auxiliary shaft gear" is set to "1: Current value per cycle after auxiliary shaft gear (Initial setting)".

The unit settings are in cam axis cycle units (☞ Page 127 Units for the output axis). Set within the range from 0 to (Cam axis length per cycle - 1).

### [Pr.467] Cam reference position (Initial setting)

Set the initial setting value of the cam reference position in output axis position units (  Page 127 Units for the output axis) when "[Pr.463] Setting method of cam reference position" is set to "1: Cam reference position (Initial setting)".

### [Pr.468] Cam axis current value per cycle (Initial setting)

Set a value according to the setting for "[Pr.462] Cam axis position restoration object".

The unit settings are in cam axis cycle units (  Page 127 Units for the output axis). Set within the range from 0 to (Cam axis length per cycle - 1).

[Pr.462] Cam axis position restoration object	Setting value
0: Cam axis current value per cycle restoration	Set the starting point for search processing to restore the cam axis current value per cycle. Set to restore the position on the return path in two-way cam pattern operation. Refer to the following for details on search processing.  Page 149 Cam axis current value per cycle restoration
1: Cam reference position restoration	Set the initial setting value for the cam axis current value per cycle when "[Pr.464] Setting method of cam axis current value per cycle" is set to "1: Cam axis current value per cycle (Initial setting)".
2: Cam axis feed current value restoration	

# 5.3 Cam Axis Position Restoration Method

## Cam axis current value per cycle restoration

If "[Pr.462] Cam axis position restoration object" is set to "0: Cam axis current value per cycle restoration" when starting synchronous control, the cam axis current value per cycle is restored based on the cam reference position and the cam axis feed current value.

Select the method for the cam reference position to be restored. The feed current value when starting synchronous control is used as the cam axis feed current value.

The cam axis current value per cycle is restored by searching for the corresponding value from the beginning to the end of the cam pattern. Set the starting point from where to search the cam pattern in "[Pr.468] Cam axis current value per cycle (Initial setting)". (It is also possible to search the return path in a two-way cam pattern operation.)

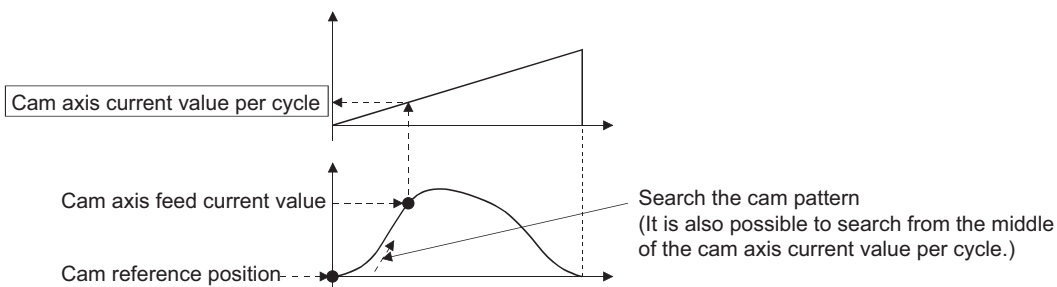
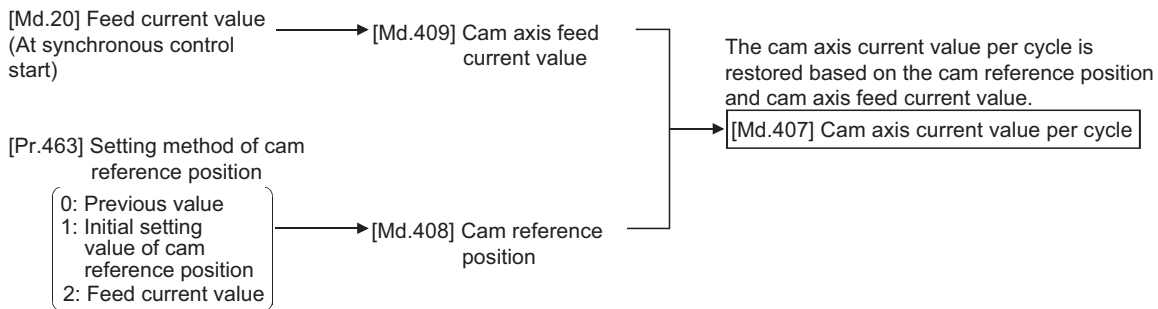

- 
- With two-way cam pattern operation, if the corresponding cam axis current value per cycle is not found, the error "Cam axis current value per cycle restoration disable" (error code: 1C28H [FX5-SSC-S], or error code: 1E78H [FX5-SSC-G]) will occur and synchronous control will not be started.
  - When starting synchronous control, the feed current value may change slightly from its original position at starting synchronous control. This is due to the readjustment of the position based on the restored cam axis current value per cycle. This does not result in the position mismatch.
  - With a feed operation cam pattern, if the corresponding cam axis current value per cycle is not found on the first cycle, the cam reference position is changed automatically and the pattern is searched again.
  - If the cam resolution is large, search processing may take a long time when starting synchronous control.  
[FX5-SSC-S]  
Cam resolution 256: Up to about 1.0 ms, Cam resolution 16384: Up to about 40 ms  
[FX5-SSC-G]  
(Operation cycle 0.500 ms) Cam resolution 256: Up to about 2.2 ms, Cam resolution 16384: Up to about 40 ms  
(Operation cycle 1.000 ms) Cam resolution 256: Up to about 0.6 ms, Cam resolution 16384: Up to about 15 ms
  - When "degree" is the unit for the feed current value of the output axis, the current value cannot be restored in a cam stroke range that straddles 0 [degree] and the error "Cam axis current value per cycle restoration disable" (error code: 1C28H [FX5-SSC-S], or error code: 1E78H [FX5-SSC-G]) will occur. Execute cam axis current value per cycle restoration within a cam stroke range exceeding 0 to and less than 360 [degree].
-



## Cam axis current value per cycle restoration operation

### ■ With a two-way cam pattern operation

- Search from "Cam axis current value per cycle = 0". (Cam data starting point = 0)

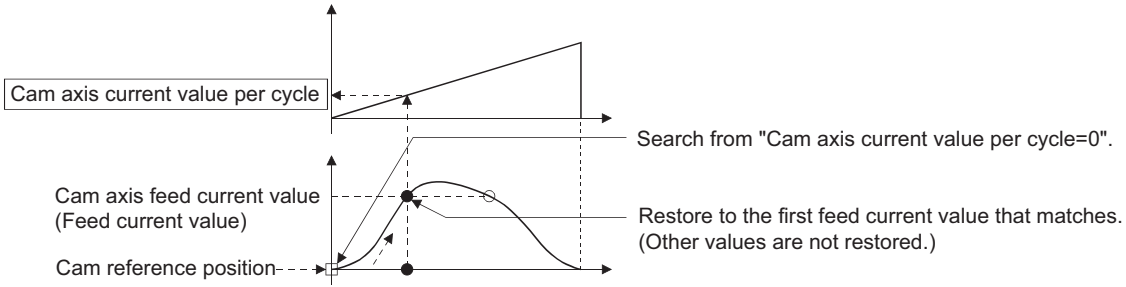

- Search from a value in the middle of the cam axis current value per cycle. (Cam data starting point ≠ 0)

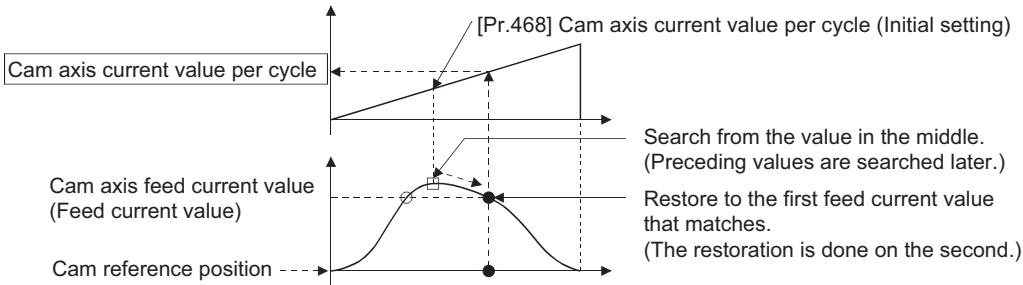

- Search from a value in the middle of the cam axis current value per cycle. (Cam data starting point ≠ 0)

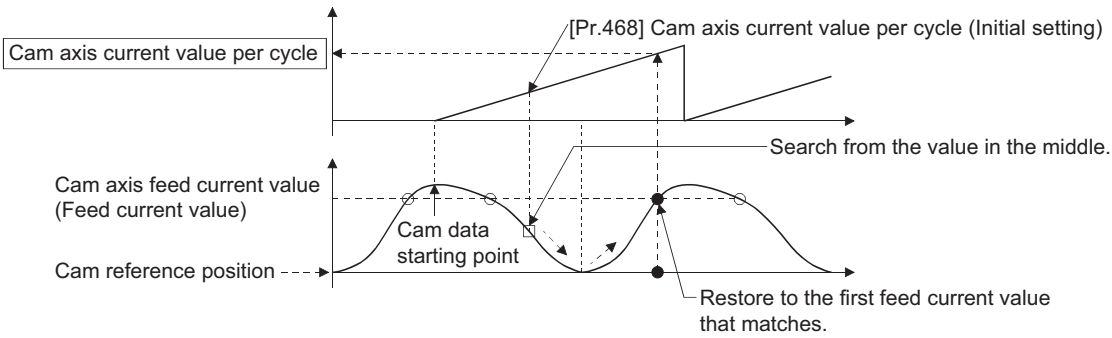

- The search fails. (Pattern 1)

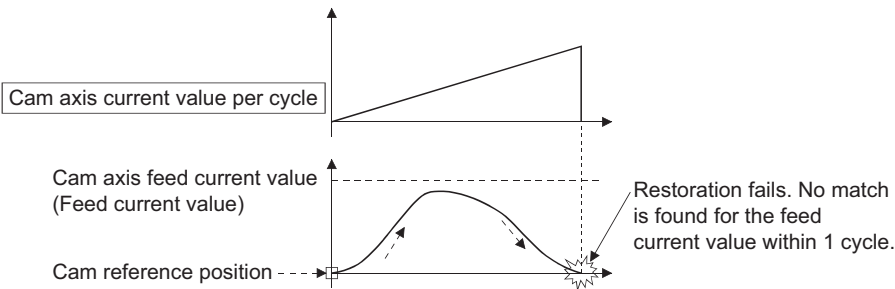

- The search fails. (Pattern 2)

When the cam axis current value per cycle restoration is executed in a cam stroke range that straddles 0 [degree]

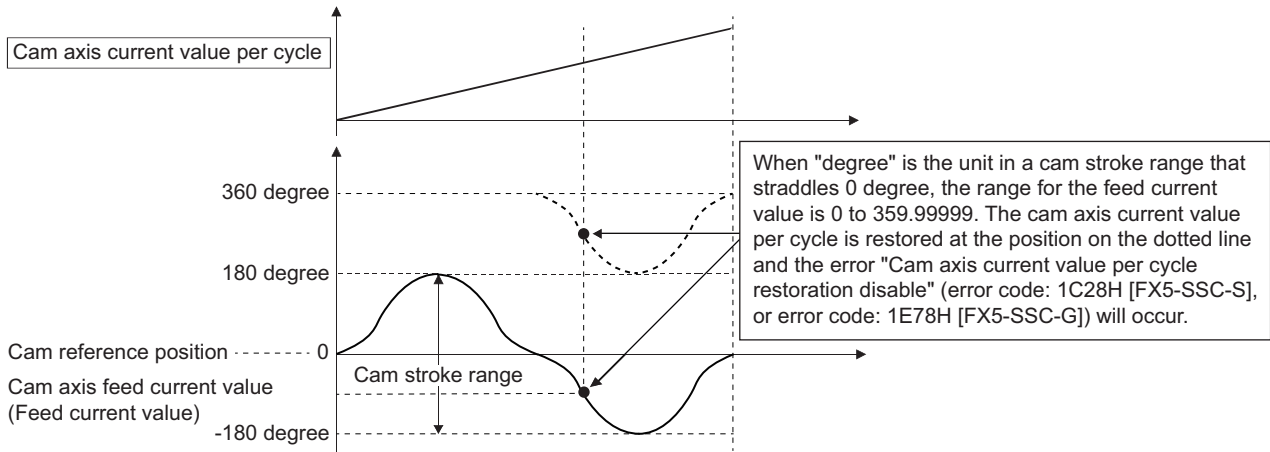

Execute cam axis current value per cycle restoration within a cam stroke range exceeding 0 and less than 360 [degree].

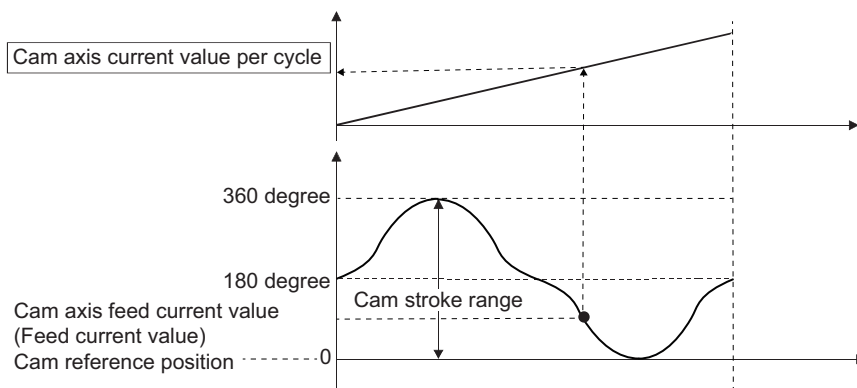

### ■ With a feed operation cam pattern

- Search from "Cam axis current value per cycle = 0". (Cam data starting point = 0)

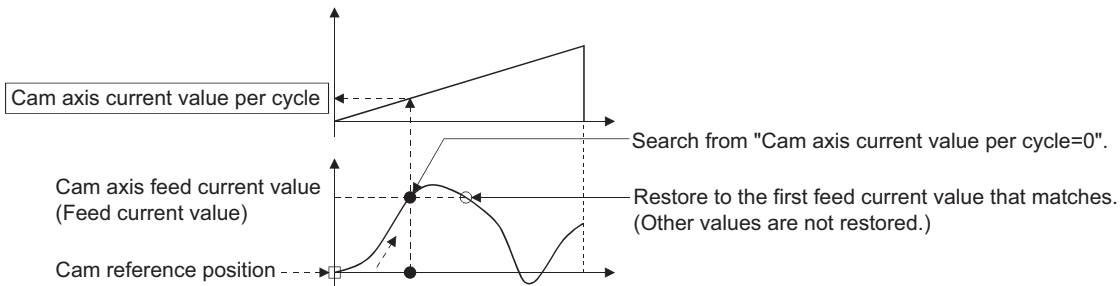

- Search from a value in the middle of the cam axis current value per cycle. (Cam data starting point = 0)

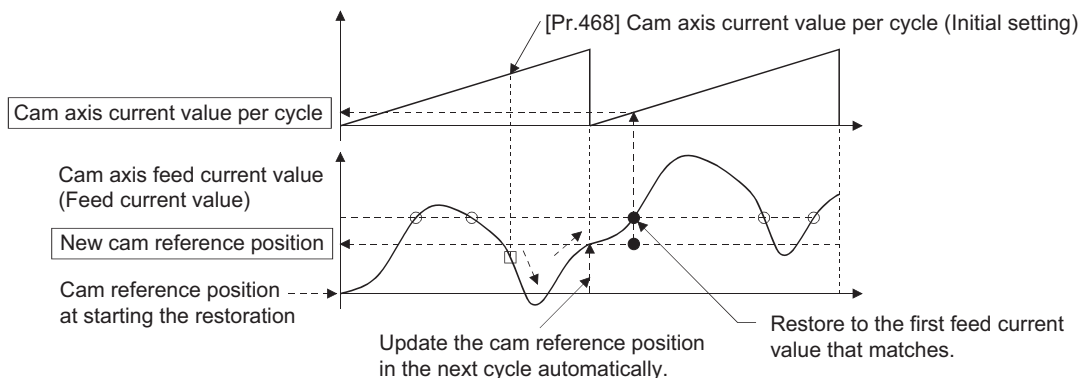

- Search from a value in the middle of the cam axis current value per cycle. (Cam data starting point ≠ 0)

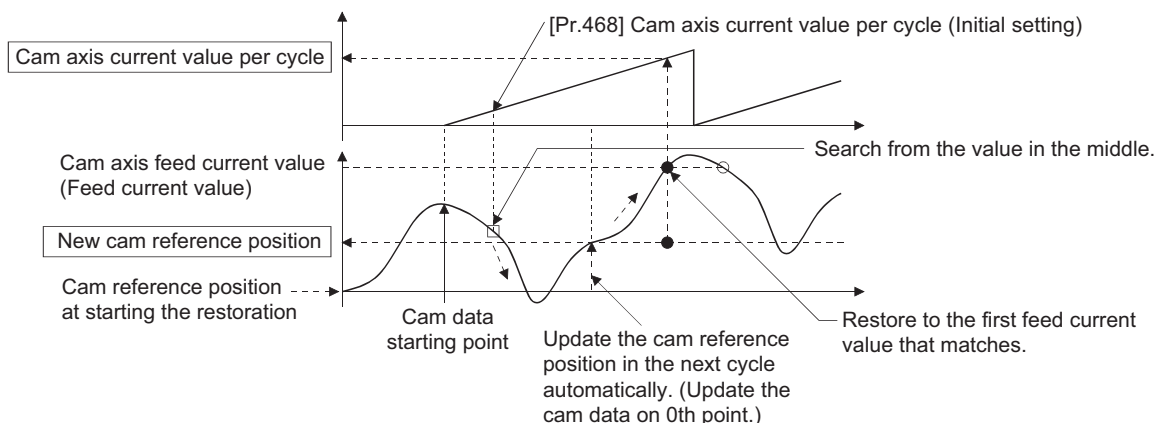

- The first search is fails and a search begins for the second time.

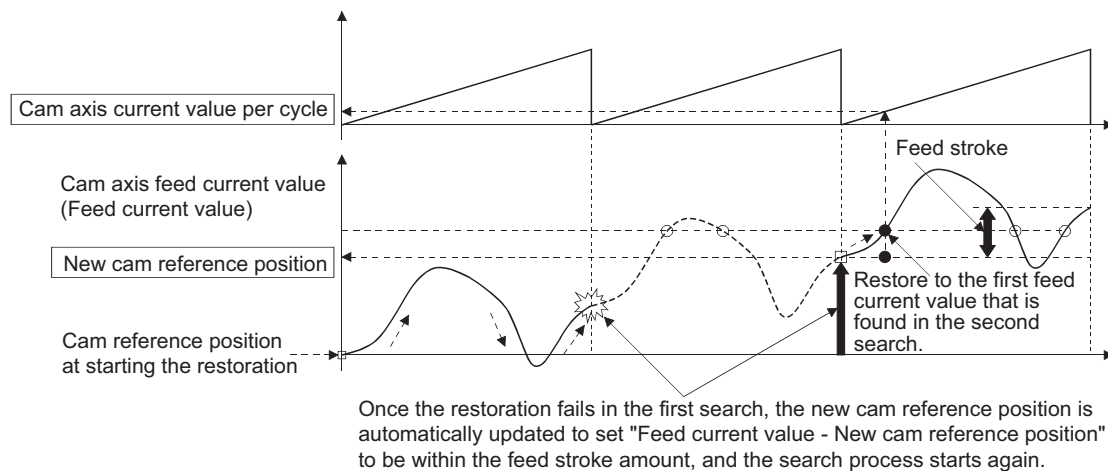



**Point**

If the first search fails, a second search may not be processed on the next cycle for a cam pattern with a feed stroke that is smaller than 100% of the stroke as above.

The intended cam axis current value per cycle can be found in the first search, by setting or positioning the cam reference position in advance.

## Example

The following shows an example of restarting the cam (a cam similar to a cam with a linear feed where two identical positioning points do not exist on the cam) from the feed current value after a forced stop, when the forced stop has stopped operation.

If the following settings are used in a two-way cam or a cam where identical positioning points exist on the same cam, similar to the cam axis current value per cycle restoration operation (  Page 151 Cam axis current value per cycle restoration operation), the first matching feed current value (outward route) is restored, therefore restoration may start from an unintended cam pattern position. To avoid restoring the first matching feed current value, use cam axis feed current value restoration (  Page 157 Cam axis feed current value restoration).

Setting item	Setting value
[Pr.439] Cam axis length per cycle	1000 [pulse]
[Pr.441] Cam stroke amount	200 [pulse]
[Pr.462] Cam axis position restoration object	0: Cam axis current value per cycle restoration
[Pr.463] Setting method of cam reference position	1: Initial setting value of cam reference position
[Pr.464] Setting method of cam axis current value per cycle	0: Previous value
[Pr.467] Cam reference position (Initial setting)	0 [pulse]
[Pr.468] Cam axis current value per cycle (Initial setting)	0 [pulse]

### • Advanced synchronous control operation

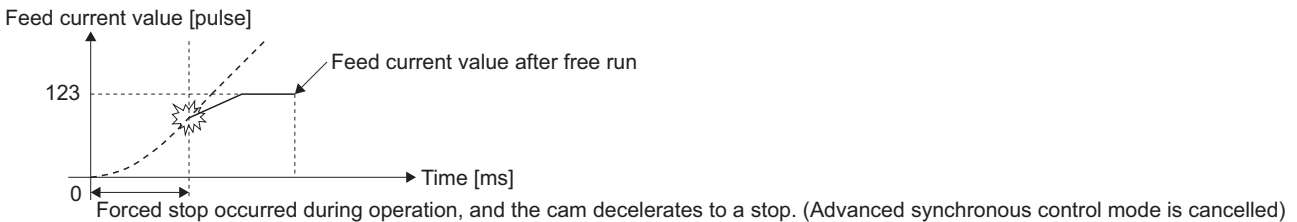

### • Restore operation at restart of advanced synchronous control

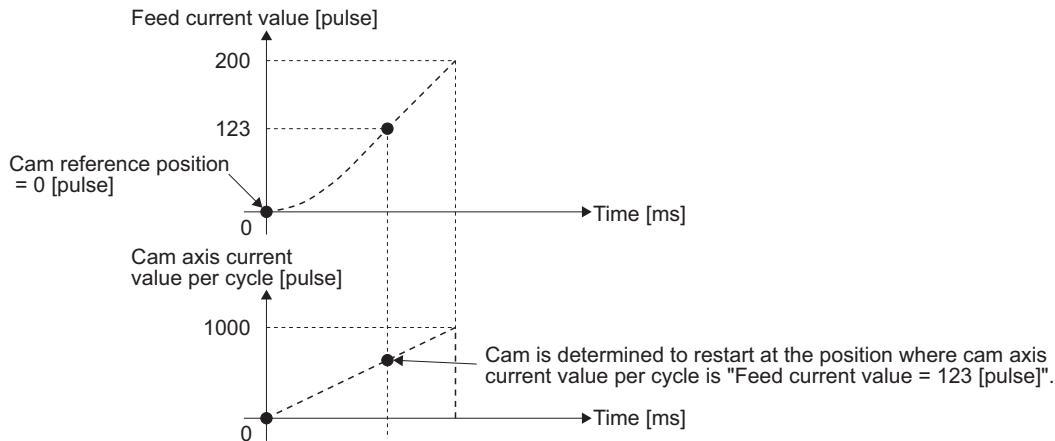

### • Cam operation

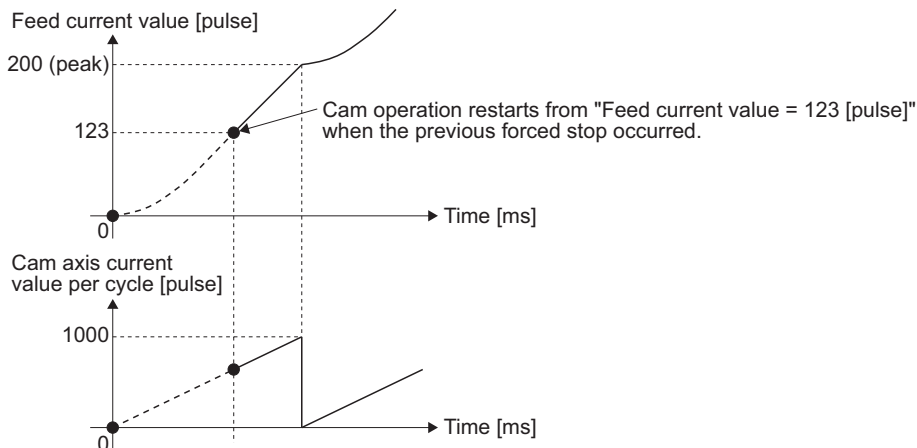

# Cam reference position restoration

If "[Pr.462] Cam axis position restoration object" is set to "1: cam reference position restoration" when starting synchronous control, the cam reference position is restored based on the cam axis current value per cycle and the cam axis feed current value.

Select the method for the cam axis current value per cycle to be restored. The feed current value when starting synchronous control is used as the cam axis feed current value.

[Pr.464] Setting method of cam axis current value per cycle

- 0: Previous value
- 1: Initial setting value of cam axis current value per cycle
- 2: Current value per cycle after main shaft gear
- 3: Current value per cycle after auxiliary shaft gear

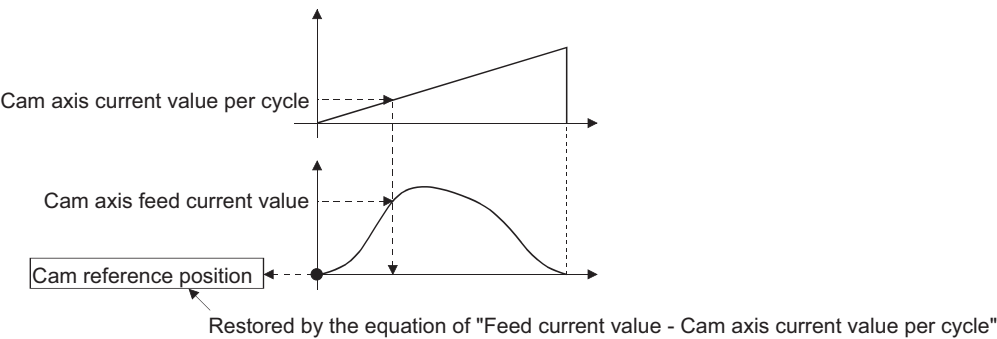
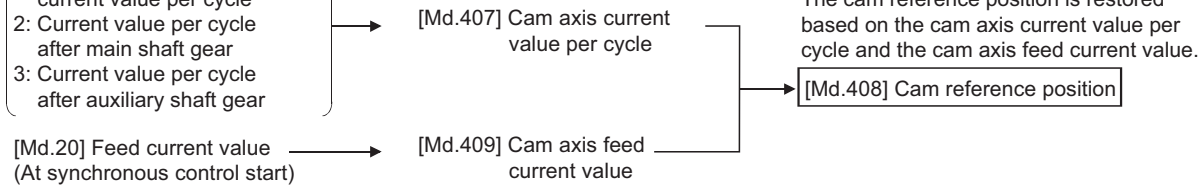

## Example

The following shows an example of starting operation from a position of "cam axis current value per cycle=0" by restoring the cam reference position when starting from "feed current value=0 [pulse]", in the cam when the cam data starting point is not 0.

Setting item	Setting value
[Pr.439] Cam axis length per cycle	1000 [pulse]
[Pr.441] Cam stroke amount	200 [pulse]
[Pr.462] Cam axis position restoration object	1: Cam reference position restoration
[Pr.463] Setting method of cam reference position	None
[Pr.464] Setting method of cam axis current value per cycle	1: Initial setting value of cam axis current value per cycle
[Pr.467] Cam reference position (Initial setting)	None
[Pr.468] Cam axis current value per cycle (Initial setting)	0 [pulse]

- Operation before starting advanced synchronous control

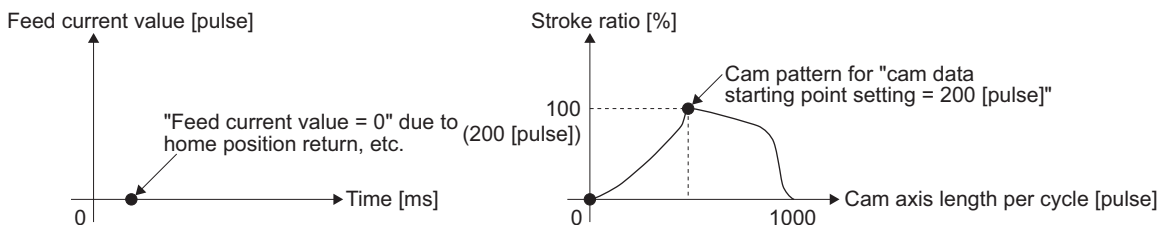

- Restore operation at start of advanced synchronous control

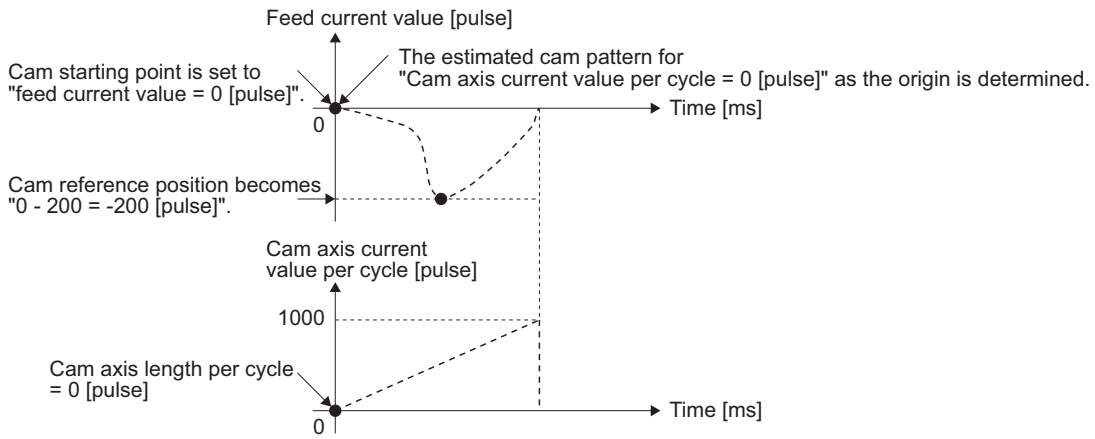

- Cam operation

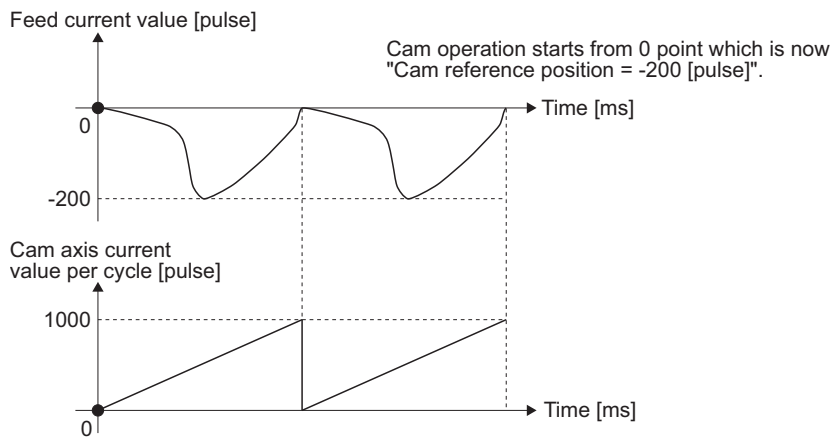

# Cam axis feed current value restoration

If "[Pr.462] Cam axis position restoration object" is set to "2: Cam axis feed current value restoration" when starting synchronous control, the cam axis feed current value is restored based on the cam axis current value per cycle and the cam reference position.

Select the method for the cam axis current value per cycle and the method for the cam reference position to be restored.

[Pr.464] Setting method of cam axis current value per cycle

- 0: Previous value
- 1: Initial setting value of cam axis current value per cycle
- 2: Current value per cycle after main shaft gear
- 3: Current value per cycle after auxiliary shaft gear

[Md.407] Cam axis current value per cycle

The cam axis feed current value is restored based on the cam axis current value per cycle and the cam reference position.

[Pr.463] Setting method of cam reference position

- 0: Previous value
- 1: Initial setting value of cam reference position
- 2: Feed current value

[Md.408] Cam reference position

[Md.409] Cam axis feed current value

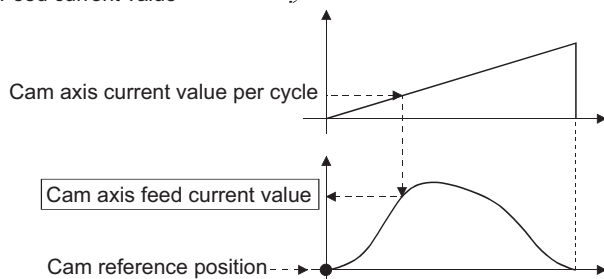

## Restriction

The cam axis feed current value moves to its restored value just after starting synchronous control when the cam axis feed current value to be restored is different from the feed current value at synchronous control start. If the difference is larger than "In-position width (PA10)" of servo amplifier in pulse command units, the error "Cam axis feed current value restoration disable" (error code: 1C29H [FX5-SSC-S], or error code: 1E79H [FX5-SSC-G]) will occur and synchronous control cannot be started.

Note that, if the setting value of "In-position width" is large, a rapid operation may occur.

## Point

With cam axis feed current value restoration, calculate the cam axis feed current value with the cam position calculation function (Page 161 Cam Position Calculation Function) or with synchronous control analysis mode (Page 159 Synchronous Control Analysis Mode) before starting synchronous control. Then start synchronous control after positioning to the correct cam axis feed current value.

## Example

The following shows an example of starting a cam pattern from the zero point of the cam axis current value per cycle with the current feed current value position as the origin when returning to a specified point, or home position return is completed after a forced stop.

Setting item	Setting value
[Pr.439] Cam axis length per cycle	1000 [pulse]
[Pr.441] Cam stroke amount	200 [pulse]
[Pr.462] Cam axis position restoration object	2: Cam axis feed current value restoration
[Pr.463] Setting method of cam reference position	2: Feed current value
[Pr.464] Setting method of cam axis current value per cycle	1: Initial setting value of cam axis current value per cycle
[Pr.467] Cam reference position (Initial setting)	None
[Pr.468] Cam axis current value per cycle (Initial setting)	0 [pulse]

- Move to advanced synchronous control starting point

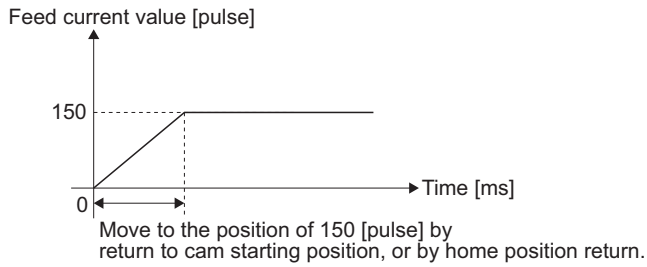

- Restore operation

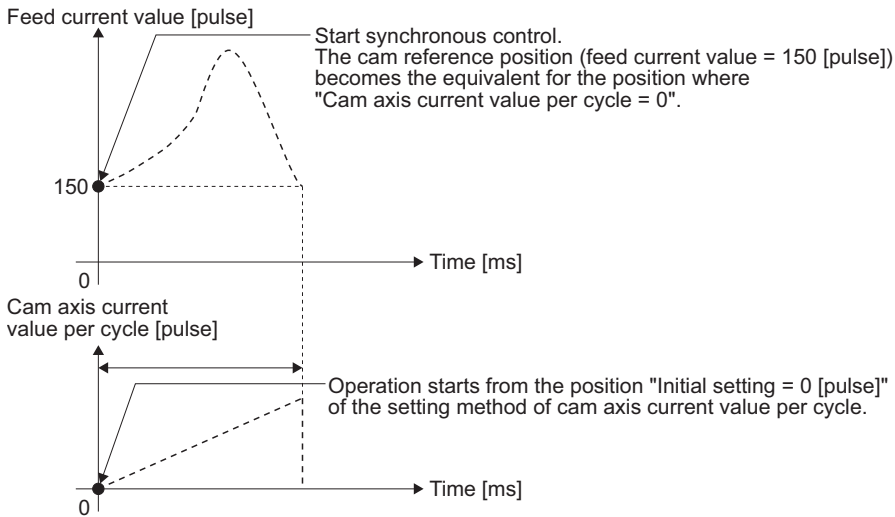

- Cam operation

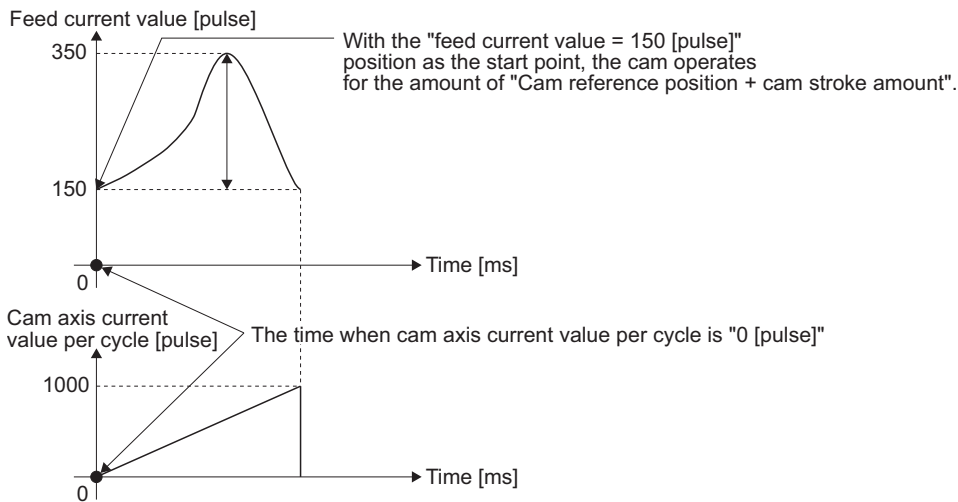



# 5.4 Synchronous Control Analysis Mode

With synchronous control analysis mode, advanced synchronous control parameters are only analyzed when there is a command to start synchronous control. This mode is used to confirm the synchronous positions of the output axes in order to align axes with position control before starting synchronous control.

If the target axis bit is ON in "[Cd.381] Synchronous control analysis mode" when starting synchronous control (turning the target axis bit from OFF to ON for "[Cd.380] Synchronous control start"), operation enters synchronous control analysis mode.

When the synchronization position analysis is completed, the synchronous control monitor data ([Md.400] to [Md.425]) is updated, and the target axis bit in "[Cd.380] Synchronous control start" turns OFF.

"[Md.141] BUSY" is not turned ON during synchronous control analysis mode.

When starting synchronous control with synchronous control analysis mode, the following error does not occur.

- Cam axis feed current value restoration disable (error code: 1C29H [FX5-SSC-S], or error code: 1E79H [FX5-SSC-G])

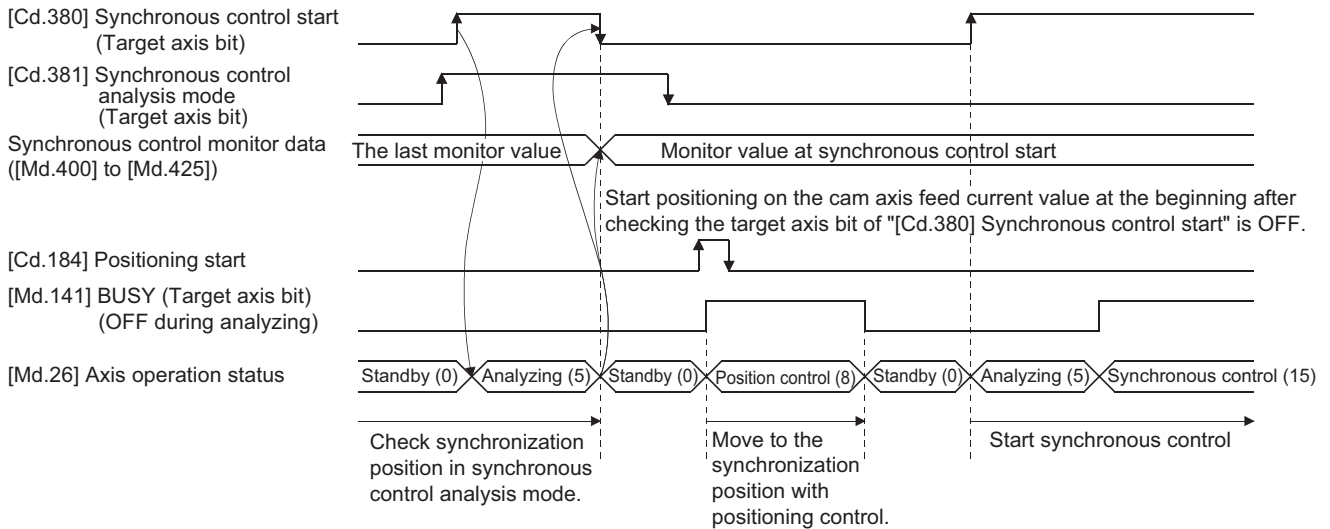

## Synchronous control system control data

Setting item	Setting details	Setting value	Default value	Buffer memory address
[Cd.380] Synchronous control start	<ul style="list-style-type: none"> <li>• Synchronous control begins if the target axis bit is turned ON.</li> <li>• Synchronous control ends if the bit is turned OFF during synchronous control.</li> </ul> Fetch cycle: Operation cycle	■Set the target axis in 16 bits. (bit0: axis 1 to bit7: axis 8 <sup>*1</sup> ) OFF: Synchronous control end ON: Synchronous control start	0	36320
[Cd.381] Synchronous control analysis mode	<ul style="list-style-type: none"> <li>• If the target axis bit is turned ON and synchronous control is started, the analysis is only executed and the control does not start.</li> </ul> Fetch cycle: At start of synchronous control	■Set the target axis in 16 bits. (bit0: axis 1 to bit7: axis 8 <sup>*1</sup> ) OFF: Synchronous control analysis mode OFF ON: Synchronous control analysis mode ON	0	36322

\*1 The range from axis 1 to 4 is valid in the 4-axis module and from axis 1 to 8 is valid in the 8-axis module.

## Example

The following shows a procedure of aligning the synchronous position of an output axis that references the input axis.

1. Set the following values in the synchronous control initial position parameters.

Setting item	Setting value
[Pr.460] Setting method of current value per cycle after main shaft gear	2: Calculate from input axis
[Pr.462] Cam axis position restoration object	2: Cam axis feed current value restoration
[Pr.463] Setting method of cam reference position	0: Previous value
[Pr.464] Setting method of cam axis current value per cycle	2: Current value per cycle after main shaft gear

2. Turn ON the target axis bit of "[Cd.381] Synchronous control analysis mode", and then turn the target axis bit from OFF to ON in "[Cd.380] Synchronous control start" to start the synchronous control analysis mode.
3. Verify the target axis bit is OFF for "[Cd.380] Synchronous control start", and execute positioning for the output axis to be updated to "[Md.409] Cam axis feed current value".
4. Turn OFF the target axis bit of "[Cd.381] Synchronous control analysis mode", and then turn the target axis bit from OFF to ON in "[Cd.380] Synchronous control start" to start synchronous control.

# 5.5 Cam Position Calculation Function

The cam position is calculated by the program with this function. This function can be used to calculate the cam position for the synchronous control initial position before starting synchronous control.

## Example

The following shows the procedure for synchronous position alignment, in a synchronous system where cam axes 2 and 3 are synchronized with the cam axis current value per cycle of axis 1.

1. Calculate the cam axis current value per cycle using this function based on the feed current value and the cam reference position of axis 1.
2. Calculate the cam axis feed current value of axis 2 with this function based on the cam axis current value per cycle that was calculated in 1).
3. Calculate the cam axis feed current value of axis 3 with this function based on the cam axis current value per cycle that was calculated in 1).
4. Execute positioning on axis 2 to the cam axis feed current value which was calculated in 2), and also on axis 3 to the cam axis feed current value which was calculated in 3).
5. Start synchronous control on axis 1, 2 and 3 with the feed current value restoration mode. Use the cam axis current value per cycle that was calculated in 1) for the cam axis current value per cycle (Initial setting).

## Cam position calculation control data

Setting item	Setting details	Setting value	Default value	Buffer memory address
[Cd.612] Cam position calculation request	<ul style="list-style-type: none"> <li>Set the cam position calculation request.</li> <li>The Simple Motion module/Motion module resets the value to "0" automatically after completion of the cam position calculation.</li> </ul> Fetch cycle: Main cycle*1	■Set in decimal. 1: Cam axis feed current value calculation request 2: Cam axis current value per cycle calculation request	0	53780
[Cd.613] Cam position calculation: Cam No.	<ul style="list-style-type: none"> <li>Set the cam No. for the cam position calculation.</li> </ul> Fetch cycle: At requesting cam position calculation	■Set in decimal. 0 to 256	0	53781
[Cd.614] Cam position calculation: Stroke amount	<ul style="list-style-type: none"> <li>Set the cam stroke amount for the cam position calculation.</li> </ul> Fetch cycle: At requesting cam position calculation	■Set in decimal. -2147483648 to 2147483647 [Output axis position units*2]	0	53782 53783
[Cd.615] Cam position calculation: Cam axis length per cycle	<ul style="list-style-type: none"> <li>Set the cam axis length per cycle for the cam position calculation.</li> </ul> Fetch cycle: At requesting cam position calculation	■Set in decimal. 1 to 2147483647 [Cam axis cycle units*3]	0	53784 53785
[Cd.616] Cam position calculation: Cam reference position	<ul style="list-style-type: none"> <li>Set the cam reference position for the cam position calculation.</li> </ul> Fetch cycle: At requesting cam position calculation	■Set in decimal. -2147483648 to 2147483647 [Output axis position units*2]	0	53786 53787
[Cd.617] Cam position calculation: Cam axis current value per cycle	<ul style="list-style-type: none"> <li>Set the cam axis current value per cycle for the cam position calculation.</li> </ul> Fetch cycle: At requesting cam position calculation	■Set in decimal. 0 to (Cam axis length per cycle) [Cam axis cycle units*3]	0	53788 53789
[Cd.618] Cam position calculation: Cam axis feed current value	<ul style="list-style-type: none"> <li>Set the cam axis feed current value for the cam position calculation. (Set when calculating the cam axis current value per cycle.)</li> </ul> Fetch cycle: At requesting cam position calculation	■Set in decimal. -2147483648 to 2147483647 [Output axis position units*2]	0	53790 53791

\*1 With the exception of positioning control, main cycle processing is executed during the next available time. It changes by status of axis start.

\*2 Output axis position units (↖ Page 127 Units for the output axis)

\*3 Cam axis cycle units (↖ Page 127 Units for the output axis)

## [Cd.612] Cam position calculation request

Set the following commands to calculate the cam position.

Setting value	Details
1	Cam axis feed current value calculation request
2	Cam axis current value per cycle calculation request

The result is stored in "[Md.600] Cam position calculation result" and the setting value is reset to "0" automatically after completion of cam position calculation.

If warnings occur when requesting the cam position calculation, the warning No. is stored in "[Md.24] Axis warning No." of axis 1 and the setting value is reset to "0" automatically.

When a value other than the request command values listed above is set, this calculation does not get executed and the setting value is reset to "0" automatically.

## [Cd.613] Cam position calculation: Cam No.

Set the cam No. for the cam position calculation. If 0 is set for the cam No., the cam position is calculated as a linear cam.

## [Cd.614] Cam position calculation: Stroke amount

Set the cam stroke amount for the cam position calculation.

## [Cd.615] Cam position calculation: Cam axis length per cycle

Set the cam axis length per cycle for the cam position calculation.

## [Cd.616] Cam position calculation: Cam reference position

Set the cam reference position for the cam position calculation.

## [Cd.617] Cam position calculation: Cam axis current value per cycle

Set the cam axis current value per cycle for the cam position calculation when calculating the cam axis feed current value.

Set the cam axis current value per cycle as the starting point to search when calculating the cam axis current value per cycle and the cam position.

## [Cd.618] Cam position calculation: Cam axis feed current value

Set the cam axis feed current value for the cam position calculation when calculating the cam axis current value per cycle.

This is not used when calculating the cam axis feed current value.

# Cam position calculation monitor data

Monitor item	Storage details	Monitor value	Buffer memory address
[Md.600] Cam position calculation result	<ul style="list-style-type: none"> <li>The result of the cam position calculation is stored.</li> </ul> <u>Refresh cycle: At cam position calculation completion</u>	<ul style="list-style-type: none"> <li>Monitoring is carried out in decimal.</li> <li>When calculating the cam axis feed current value: -2147483648 to 2147483647 [Output axis position units<sup>*1</sup>]</li> <li>When calculating the cam axis current value per cycle: 0 to (Cam axis length per cycle - 1) [Cam axis cycle units<sup>*2</sup>]</li> </ul>	53800 53801

\*1 Output axis position units (Page 127 Units for the output axis)

\*2 Cam axis cycle units (Page 127 Units for the output axis)

## [Md.600] Cam position calculation result

The result of the cam position calculation is stored.

Cam position calculation	Storage details
When calculating the cam axis feed current value	Calculated value of the cam axis feed current value is stored.
When calculating the cam axis current value per cycle	Calculated value of the cam axis current value per cycle is stored. The cam reference position is not updated automatically by the cam position calculation function.

## Search for the cam axis current value per cycle

When calculating the cam axis current value per cycle using cam data, the position corresponding to "[Cd.618] Cam position calculation: Cam axis feed current value" is searched using cam data based on the position specified by "[Cd.617] Cam position calculation: Cam axis current value per cycle".

The following shows the order of the search for "[Cd.618] Cam position calculation: Cam axis feed current value".

## ■ Stroke ratio data format

When "the nth point of cam data  $\leq$  [Cd.617] Cam position calculation: Cam axis current value per cycle < the n + 1st point of cam data", the position corresponding to "[Cd.618] Cam position calculation: Cam axis feed current value" is searched from the nth point of cam data.

If "[Cd.617] Cam position calculation: Cam axis current value per cycle" is in the middle of the cam data and the corresponding position is not found until the last point of the cam data, return to the 0th point and search until the search starting point.

If the corresponding position is not found even though the whole area of the cam data has been searched, the warning "Cam position calculation cam axis 1 cycle current value calculation disable" (warning code: 0C64H [FX5-SSC-S], or warning code: 0EB4H [FX5-SSC-G]) will occur in reciprocated cam pattern.

For the feed cam, calculates "[Cd.618] Cam position calculation: Cam axis feed current value" by the stroke difference and searches again from the 0th point to the whole range. If the corresponding position is not found even though the search process starts again, the warning "Cam position calculation cam axis 1 cycle current value calculation disable" (warning code: 0C64H [FX5-SSC-S], or warning code: 0EB4H [FX5-SSC-G]) will occur.

**Ex.**

When "[Cd.617] Cam position calculation: Cam axis current value per cycle" is corresponding to the 0th point of cam data

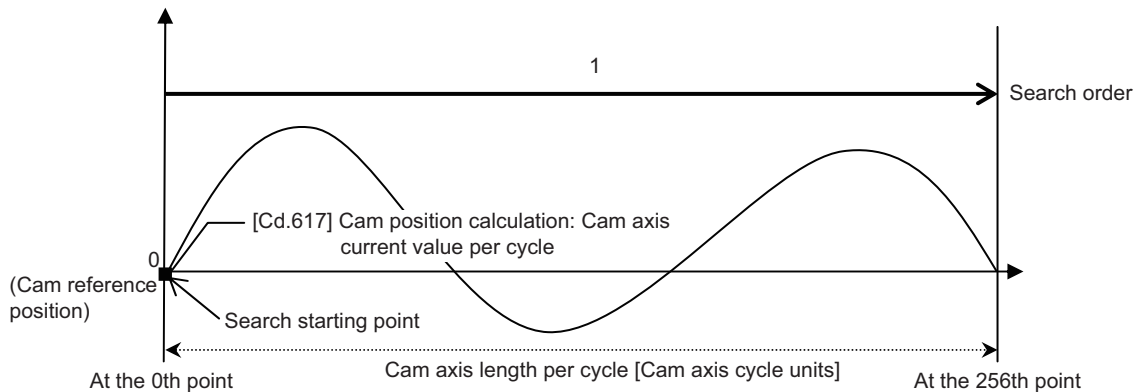

- Searches until between the 255th point and the 256th point (last point) in order of the cam data between the 0th point and the 1st point and between the 1st point and the 2nd point.

**Ex.**

When "[Cd.617] Cam position calculation: Cam axis current value per cycle" is corresponding to the 128th point of cam data

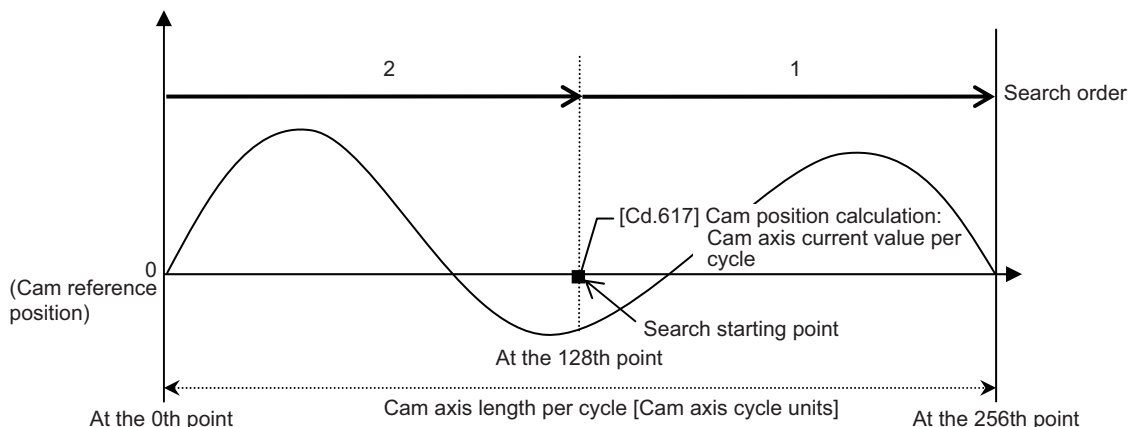

- Searches until between the 255th point and the 256th point (last point) in order of the cam data between the 128th point and the 129th point and between the 130th point and the 131th point.
- If the corresponding position is not found until the last point of the cam data, searches from the 0th point of the cam data.
- Searches until between the 127th point and the 128th point in order of the cam data between the 0th point and the 1st point and between the 1st point and the 2nd point.

## Coordinate data format

(1) The range before the 1st point of cam data

When the 1st point of the cam data is larger than 0 and "[Cd.617] Cam position calculation: Cam axis current value per cycle < the 1st point of cam data", the position corresponding to "[Cd.618] Cam position calculation: Cam axis feed current value" is searched from the range before the 1st point of the cam data.

If the corresponding position is not found in the range of (1), searches in the range of (2). If the corresponding position is not found in the range of (2) either, searches in the range of (3).

If the corresponding position is not found even though the range of (1) to (3) has been searched, the warning "Cam position calculation cam axis 1 cycle current value calculation disable" (warning code: 0C64H [FX5-SSC-S], or warning code: 0EB4H [FX5-SSC-G]) will occur in reciprocated cam pattern.

For the feed cam, calculates "[Cd.618] Cam position calculation: Cam axis feed current value" by the stroke difference and searches again from the 0th point to the whole range. If the corresponding position is not found even though the search process starts again, the warning "Cam position calculation cam axis 1 cycle current value calculation disable" (warning code: 0C64H [FX5-SSC-S], or warning code: 0EB4H [FX5-SSC-G]) will occur.

**Ex.**

When "[Cd.617] Cam position calculation: Cam axis current value per cycle" is set before the 1st point of cam data

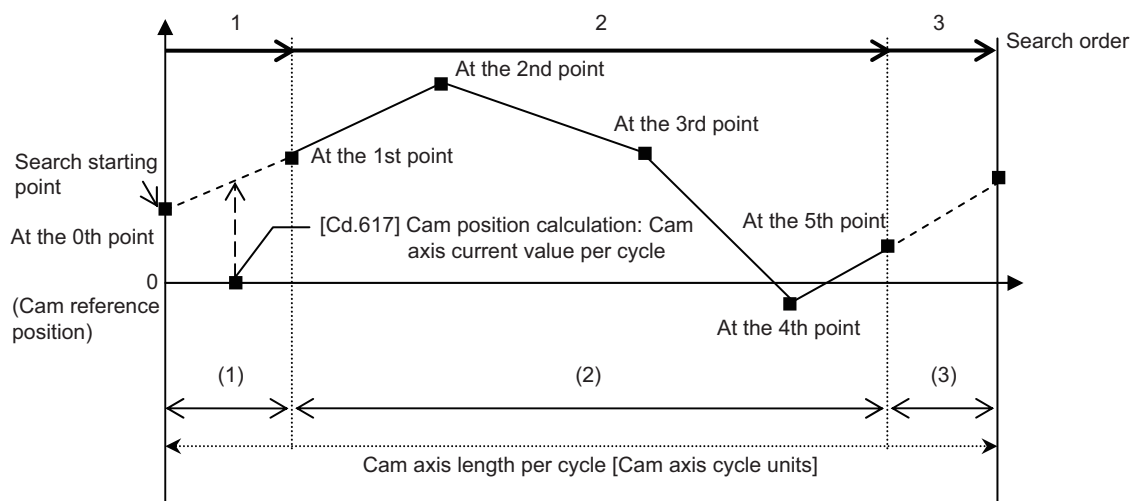

- Searches from the range of (1).
  - If the corresponding position is not found in the range of (1), searches from the 1st point of the cam data in the range of (2).
- (2) The range within the cam data

When "[Cd.617] Cam position calculation: Cam axis current value per cycle < the last point of cam data", the position corresponding to "[Cd.618] Cam position calculation: Cam axis feed current value" is searched from the range of the cam data.

When "the nth point of cam data  $\leq$  [Cd.617] Cam position calculation: Cam axis current value per cycle < the n + 1st point of cam data", the position corresponding to "[Cd.618] Cam position calculation: Cam axis feed current value" is searched from the nth point of cam data.

If "[Cd.617] Cam position calculation: Cam axis current value per cycle" is in the middle of the cam data and the corresponding position is not found until the last point of the cam data, returns to the 1st point and searches until the search starting point.

If the corresponding position is not found in the range of (2), searches in the range of (3).

If the corresponding position is not found even though the range of (2) and (3) has been searched, the warning "Cam position calculation cam axis 1 cycle current value calculation disable" (warning code: 0C64H [FX5-SSC-S], or warning code: 0EB4H [FX5-SSC-G]) will occur in reciprocated cam pattern.

For the feed cam, calculates "[Cd.618] Cam position calculation: Cam axis feed current value" by the stroke difference and searches again from the 0th point to the whole range. If the corresponding position is not found even though the search process starts again, the warning "Cam position calculation cam axis 1 cycle current value calculation disable" (warning code: 0C64H [FX5-SSC-S], or warning code: 0EB4H [FX5-SSC-G]) will occur.

Ex.

When "[Cd.617] Cam position calculation: Cam axis current value per cycle" is corresponding to the 1st point of cam data

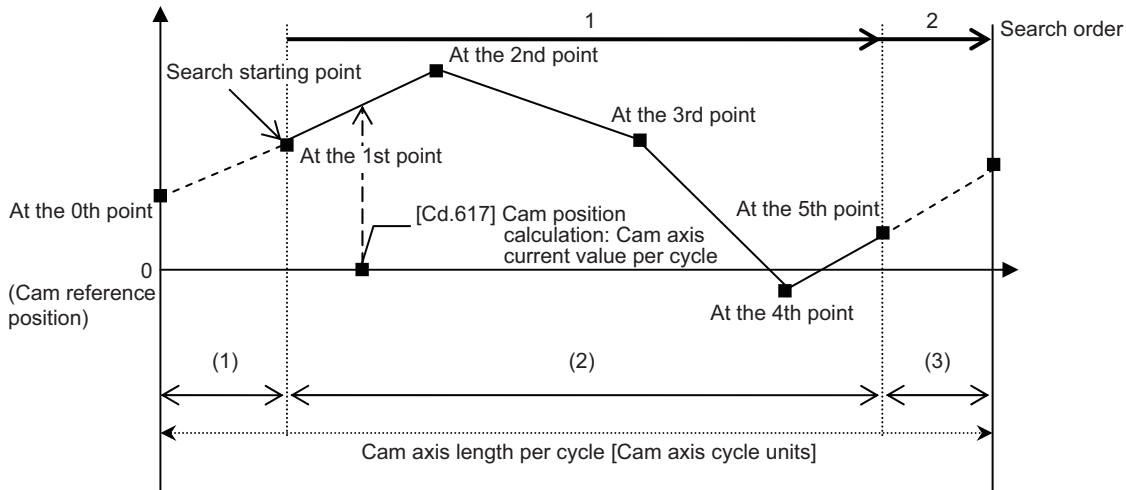

- Searches until between the 4th point and the 5th point (last point) in order of the cam data between the 1st point and the 2nd point and between the 2nd point and the 3rd point.
- If the corresponding position is not found until the last point of the cam data, searches from the range of (3).

Ex.

When "[Cd.617] Cam position calculation: Cam axis current value per cycle" is corresponding to the 3rd point of cam data

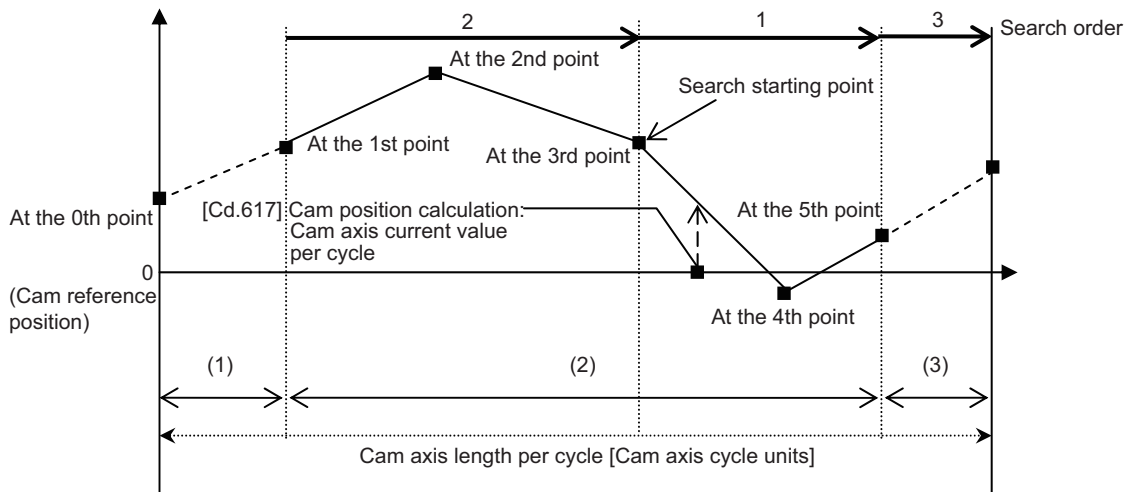

- Searches in order of the cam data between the 3rd point and the 4th point and between the 4th point and the 5th point (last point).
- If the corresponding position is not found until the last point of the cam data, searches from the 1st point of the cam data.
- If the corresponding position is not found in the cam data between the 1st point and the 2nd point and between the 2nd point and the 3rd point, searches from the range of (3).



(3) The range from the last point of cam data to the cam axis length per cycle

When "the last point of cam data  $\leq$  [Cd.617] Cam position calculation: Cam axis current value per cycle < cam axis length per cycle", the position corresponding to "[Cd.618] Cam position calculation: Cam axis feed current value" is searched from the last point of the cam data or later.

If the corresponding position is not found even though the range of (3) has been searched, the warning "Cam position calculation cam axis 1 cycle current value calculation disable" (warning code: 0C64H [FX5-SSC-S], or warning code: 0EB4H [FX5-SSC-G]) will occur in reciprocated cam pattern.

For the feed cam, calculates "[Cd.618] Cam position calculation: Cam axis feed current value" by the stroke difference and searches again from the 0th point to the whole range. If the corresponding position is not found even though the search process starts again, the warning "Cam position calculation cam axis 1 cycle current value calculation disable" (warning code: 0C64H [FX5-SSC-S], or warning code: 0EB4H [FX5-SSC-G]) will occur.

**Ex.**

When "[Cd.617] Cam position calculation: Cam axis current value per cycle" is corresponding to the last point of cam data

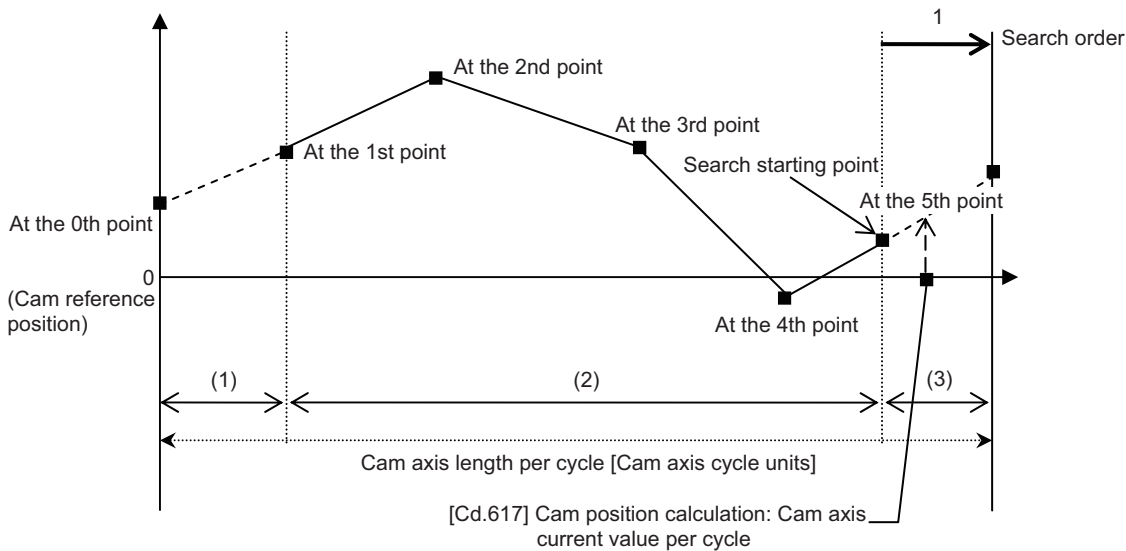

- Searches from the range of (3).

## 5.6 Method to Restart Synchronous Control

The relationship of the synchronous position for synchronous control is always saved in the Simple Motion module/Motion module. Synchronous control can be restarted without returning all axes to their starting points by restoring the synchronized relationship through the synchronous control initial position parameters (  Page 146 Synchronous Control Initial Position Parameters).

The reference axis used to restart synchronous control is different for each system. The following procedure shows an example of how to restore synchronized values based on the servo input axis as reference position.

### Example

Restoring 2 output axes (axis 2, axis 3) based on the servo input axis (axis 1) as the reference position. (Press conveyance device)

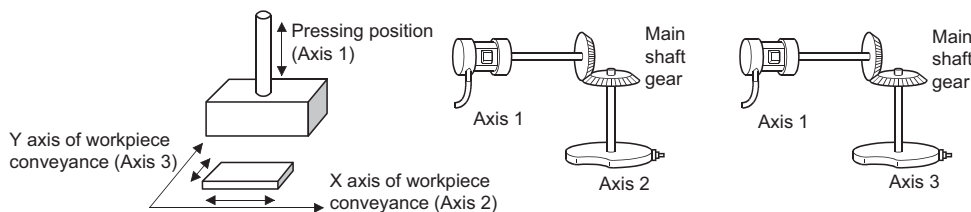

#### ■Procedure for synchronous control (first time)

1. Execute home position return for axis 1, 2 and 3, and position to the synchronization starting point.
2. Set the synchronous control initial position parameters for axis 2 and 3 as follows.

Setting item	Setting value
[Pr.460] Setting method of current value per cycle after main shaft gear	2: Calculate from input axis
[Pr.462] Cam axis position restoration object	0: Cam axis current value per cycle restoration
[Pr.463] Setting method of cam reference position	2: Feed current value
[Pr.468] Cam axis current value per cycle (Initial setting)	0

3. Turn ON the bits for axis 2 and 3 in "[Cd.380] Synchronous control start" to start synchronous control.

#### ■Procedure for restarting synchronous control

1. Set the synchronous control initial position parameters for axis 2 and 3 as follows.

Setting item	Setting value
[Pr.460] Setting method of current value per cycle after main shaft gear	2: Calculate from input axis
[Pr.462] Cam axis position restoration object	2: Cam axis feed current value restoration
[Pr.463] Setting method of cam reference position	0: Previous value
[Pr.464] Setting method of cam axis current value per cycle	2: Current value per cycle after main shaft gear

2. Turn ON the bits for axes 2 and 3 in "[Cd.381] Synchronous control analysis mode", and then turn ON the bits for axes 2 and 3 in "[Cd.380] Synchronous control start" to execute the synchronous control analysis. The analyzed result is updated in [Md.400] to [Md.425].
3. Position axes 2 and 3 to "[Md.409] Cam axis feed current value" which has been updated in 2.
4. Turn OFF the bits for axes 2 and 3 in "[Cd.381] Synchronous control analysis mode", and then turn ON the bits for axes 2 and 3 in "[Cd.380] Synchronous control start" to start synchronous control.

# APPENDICES

## Appendix 1 List of Buffer Memory Addresses (for Synchronous Control)

The following shows the relation between the buffer memory addresses and the various items.

Refer to "List of Buffer Memory Addresses" in the following manual for the list of general buffer memory addresses.

📖 MELSEC iQ-F FX5 Motion Module/Simple Motion Module User's Manual (Application)

### Parameters

#### ■ Servo input axis parameters

n: Axis No. - 1

Item	Buffer memory address
[Pr.300] Servo input axis type	32800+10n
[Pr.301] Servo input axis smoothing time constant	32801+10n
[Pr.302] Servo input axis phase compensation advance time	32802+10n 32803+10n
[Pr.303] Servo input axis phase compensation time constant	32804+10n
[Pr.304] Servo input axis rotation direction restriction	32805+10n

#### ■ Synchronous encoder axis parameters

j: Synchronous encoder axis No. - 1

Item	Buffer memory address
[Pr.320] Synchronous encoder axis type	34720+20j
[Pr.321] Synchronous encoder axis unit setting	34721+20j
[Pr.322] Synchronous encoder axis unit conversion: Numerator	34722+20j 34723+20j
[Pr.323] Synchronous encoder axis unit conversion: Denominator	34724+20j 34725+20j
[Pr.324] Synchronous encoder axis length per cycle	34726+20j 34727+20j
[Pr.325] Synchronous encoder axis smoothing time constant	34728+20j
[Pr.326] Synchronous encoder axis phase compensation advance time	34730+20j 34731+20j
[Pr.327] Synchronous encoder axis phase compensation time constant	34732+20j
[Pr.328] Synchronous encoder axis rotation direction restriction	34733+20j
[Pr.329] Resolution of synchronous encoder via CPU	34734+20j 34735+20j

#### ■ Command generation axis parameters

Item	Buffer memory address
[Pr.340] Command generation axis valid setting	—*1
[Pr.346] Command generation axis length per cycle	—*1

\*1 It is not in the buffer memory. Refer to the following.

📖 Page 38 Command generation axis parameters

A

## ■Synchronous parameters: Main shaft

n: Axis No. - 1

Item	Buffer memory address
[Pr.400] Main input axis No.	36400+200n
[Pr.401] Sub input axis No.	36401+200n
[Pr.402] Composite main shaft gear	36402+200n
[Pr.403] Main shaft gear: Numerator	36404+200n 36405+200n
[Pr.404] Main shaft gear: Denominator	36406+200n 36407+200n
[Pr.405] Main shaft clutch control setting	36408+200n
[Pr.406] Main shaft clutch reference address setting	36409+200n
[Pr.407] Main shaft clutch ON address	36410+200n 36411+200n
[Pr.408] Movement amount before main shaft clutch ON	36412+200n 36413+200n
[Pr.409] Main shaft clutch OFF address	36414+200n 36415+200n
[Pr.410] Movement amount before main shaft clutch OFF	36416+200n 36417+200n
[Pr.411] Main shaft clutch smoothing method	36418+200n
[Pr.412] Main shaft clutch smoothing time constant	36419+200n
[Pr.413] Slippage at main shaft clutch ON	36420+200n 36421+200n
[Pr.414] Slippage at main shaft clutch OFF	36422+200n 36423+200n

## ■Synchronous parameters: Auxiliary shaft

n: Axis No. - 1

Item	Buffer memory address
[Pr.418] Auxiliary shaft axis No.	36430+200n
[Pr.419] Composite auxiliary shaft gear	36431+200n
[Pr.420] Auxiliary shaft gear: Numerator	36432+200n 36433+200n
[Pr.421] Auxiliary shaft gear: Denominator	36434+200n 36435+200n
[Pr.422] Auxiliary shaft clutch control setting	36436+200n
[Pr.423] Auxiliary shaft clutch reference address setting	36437+200n
[Pr.424] Auxiliary shaft clutch ON address	36438+200n 36439+200n
[Pr.425] Movement amount before auxiliary shaft clutch ON	36440+200n 36441+200n
[Pr.426] Auxiliary shaft clutch OFF address	36442+200n 36443+200n
[Pr.427] Movement amount before auxiliary shaft clutch OFF	36444+200n 36445+200n
[Pr.428] Auxiliary shaft clutch smoothing method	36446+200n
[Pr.429] Auxiliary shaft clutch smoothing time constant	36447+200n
[Pr.430] Slippage at auxiliary shaft clutch ON	36448+200n 36449+200n
[Pr.431] Slippage at auxiliary shaft clutch OFF	36450+200n 36451+200n

## ■Synchronous parameters: Speed change gear

n: Axis No. - 1

Item		Buffer memory address
[Pr.434]	Speed change gear	36460+200n
[Pr.435]	Speed change gear smoothing time constant	36461+200n
[Pr.436]	Speed change ratio: Numerator	36462+200n 36463+200n
[Pr.437]	Speed change ratio: Denominator	36464+200n 36465+200n

## ■Synchronous parameters: Output axis

n: Axis No. - 1

Item		Buffer memory address
[Pr.438]	Cam axis cycle unit setting	36470+200n
[Pr.439]	Cam axis length per cycle	36472+200n 36473+200n
[Pr.440]	Cam No.	36474+200n
[Pr.441]	Cam stroke amount	36476+200n 36477+200n
[Pr.444]	Cam axis phase compensation advance time	36482+200n 36483+200n
[Pr.445]	Cam axis phase compensation time constant	36484+200n
[Pr.446]	Synchronous control deceleration time	36485+200n
[Pr.447]	Output axis smoothing time constant	36486+200n

## ■Synchronous parameters: Synchronous control initial position

n: Axis No. - 1

Item		Buffer memory address
[Pr.460]	Setting method of current value per cycle after main shaft gear	36500+200n
[Pr.461]	Setting method of current value per cycle after auxiliary shaft gear	36501+200n
[Pr.462]	Cam axis position restoration object	36502+200n
[Pr.463]	Setting method of cam reference position	36503+200n
[Pr.464]	Setting method of cam axis current value per cycle	36504+200n
[Pr.465]	Current value per cycle after main shaft gear (Initial setting)	36506+200n 36507+200n
[Pr.466]	Current value per cycle after auxiliary shaft gear (Initial setting)	36508+200n 36509+200n
[Pr.467]	Cam reference position (Initial setting)	36510+200n 36511+200n
[Pr.468]	Cam axis current value per cycle (Initial setting)	36512+200n 36513+200n

A

## Monitor data

### ■ Servo input axis monitor data

n: Axis No. - 1

Item		Buffer memory address
[Md.300]	Servo input axis current value	33120+10n 33121+10n
[Md.301]	Servo input axis speed	33122+10n 33123+10n
[Md.302]	Servo input axis phase compensation amount	33124+10n 33125+10n
[Md.303]	Servo input axis rotation direction restriction amount	33126+10n 33127+10n

### ■ Synchronous encoder axis monitor data

j: Synchronous encoder axis No. - 1

Item		Buffer memory address
[Md.320]	Synchronous encoder axis current value	35200+20j 35201+20j
[Md.321]	Synchronous encoder axis current value per cycle	35202+20j 35203+20j
[Md.322]	Synchronous encoder axis speed	35204+20j 35205+20j
[Md.323]	Synchronous encoder axis phase compensation amount	35206+20j 35207+20j
[Md.324]	Synchronous encoder axis rotation direction restriction amount	35208+20j 35209+20j
[Md.325]	Synchronous encoder axis status	35210+20j
[Md.326]	Synchronous encoder axis error No.	35211+20j
[Md.327]	Synchronous encoder axis warning No.	35212+20j

### ■ Command generation axis monitor data

n: Axis No. - 1

Item		Buffer memory address
[Md.20]	Feed current value	60900+120n 60901+120n
[Md.22]	Feedrate	60904+120n 60905+120n
[Md.23]	Axis error No.	60906+120n
[Md.24]	Axis warning No.	60907+120n
[Md.25]	Valid M code	60908+120n
[Md.26]	Axis operation status	60909+120n
[Md.27]	Current speed	60910+120n 60911+120n
[Md.28]	Axis feedrate	60912+120n 60913+120n
[Md.29]	Speed-position switching control positioning movement amount	60914+120n 60915+120n
[Md.31]	Status	60917+120n
[Md.32]	Target value	60918+120n 60919+120n
[Md.33]	Target speed	60920+120n 60921+120n
[Md.38]	Start positioning data No. setting value	60929+120n
[Md.39]	In speed limit flag	60930+120n
[Md.40]	In speed change processing flag	60931+120n
[Md.42]	Control system repetition counter	60933+120n
[Md.44]	Positioning data No. being executed	60935+120n

Item		Buffer memory address	
[Md.46]	Last executed positioning data No.	60937+120n	
[Md.47]	Positioning data being executed	Positioning identifier	60938+120n
		M code	60939+120n
		Dwell time	60940+120n
		Command speed	60942+120n 60943+120n
		Positioning address	60944+120n 60945+120n
[Md.48]	Deceleration start flag	60999+120n	
[Md.122]	Speed during command	60992+120n 60993+120n	
[Md.141]	BUSY	61004+120n	
[Md.345]	Command generation axis accumulative current value	61000+120n	
		61001+120n	
[Md.347]	Command generation axis current value per cycle	61002+120n	
		61003+120n	

\*1 The buffer memory addresses for axes and command generation axes are different.

Refer to "List of Buffer Memory Addresses" in the following manual for the buffer memory addresses for servo amplifier axes.

📖 MELSEC iQ-F FX5 Motion Module/Simple Motion Module User's Manual (Application)

## ■ Synchronous control monitor data

n: Axis No. - 1

Item		Buffer memory address
[Md.400]	Current value after composite main shaft gear	42800+40n 42801+40n
[Md.401]	Current value per cycle after main shaft gear	42802+40n 42803+40n
[Md.402]	Current value per cycle after auxiliary shaft gear	42804+40n 42805+40n
[Md.406]	Cam axis phase compensation amount	42810+40n 42811+40n
[Md.407]	Cam axis current value per cycle	42812+40n 42813+40n
[Md.408]	Cam reference position	42814+40n 42815+40n
[Md.409]	Cam axis feed current value	42816+40n 42817+40n
[Md.410]	Execute cam No.	42818+40n
[Md.411]	Execute cam stroke amount	42820+40n 42821+40n
[Md.420]	Main shaft clutch ON/OFF status	42828+40n
[Md.421]	Main shaft clutch smoothing status	42829+40n
[Md.422]	Main shaft clutch slippage (accumulative)	42830+40n 42831+40n
[Md.423]	Auxiliary shaft clutch ON/OFF status	42832+40n
[Md.424]	Auxiliary shaft clutch smoothing status	42833+40n
[Md.425]	Auxiliary shaft clutch slippage (accumulative)	42834+40n 42835+40n

## ■ Cam operation monitor data: Cam position calculation

Item		Buffer memory address
[Md.600]	Cam position calculation result	53800 53801

A

## Control data

### ■Command generation axis control data

n: Axis No. - 1

Item	Buffer memory address	
[Cd.3]	Positioning start No.	61860+128n
[Cd.5]	Axis error reset	61862+128n
[Cd.6]	Restart command	61863+128n
[Cd.7]	M code OFF request	61864+128n
[Cd.9]	New current value	61866+128n 61867+128n
[Cd.10]	New acceleration time value	61868+128n 61869+128n
[Cd.11]	New deceleration time value	61870+128n 61871+128n
[Cd.12]	Acceleration/deceleration time change value during speed change, enable/disable	61872+128n
[Cd.13]	Positioning operation speed override	61873+128n
[Cd.14]	New speed value	61874+128n 61875+128n
[Cd.15]	Speed change request	61876+128n
[Cd.17]	JOG speed	61878+128n 61879+128n
[Cd.18]	Interrupt request during continuous operation	61880+128n
[Cd.23]	Speed-position switching control movement amount change register	61886+128n 61887+128n
[Cd.24]	Speed-position switching enable flag	61888+128n
[Cd.27]	Target position change value (New address)	61894+128n 61895+128n
[Cd.28]	Target position change value (New speed)	61896+128n 61897+128n
[Cd.29]	Target position change request flag	61898+128n
[Cd.40]	ABS direction in degrees	61910+128n
[Cd.46]	Speed-position switching command	61927+128n
[Cd.180]	Axis stop	61960+128n
[Cd.181]	Forward run JOG start	61961+128n
[Cd.182]	Reverse run JOG start	61962+128n
[Cd.184]	Positioning start	61964+128n
[Cd.300]	Command generation axis parameter No. designation	61970+128n
[Cd.301]	Command generation axis parameter setting value	61972+128n 61973+128n
[Cd.302]	Command generation axis parameter control request	61971+128n
[Cd.303]	Command generation axis positioning data No. designation	61974+128n
[Cd.304]	Command generation axis positioning data designation	61975+128n
[Cd.305]	Command generation axis positioning data setting value	61976+128n 61977+128n
[Cd.306]	Command generation axis positioning data control request	61978+128n

\*1 The buffer memory addresses for axes and command generation axes are different.

Refer to "List of Buffer Memory Addresses" in the following manual for the buffer memory addresses for servo amplifier axes.

 MELSEC iQ-F FX5 Motion Module/Simple Motion Module User's Manual (Application)

### ■Synchronous control system control data

Item	Buffer memory address	
[Cd.380]	Synchronous control start	36320
[Cd.381]	Synchronous control analysis mode	36322



## ■Synchronous encoder axis control data

j: Synchronous encoder axis No. - 1

Item		Buffer memory address
[Cd.320]	Synchronous encoder axis control start	35040+10j
[Cd.321]	Synchronous encoder axis control method	35041+10j
[Cd.322]	Synchronous encoder axis current value setting address	35042+10j 35043+10j
[Cd.323]	Synchronous encoder axis error reset	35044+10j
[Cd.324]	Connection command of synchronous encoder via CPU	35045+10j
[Cd.325]	Input value for synchronous encoder via CPU	35046+10j 35047+10j

## ■Control data for synchronous control

n: Axis No. - 1

Item		Buffer memory address
[Cd.400]	Main shaft clutch command	44080+20n
[Cd.401]	Main shaft clutch control invalid command	44081+20n
[Cd.402]	Main shaft clutch forced OFF command	44082+20n
[Cd.403]	Auxiliary shaft clutch command	44083+20n
[Cd.404]	Auxiliary shaft clutch control invalid command	44084+20n
[Cd.405]	Auxiliary shaft clutch forced OFF command	44085+20n
[Cd.406]	Synchronous control change request	44086+20n
[Cd.407]	Synchronous control change command	44087+20n
[Cd.408]	Synchronous control change value	44088+20n 44089+20n
[Cd.409]	Synchronous control reflection time	44090+20n

## ■Cam operation control data: Cam data operation

Item		Buffer memory address
[Cd.600]	Cam data operation request	45000
[Cd.601]	Operation cam No.	45001
[Cd.602]	Cam data first position	45002
[Cd.603]	Number of cam data operation points	45003
[Cd.604]	Cam data format	45004
[Cd.605]	Cam resolution/coordinate number	45005
[Cd.606]	Cam data starting point	45006
[Cd.607]	Cam data value	45008 to 53199

A

## ■Cam operation control data: Cam auto-generation

Item		Buffer memory address
[Cd.608]	Cam auto-generation request	53200
[Cd.609]	Cam auto-generation cam No.	53201
[Cd.610]	Cam auto-generation type	53202
[Cd.611]	Cam auto-generation data <sup>*1</sup>	53204 to 53779

\*1 The item details on the cam auto-generation are shown below.

- Cam auto-generation data for rotary cutter

Details	Buffer memory address
Cam resolution	53204
Sheet length	53206 53207
Sheet synchronous width	53208 53209
Synchronous axis length	53210 53211
Synchronization starting point	53212 53213
Synchronous section acceleration ratio	53214

## ■Cam operation control data: Cam position calculation

Item		Buffer memory address
[Cd.612]	Cam position calculation request	53780
[Cd.613]	Cam position calculation: Cam No.	53781
[Cd.614]	Cam position calculation: Stroke amount	53782 53783
[Cd.615]	Cam position calculation: Cam axis length per cycle	53784 53785
[Cd.616]	Cam position calculation: Cam reference position	53786 53787
[Cd.617]	Cam position calculation: Cam axis current value per cycle	53788 53789
[Cd.618]	Cam position calculation: Cam axis feed current value	53790 53791

# Appendix 2 Sample Program of Synchronous Control

## Program example [FX5-SSC-S]

The following shows a sample program of executing synchronous control on the axis 1 with the axis 4 as an input axis using the 4-axis module. (The axis 4 is configured as the virtual servo amplifier.)

1. Set MR-J4(W)-B on the axis 1 and the virtual servo amplifier on the axis 4 in the "System Configuration" window.

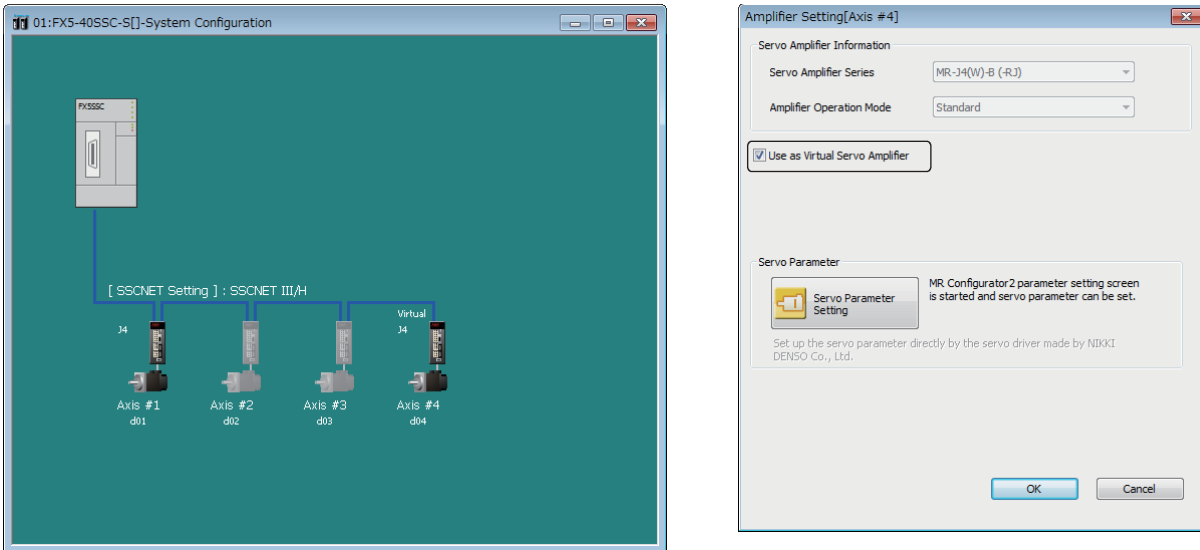

2. Set the axis 4 as the servo input axis in the "Input Axis Parameter" window.

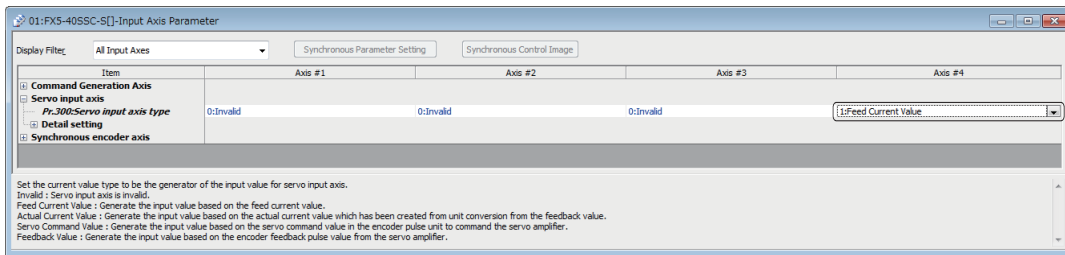

3. Create the cam data (cam No.1).

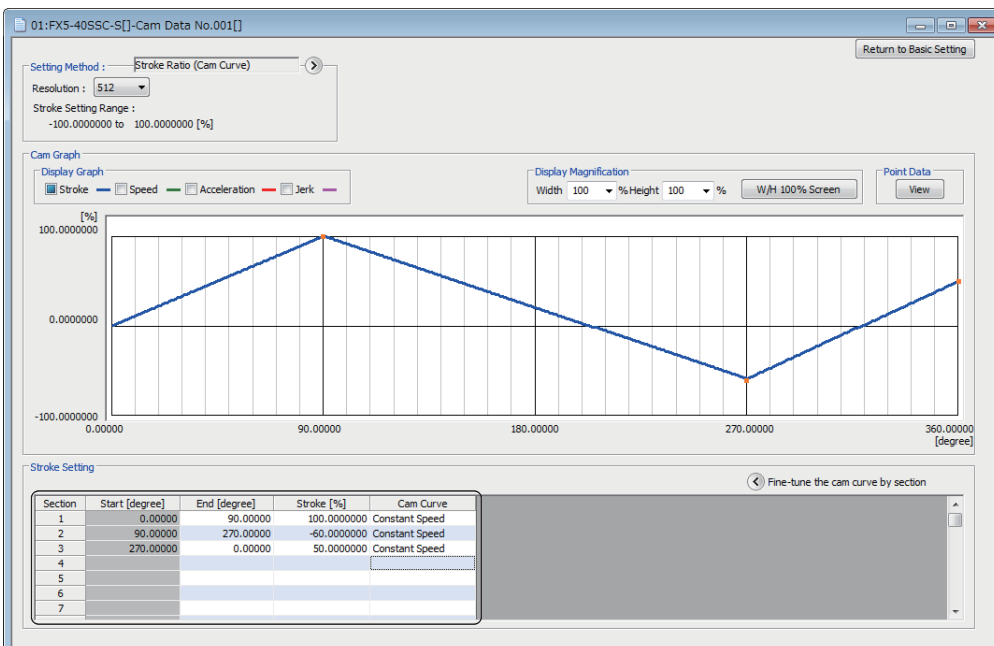

4. Set the synchronous parameter of the axis 1.

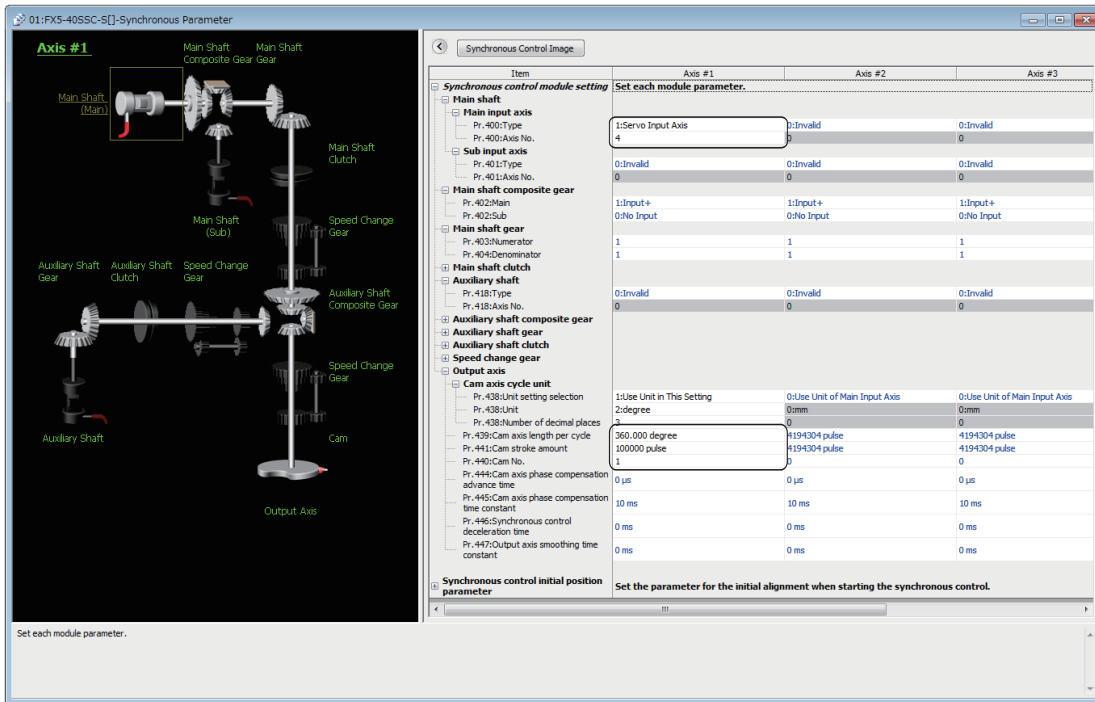

5. Create the program to start synchronous control.

The sample program when head I/O No. of the Simple Motion module is set to 01H is shown below.

- For using labels

Classification	Label name	Description																																																												
Module label	FX5SSC_1.stSysMntr2_D.bSynchronizationFlag_D	Synchronization flag																																																												
	FX5SSC_1.stSysCtrl_D.bPLC_Ready_D	PLC READY																																																												
	FX5SSC_1.stSysCtrl_D.bAllAxisServoOn_D	All axis servo ON																																																												
	FX5SSC_1.stSysMntr2_D.bnBusy_D[0]	Axis 1 BUSY																																																												
	FX5SSC_1.stnAxMntr_D[0].wAxisOperationStatus_D	Axis 1 Axis operation status																																																												
	FX5SSC_1.stSysMntr2_D.bnBusy_D[3]	Axis 4 BUSY																																																												
Global label, Local label	Defines the global label or the local label as follows. The settings of Assign (Device/Label) are not required for the label that the assignment device is not set because the unused internal relay and data device are automatically assigned. The following is for global labels.																																																													
	<table border="1"> <thead> <tr> <th></th> <th>Label Name</th> <th>Data Type</th> <th>Class</th> </tr> </thead> <tbody> <tr><td>1</td><td>G_bStartSync</td><td>Bit</td><td>VAR_GLOBAL</td></tr> <tr><td>2</td><td>G_bSyncReq</td><td>Bit</td><td>VAR_GLOBAL</td></tr> <tr><td>3</td><td>G_udJOGSpeed</td><td>Double Word [Unsigned]/Bit String [32-bit]</td><td>VAR_GLOBAL</td></tr> <tr><td>4</td><td>G_bJogReq</td><td>Bit</td><td>VAR_GLOBAL</td></tr> <tr><td>5</td><td>G_bSyncENO</td><td>Bit</td><td>VAR_GLOBAL</td></tr> <tr><td>6</td><td>G_bSyncOK</td><td>Bit</td><td>VAR_GLOBAL</td></tr> <tr><td>7</td><td>G_bSyncErr</td><td>Bit</td><td>VAR_GLOBAL</td></tr> <tr><td>8</td><td>G_uSyncErrID</td><td>Word [Unsigned]/Bit String [16-bit]</td><td>VAR_GLOBAL</td></tr> <tr><td>9</td><td>G_bJogENO</td><td>Bit</td><td>VAR_GLOBAL</td></tr> <tr><td>10</td><td>G_bJogOK</td><td>Bit</td><td>VAR_GLOBAL</td></tr> <tr><td>11</td><td>G_bInputForwardJogStartReq</td><td>Bit</td><td>VAR_GLOBAL</td></tr> <tr><td>12</td><td>G_bInputReverseJogStartReq</td><td>Bit</td><td>VAR_GLOBAL</td></tr> <tr><td>13</td><td>G_bJogErr</td><td>Bit</td><td>VAR_GLOBAL</td></tr> <tr><td>14</td><td>G_uJogErrID</td><td>Word [Unsigned]/Bit String [16-bit]</td><td>VAR_GLOBAL</td></tr> </tbody> </table>		Label Name	Data Type	Class	1	G_bStartSync	Bit	VAR_GLOBAL	2	G_bSyncReq	Bit	VAR_GLOBAL	3	G_udJOGSpeed	Double Word [Unsigned]/Bit String [32-bit]	VAR_GLOBAL	4	G_bJogReq	Bit	VAR_GLOBAL	5	G_bSyncENO	Bit	VAR_GLOBAL	6	G_bSyncOK	Bit	VAR_GLOBAL	7	G_bSyncErr	Bit	VAR_GLOBAL	8	G_uSyncErrID	Word [Unsigned]/Bit String [16-bit]	VAR_GLOBAL	9	G_bJogENO	Bit	VAR_GLOBAL	10	G_bJogOK	Bit	VAR_GLOBAL	11	G_bInputForwardJogStartReq	Bit	VAR_GLOBAL	12	G_bInputReverseJogStartReq	Bit	VAR_GLOBAL	13	G_bJogErr	Bit	VAR_GLOBAL	14	G_uJogErrID	Word [Unsigned]/Bit String [16-bit]	VAR_GLOBAL	
	Label Name	Data Type	Class																																																											
1	G_bStartSync	Bit	VAR_GLOBAL																																																											
2	G_bSyncReq	Bit	VAR_GLOBAL																																																											
3	G_udJOGSpeed	Double Word [Unsigned]/Bit String [32-bit]	VAR_GLOBAL																																																											
4	G_bJogReq	Bit	VAR_GLOBAL																																																											
5	G_bSyncENO	Bit	VAR_GLOBAL																																																											
6	G_bSyncOK	Bit	VAR_GLOBAL																																																											
7	G_bSyncErr	Bit	VAR_GLOBAL																																																											
8	G_uSyncErrID	Word [Unsigned]/Bit String [16-bit]	VAR_GLOBAL																																																											
9	G_bJogENO	Bit	VAR_GLOBAL																																																											
10	G_bJogOK	Bit	VAR_GLOBAL																																																											
11	G_bInputForwardJogStartReq	Bit	VAR_GLOBAL																																																											
12	G_bInputReverseJogStartReq	Bit	VAR_GLOBAL																																																											
13	G_bJogErr	Bit	VAR_GLOBAL																																																											
14	G_uJogErrID	Word [Unsigned]/Bit String [16-bit]	VAR_GLOBAL																																																											

# Program example

For details of the module FBs, refer to "Simple Motion Module FB/Motion Module FB" in the following manual.

📖 MELSEC iQ-F FX5 Motion Module/Simple Motion Module FB Reference

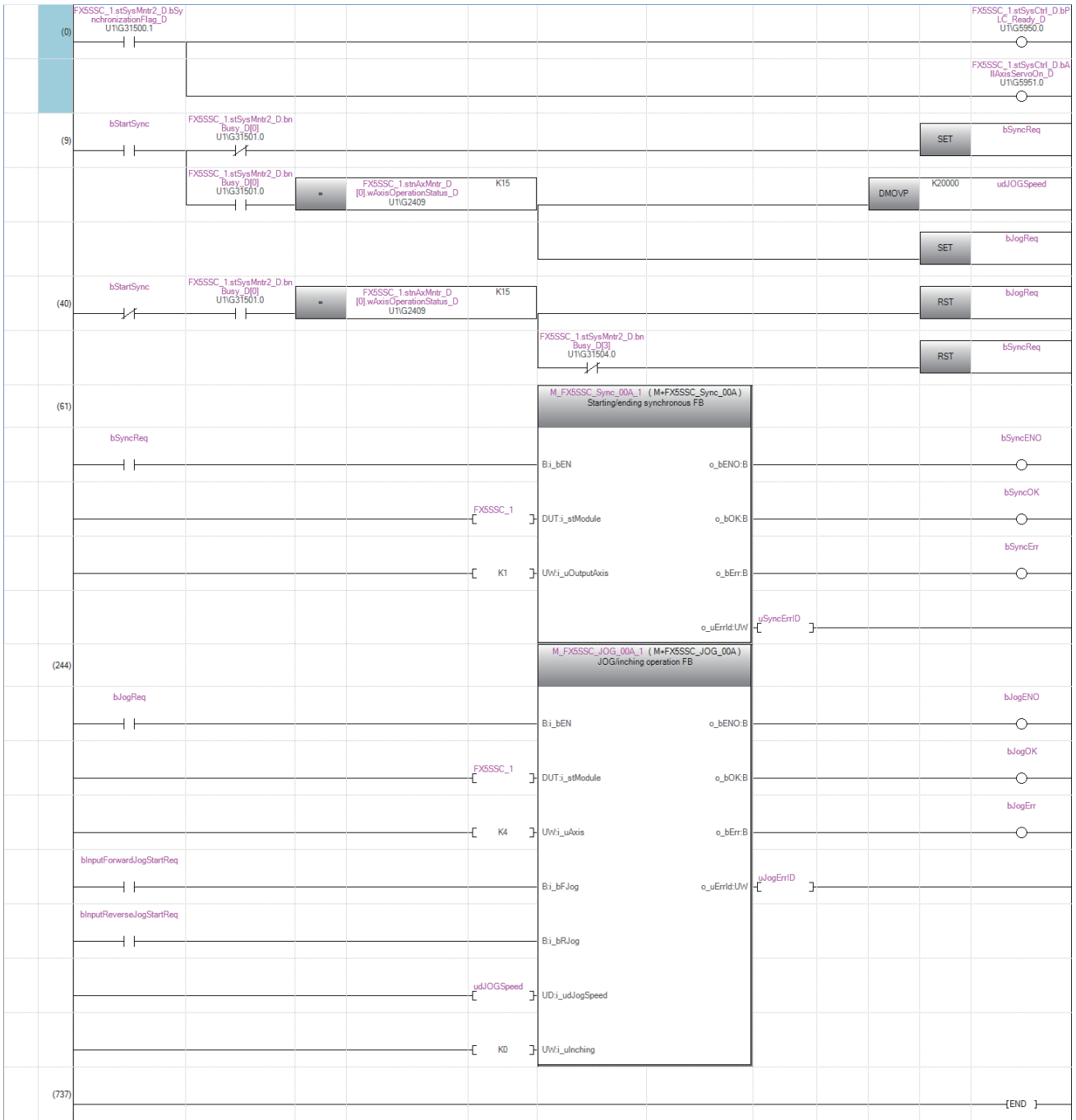

- For using buffer memory

## Program example

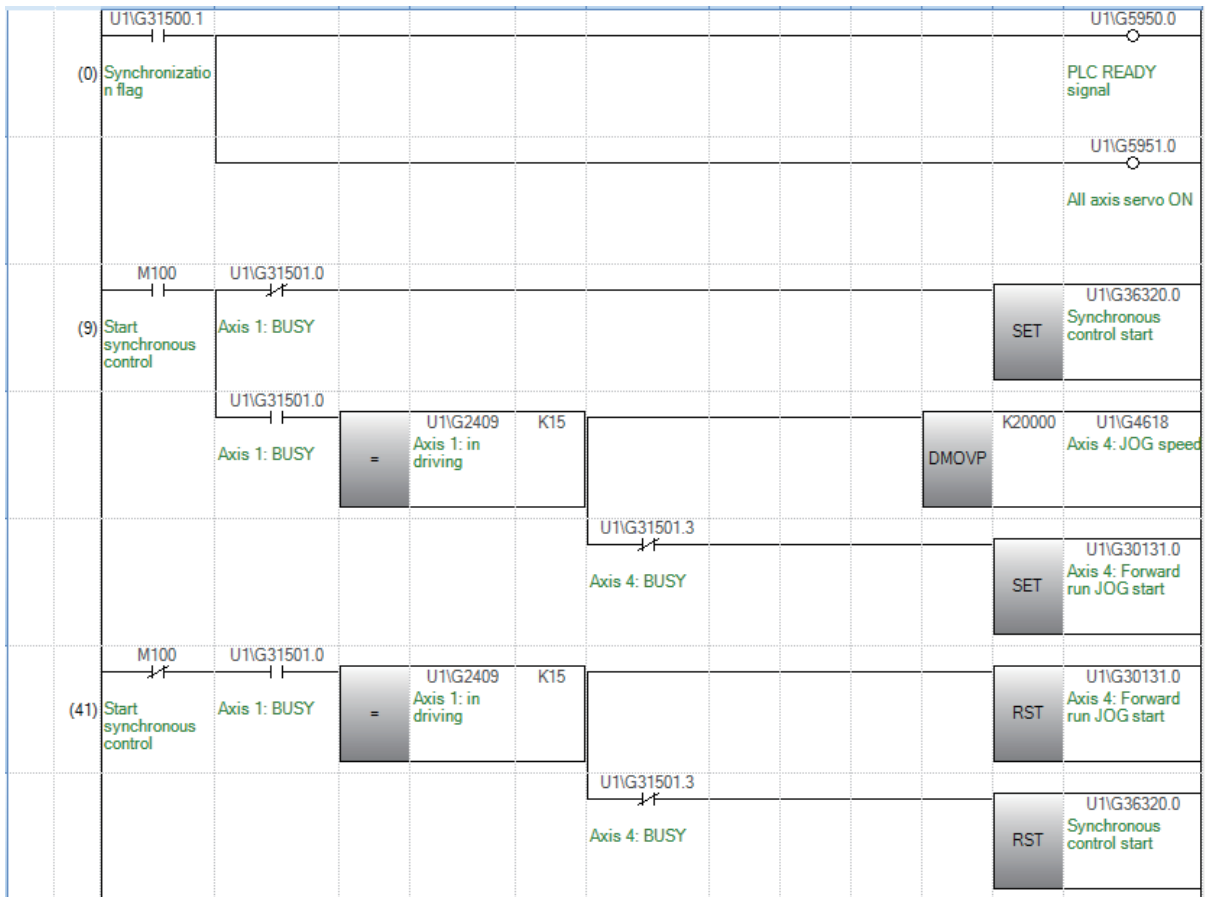

# Program example [FX5-SSC-G]

The following shows a sample program of executing synchronous control on the axis 1 with the axis 4 as an input axis using the 4-axis module. (The axis 4 is configured as the virtual servo amplifier.)

1. On the "CC-Link IE TSN" screen, set MR-J5-G for station No. 1 and 2, then set station No.1 and station No.2 as axis 1 and axis 4, respectively, on the "Parameter" screen.

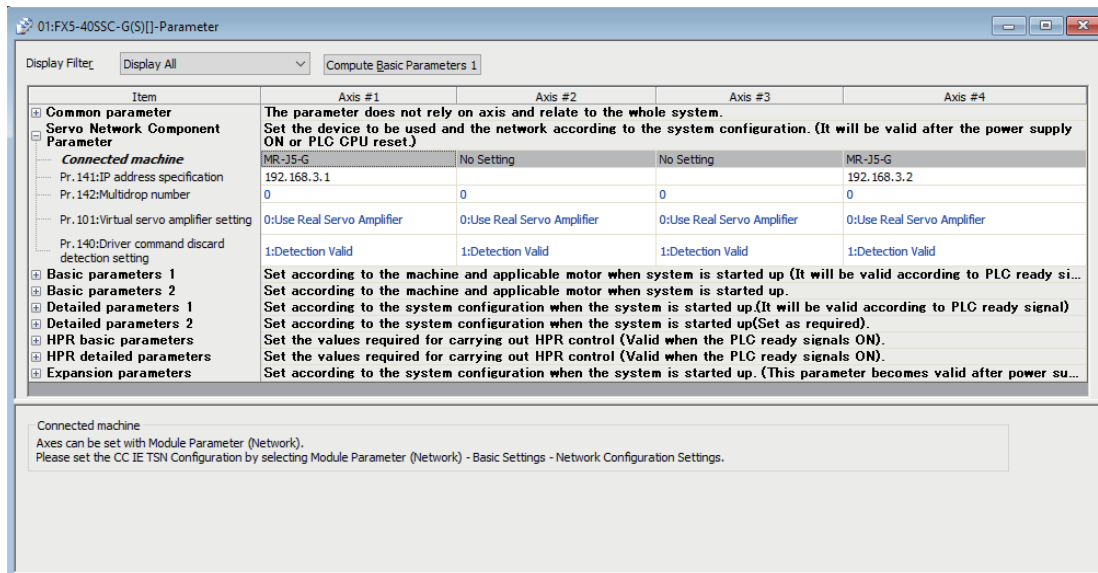
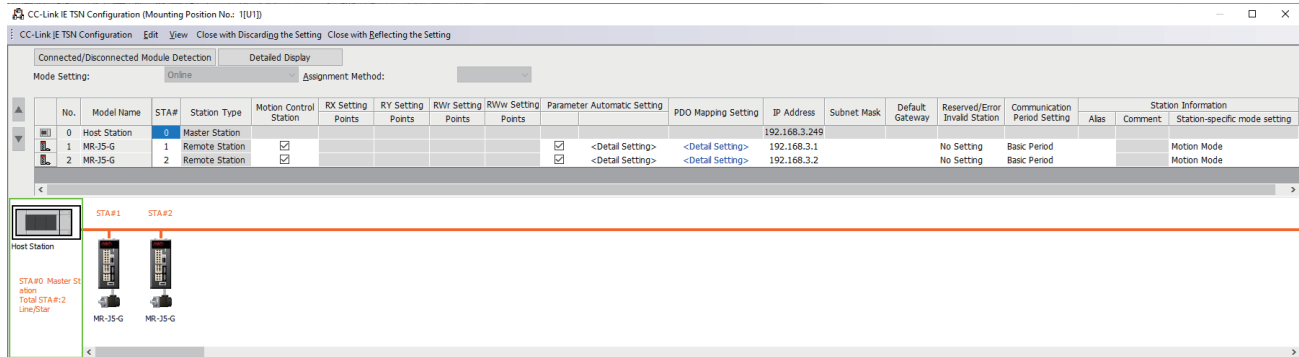

2. Set the axis 4 as the servo input axis in the "Input Axis Parameter" window.

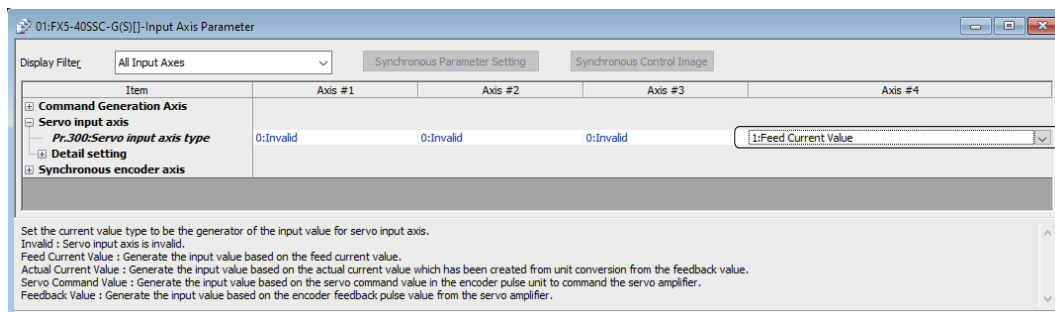

### 3. Create the cam data (cam No.1).

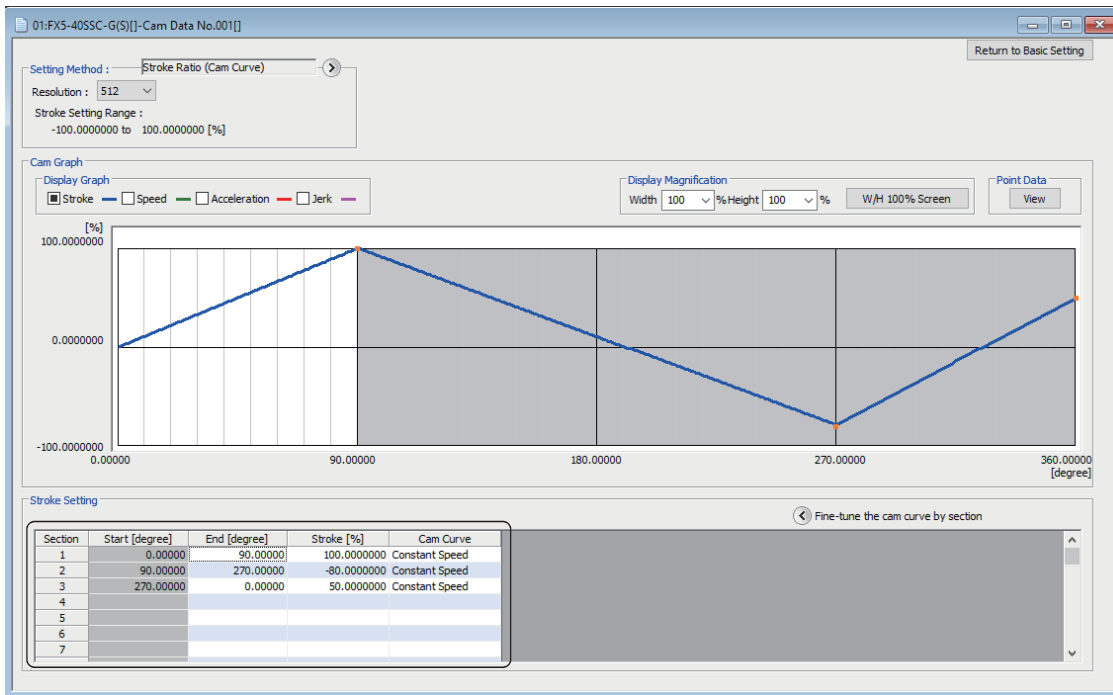

### 4. Set the synchronous parameter of the axis 1.

Synchronous Control Image

Item	Axis #1	Axis #2	Axis #3
<b>Synchronous control module setting</b>			
Set each module parameter.			
<b>Main shaft</b>			
Main input axis	1: Servo Input Axis	0: Invalid	0: Invalid
Pr-400:Type	4	0	0
Pr-400:Axis No.	1	0	0
Sub input axis	0: Invalid	0: Invalid	0: Invalid
Pr-401:Type	0	0	0
Pr-401:Axis No.	0	0	0
Main shaft composite gear	1: Input+	1: Input+	1: Input+
Pr-402:Main	0: No Input	0: No Input	0: No Input
Pr-402:Sub			
Main shaft gear	1	1	1
Pr-403:Numerator	1	1	1
Pr-404:Denominator			
Main shaft clutch	0: Invalid	0: Invalid	0: Invalid
Pr-418:Type	0	0	0
Pr-418:Axis No.	0	0	0
Auxiliary shaft composite gear			
Auxiliary shaft gear			
Auxiliary shaft clutch			
Speed change gear			
Output axis			
Cam axis cycle unit	1: Use Unit in This Setting	0: Use Unit of Main Input Axis	0: Use Unit of Main Input Axis
Pr-438:Unit	2: degree	0: mm	0: mm
Pr-439:Number of decimal places	3	0	0
Pr-441:Cam axis length per cycle	360.000 degree	4194304 pulse	4194304 pulse
Pr-441:Cam stroke amount	4194304 pulse	4194304 pulse	4194304 pulse
Pr-440:Cam No.	0	0	0
Pr-446:Cam axis phase compensation advance time	0 μs	0 μs	0 μs
Pr-445:Cam axis phase compensation time constant	10 ms	10 ms	10 ms
Pr-446:Synchronous control deceleration time	0 ms	0 ms	0 ms
Pr-447:Output axis smoothing time constant	0 ms	0 ms	0 ms
<b>Synchronous control initial position parameter</b>			
Set the parameter for the initial alignment when starting the synchronous control.			



**5.** Create the program to start synchronous control.

The sample program when headstart I/O No. of the Simple Motion module is set to 01H is shown below.

- For using labels

Classification	Label name	Description																																																												
Module label	FX5SSC_1.stSysMntr2_D.bSynchronizationFlag_D	Synchronization flag																																																												
	FX5SSC_1.stSysCtrl_D.bPLC_Ready_D	PLC READY																																																												
	FX5SSC_1.stSysCtrl_D.bAllAxisServoOn_D	All axis servo ON																																																												
	FX5SSC_1.stSysMntr2_D.bnBusy_D[0]	Axis 1 BUSY																																																												
	FX5SSC_1.stnAxMntr_D[0].wAxisOperationStatus_D	Axis 1 Axis operation status																																																												
	FX5SSC_1.stSysMntr2_D.bnBusy_D[3]	Axis 4 BUSY																																																												
Global label, Local label	Defines the global label or the local label as follows. The settings of Assign (Device/Label) are not required for the label that the assignment device is not set because the unused internal relay and data device are automatically assigned. The following is for global labels.																																																													
	<table border="1"> <thead> <tr> <th></th> <th>Label Name</th> <th>Data Type</th> <th>Class</th> </tr> </thead> <tbody> <tr> <td>1</td> <td>G_bStartSync</td> <td>Bit</td> <td>VAR_GLOBAL</td> </tr> <tr> <td>2</td> <td>G_bSyncReq</td> <td>Bit</td> <td>VAR_GLOBAL</td> </tr> <tr> <td>3</td> <td>G_udJOGSpeed</td> <td>Double Word [Unsigned]/Bit String [32-bit]</td> <td>VAR_GLOBAL</td> </tr> <tr> <td>4</td> <td>G_bJogReq</td> <td>Bit</td> <td>VAR_GLOBAL</td> </tr> <tr> <td>5</td> <td>G_bSyncENO</td> <td>Bit</td> <td>VAR_GLOBAL</td> </tr> <tr> <td>6</td> <td>G_bSyncOK</td> <td>Bit</td> <td>VAR_GLOBAL</td> </tr> <tr> <td>7</td> <td>G_bSyncErr</td> <td>Bit</td> <td>VAR_GLOBAL</td> </tr> <tr> <td>8</td> <td>G_uSyncErrID</td> <td>Word [Unsigned]/Bit String [16-bit]</td> <td>VAR_GLOBAL</td> </tr> <tr> <td>9</td> <td>G_bJogENO</td> <td>Bit</td> <td>VAR_GLOBAL</td> </tr> <tr> <td>10</td> <td>G_bJogOK</td> <td>Bit</td> <td>VAR_GLOBAL</td> </tr> <tr> <td>11</td> <td>G_bInputForwardJogStartReq</td> <td>Bit</td> <td>VAR_GLOBAL</td> </tr> <tr> <td>12</td> <td>G_bInputReverseJogStartReq</td> <td>Bit</td> <td>VAR_GLOBAL</td> </tr> <tr> <td>13</td> <td>G_bJogErr</td> <td>Bit</td> <td>VAR_GLOBAL</td> </tr> <tr> <td>14</td> <td>G_uJogErrID</td> <td>Word [Unsigned]/Bit String [16-bit]</td> <td>VAR_GLOBAL</td> </tr> </tbody> </table>		Label Name	Data Type	Class	1	G_bStartSync	Bit	VAR_GLOBAL	2	G_bSyncReq	Bit	VAR_GLOBAL	3	G_udJOGSpeed	Double Word [Unsigned]/Bit String [32-bit]	VAR_GLOBAL	4	G_bJogReq	Bit	VAR_GLOBAL	5	G_bSyncENO	Bit	VAR_GLOBAL	6	G_bSyncOK	Bit	VAR_GLOBAL	7	G_bSyncErr	Bit	VAR_GLOBAL	8	G_uSyncErrID	Word [Unsigned]/Bit String [16-bit]	VAR_GLOBAL	9	G_bJogENO	Bit	VAR_GLOBAL	10	G_bJogOK	Bit	VAR_GLOBAL	11	G_bInputForwardJogStartReq	Bit	VAR_GLOBAL	12	G_bInputReverseJogStartReq	Bit	VAR_GLOBAL	13	G_bJogErr	Bit	VAR_GLOBAL	14	G_uJogErrID	Word [Unsigned]/Bit String [16-bit]	VAR_GLOBAL	
	Label Name	Data Type	Class																																																											
1	G_bStartSync	Bit	VAR_GLOBAL																																																											
2	G_bSyncReq	Bit	VAR_GLOBAL																																																											
3	G_udJOGSpeed	Double Word [Unsigned]/Bit String [32-bit]	VAR_GLOBAL																																																											
4	G_bJogReq	Bit	VAR_GLOBAL																																																											
5	G_bSyncENO	Bit	VAR_GLOBAL																																																											
6	G_bSyncOK	Bit	VAR_GLOBAL																																																											
7	G_bSyncErr	Bit	VAR_GLOBAL																																																											
8	G_uSyncErrID	Word [Unsigned]/Bit String [16-bit]	VAR_GLOBAL																																																											
9	G_bJogENO	Bit	VAR_GLOBAL																																																											
10	G_bJogOK	Bit	VAR_GLOBAL																																																											
11	G_bInputForwardJogStartReq	Bit	VAR_GLOBAL																																																											
12	G_bInputReverseJogStartReq	Bit	VAR_GLOBAL																																																											
13	G_bJogErr	Bit	VAR_GLOBAL																																																											
14	G_uJogErrID	Word [Unsigned]/Bit String [16-bit]	VAR_GLOBAL																																																											





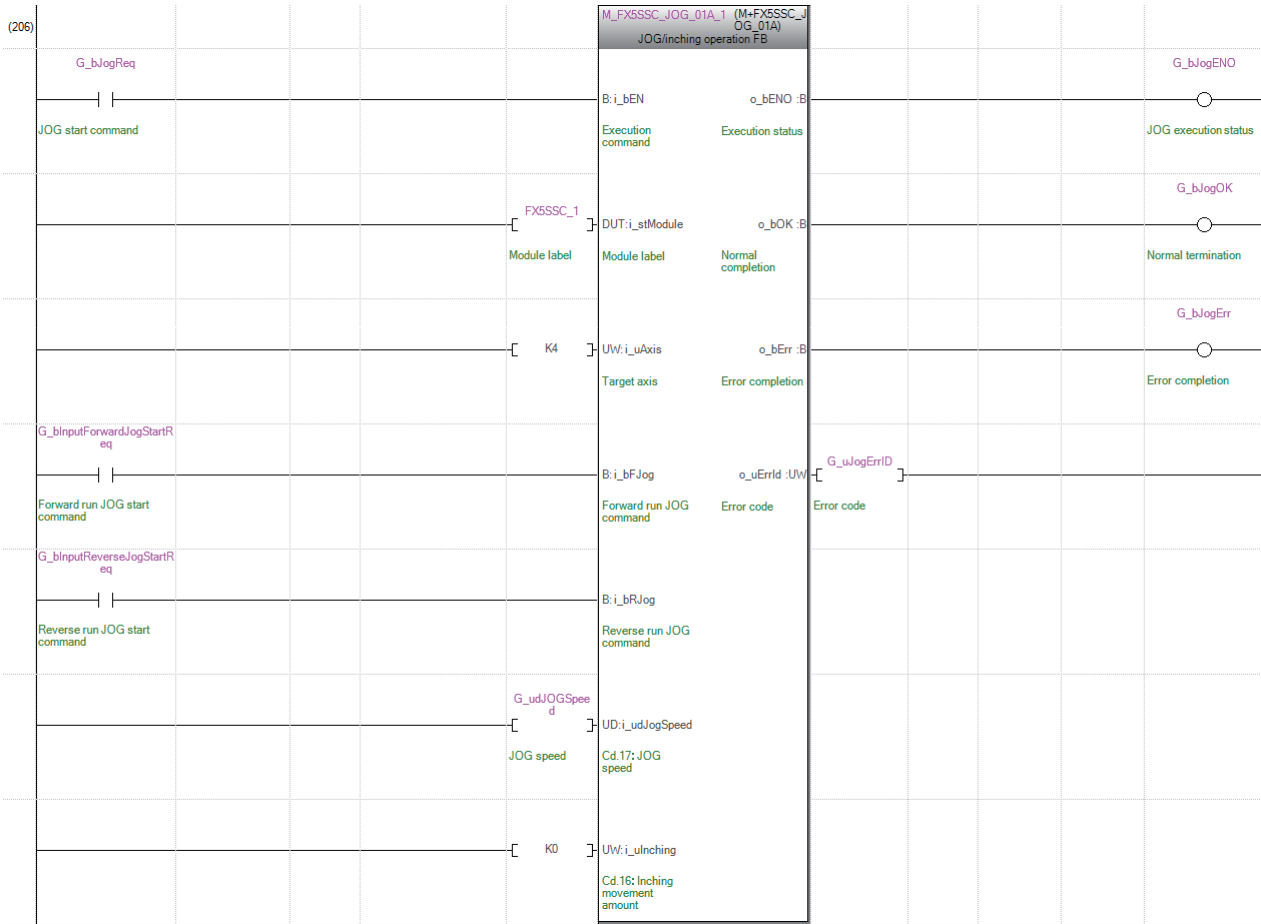

# INDEX

---

## A

---

- Auxiliary shaft axis No. . . . . 106
- Auxiliary shaft clutch command . . . . . 112
- Auxiliary shaft clutch control invalid command . . 112
- Auxiliary shaft clutch control setting . . . . . 107,108
- Auxiliary shaft clutch forced OFF command . . . . 112
- Auxiliary shaft clutch OFF address . . . . . 107,110
- Auxiliary shaft clutch ON address . . . . . 107,109
- Auxiliary shaft clutch ON/OFF status . . . . . 136,138
- Auxiliary shaft clutch reference address setting 107,109
- Auxiliary shaft clutch slippage (accumulative) 136,138
- Auxiliary shaft clutch smoothing method . . . 107,110
- Auxiliary shaft clutch smoothing status . . . . 136,138
- Auxiliary shaft clutch smoothing time constant 107,110
- Auxiliary shaft gear
  - Denominator . . . . . 105,106
  - Numerator . . . . . 105,106

## C

---

- Cam auto-generation cam No. . . . . 94
- Cam auto-generation data . . . . . 93,95
- Cam auto-generation request . . . . . 94
- Cam auto-generation type . . . . . 94
- Cam axis current value per cycle . . . . . 135,137
- Cam axis current value per cycle (Initial setting) . . . . 146,148
- Cam axis cycle unit setting . . . . . 128
- Cam axis feed current value . . . . . 135,137
- Cam axis length per cycle . . . . . 128
- Cam axis phase compensation advance time 128,129
- Cam axis phase compensation amount . . . . 135,137
- Cam axis phase compensation time constant 128,129
- Cam axis position restoration object . . . . . 146,147
- Cam data first position . . . . . 90,91
- Cam data format . . . . . 90,91
- Cam data operation request . . . . . 90,91
- Cam data starting point . . . . . 90,92
- Cam data value . . . . . 90,92
- Cam No. . . . . 128,129
- Cam position calculation
  - Cam axis current value per cycle . . . . . 161,162
  - Cam axis feed current value . . . . . 161,162
  - Cam axis length per cycle . . . . . 161,162
  - Cam No. . . . . 161,162
  - Cam reference position . . . . . 161,162
  - Stroke amount . . . . . 161,162
- Cam position calculation request . . . . . 161,162
- Cam position calculation result . . . . . 163
- Cam reference position . . . . . 135,137
- Cam reference position (Initial setting) . . . . 146,148
- Cam resolution/coordinate number . . . . . 90,92
- Cam stroke amount . . . . . 128,129
- Command generation axis accumulative current value 46
- Command generation axis current value per cycle 46
- Command generation axis length per cycle . . . . . 38
- Command generation axis parameter . . . . . 42
- Command generation axis parameter control request 42
- Command generation axis parameter No. designation 42

- Command generation axis parameter setting value 42
- Command generation axis positioning data . . . . . 42
- Command generation axis positioning data control request . . . . . 42
- Command generation axis positioning data designation 42
- Command generation axis positioning data No. designation . . . . . 42
- Command generation axis positioning data setting value 42
- Command generation axis valid setting . . . . . 38
- Composite auxiliary shaft gear . . . . . 105,106
- Composite main shaft gear . . . . . 97
- Connection command of synchronous encoder via CPU 74,76
- Current value after composite main shaft gear 135,136
- Current value per cycle after auxiliary shaft gear . . . . 135,137
- Current value per cycle after auxiliary shaft gear (Initial setting) . . . . . 146,147
- Current value per cycle after main shaft gear 135,137
- Current value per cycle after main shaft gear (Initial setting) . . . . . 146,147

## E

---

- Execute cam No. . . . . 136,137
- Execute cam stroke amount . . . . . 136,137

## I

---

- Input value for synchronous encoder via CPU . 74,76

## M

---

- Main input axis No. . . . . 96,97
- Main shaft clutch command . . . . . 104
- Main shaft clutch control invalid command . . . . . 104
- Main shaft clutch control setting . . . . . 99,100
- Main shaft clutch forced OFF command . . . . . 104
- Main shaft clutch OFF address . . . . . 99,102
- Main shaft clutch ON address . . . . . 99,101
- Main shaft clutch ON/OFF status . . . . . 136,138
- Main shaft clutch reference address setting . . 99,101
- Main shaft clutch slippage (accumulative) . . 136,138
- Main shaft clutch smoothing method . . . . . 99,102
- Main shaft clutch smoothing status . . . . . 136,138
- Main shaft clutch smoothing time constant . . 99,102
- Main shaft gear
  - Denominator . . . . . 98
  - Numerator . . . . . 98
- Movement amount before auxiliary shaft clutch OFF . 107,110
- Movement amount before auxiliary shaft clutch ON . . 107,109
- Movement amount before main shaft clutch OFF 99,102
- Movement amount before main shaft clutch ON 99,101

## N

---

- Number of cam data operation points . . . . . 90,91

## O

Operation cam No. . . . .	90,91
Output axis smoothing time constant. . . . .	128,130

## R

Resolution of synchronous encoder via CPU . . .	69,73
---	-------

## S

Servo input axis current value . . . . .	32
Servo input axis phase compensation advance time . . . . .	29,30
Servo input axis phase compensation amount . . . . .	32
Servo input axis phase compensation time constant . . . . .	29,30
Servo input axis rotation direction restriction . . . . .	29,31
Servo input axis rotation direction restriction amount . . . . .	33
Servo input axis smoothing time constant . . . . .	29,30
Servo input axis speed . . . . .	32
Servo input axis type . . . . .	29
Setting method of cam axis current value per cycle . . . . .	146,147
Setting method of cam reference position . . . . .	146,147
Setting method of current value per cycle after auxiliary shaft gear . . . . .	146,147
Setting method of current value per cycle after main shaft gear . . . . .	146
Slippage amount at auxiliary shaft clutch OFF . . . . .	108,111
Slippage amount at auxiliary shaft clutch ON . . . . .	108,111
Slippage amount at main shaft clutch OFF . . . . .	100,103
Slippage amount at main shaft clutch ON . . . . .	100,103
Speed change gear . . . . .	125
Speed change gear smoothing time constant . . . . .	125
Speed change ratio . . . . .	
Denominator . . . . .	125
Numerator . . . . .	125
Sub input axis No. . . . .	96,97
Synchronous control change command . . . . .	131,132
Synchronous control change request . . . . .	131
Synchronous control change value . . . . .	131,133
Synchronous control deceleration time . . . . .	128,130
Synchronous control reflection time . . . . .	131,134
Synchronous encoder axis control method . . . . .	74,75
Synchronous encoder axis control start . . . . .	74,75
Synchronous encoder axis current value . . . . .	77
Synchronous encoder axis current value per cycle . . . . .	77
Synchronous encoder axis current value setting address . . . . .	74,76
Synchronous encoder axis error No. . . . .	77,79
Synchronous encoder axis error reset . . . . .	74,76
Synchronous encoder axis length per cycle . . . . .	68,70
Synchronous encoder axis phase compensation advance time . . . . .	68,72
Synchronous encoder axis phase compensation amount . . . . .	77,78
Synchronous encoder axis phase compensation time constant . . . . .	68,72
Synchronous encoder axis rotation direction restriction . . . . .	68,73
Synchronous encoder axis rotation direction restriction amount . . . . .	77,78
Synchronous encoder axis smoothing time constant . . . . .	68,71
Synchronous encoder axis speed . . . . .	78
Synchronous encoder axis status . . . . .	77,78

Synchronous encoder axis type . . . . .	68,70
Synchronous encoder axis unit conversion . . . . .	
Denominator . . . . .	68,70
Numerator . . . . .	68,70
Synchronous encoder axis unit setting . . . . .	68,70
Synchronous encoder axis warning No. . . . .	77,79

# REVISIONS

\*The manual number is given on the bottom left of the back cover.

Revision date	*Manual number	Description
November 2014	IB(NA)-0300255-A	First edition
January 2015	IB(NA)-0300255-B	■Added or modified parts SAFETY PRECAUTIONS, RELEVANT MANUALS, TERMS, Section 1.1, 1.3, 2.1, 2.2, 4.9
August 2015	IB(NA)-0300255-C	■Added functions Command generation axis ■Added or modified parts Section 1.1, 1.2, 2.1, 2.2, 2.3, 3.1, 4.1, 4.2, 4.7, 4.9, 5.1, Appendix 1, 2
April 2016	IB(NA)-0300255-D	■Added or modified parts Appendix 1
October 2016	IB(NA)-0300255-E	■Added models FX5-80SSC-S ■Added or modified parts SAFETY PRECAUTIONS, INTRODUCTION, RELEVANT MANUALS, TERMS, Section 1.1, 1.2, 1.3, Chapter 2, Section 2.1, 2.2, 2.3, 3.1, 3.2, 4.1, 4.2, 4.3, 4.5, 4.8, 4.9, 5.3, 5.4, Appendix 1, 2
March 2021	IB(NA)-0300255ENG-F	■Added models FX5-40SSC-G, FX5-80SSC-G ■Added or modified parts SAFETY PRECAUTIONS, INTRODUCTION, RELEVANT MANUALS, TERMS, Chapter 1, Section 1.1, 1.2, 1.3, Chapter 2, Section 2.1, 2.2, 2.3, 3.1, 3.2, Chapter 4, Section 4.6, 4.7, 4.8, 4.9, Chapter 5, Section 5.1, 5.3, 5.4, 5.6, Appendix 1, 2, WARRANTY, TRADEMARKS

Japanese manual number: IB-0300254-E

This manual confers no industrial property rights of any other kind, nor does it confer any patent licenses. Mitsubishi Electric Corporation cannot be held responsible for any problems involving industrial property rights which may occur as a result of using the contents noted in this manual.

©2014 MITSUBISHI ELECTRIC CORPORATION

# WARRANTY

Please confirm the following product warranty details before using this product.

## 1. Gratis Warranty Term and Gratis Warranty Range

If any faults or defects (hereinafter "Failure") found to be the responsibility of Mitsubishi occurs during use of the product within the gratis warranty term, the product shall be repaired at no cost via the sales representative or Mitsubishi Service Company. However, if repairs are required onsite at domestic or overseas location, expenses to send an engineer will be solely at the customer's discretion. Mitsubishi shall not be held responsible for any re-commissioning, maintenance, or testing on-site that involves replacement of the failed module.

### [Gratis Warranty Term]

For terms of warranty, please contact your original place of purchase.

### [Gratis Warranty Range]

- (1) The range shall be limited to normal use within the usage state, usage methods and usage environment, etc., which follow the conditions and precautions, etc., given in the instruction manual, user's manual and caution labels on the product.
- (2) Even within the gratis warranty term, repairs shall be charged for in the following cases.
  1. Failure occurring from inappropriate storage or handling, carelessness or negligence by the user. Failure caused by the user's hardware or software design.
  2. Failure caused by unapproved modifications, etc., to the product by the user.
  3. When the Mitsubishi product is assembled into a user's device, Failure that could have been avoided if functions or structures, judged as necessary in the legal safety measures the user's device is subject to or as necessary by industry standards, had been provided.
  4. Failure that could have been avoided if consumable parts (battery, backlight, fuse, etc.) designated in the instruction manual had been correctly serviced or replaced.
  5. Relay failure or output contact failure caused by usage beyond the specified life of contact (cycles).
  6. Failure caused by external irresistible forces such as fires or abnormal voltages, and failure caused by force majeure such as earthquakes, lightning, wind and water damage.
  7. Failure caused by reasons unpredictable by scientific technology standards at time of shipment from Mitsubishi.
  8. Any other failure found not to be the responsibility of Mitsubishi or that admitted not to be so by the user.

## 2. Onerous repair term after discontinuation of production

- (1) Mitsubishi shall accept onerous product repairs for seven (7) years after production of the product is discontinued.  
Discontinuation of production shall be notified with Mitsubishi Technical Bulletins, etc.
- (2) Product supply (including repair parts) is not available after production is discontinued.

## 3. Overseas service

Overseas, repairs shall be accepted by Mitsubishi's local overseas FA Center. Note that the repair conditions at each FA Center may differ.

## 4. Exclusion of loss in opportunity and secondary loss from warranty liability

Regardless of the gratis warranty term, Mitsubishi shall not be liable for compensation to:

- (1) Damages caused by any cause found not to be the responsibility of Mitsubishi.
- (2) Loss in opportunity, lost profits incurred to the user by Failures of Mitsubishi products.
- (3) Special damages and secondary damages whether foreseeable or not, compensation for accidents, and compensation for damages to products other than Mitsubishi products.
- (4) Replacement by the user, maintenance of on-site equipment, start-up test run and other tasks.

## 5. Changes in product specifications

The specifications given in the catalogs, manuals or technical documents are subject to change without prior notice.

## 6. Product application

- (1) In using the Mitsubishi MELSEC programmable controller, the usage conditions shall be that the application will not lead to a major accident even if any problem or fault should occur in the programmable controller device, and that backup and fail-safe functions are systematically provided outside of the device for any problem or fault.
- (2) The Mitsubishi programmable controller has been designed and manufactured for applications in general industries, etc. Thus, applications in which the public could be affected such as in nuclear power plants and other power plants operated by respective power companies, and applications in which a special quality assurance system is required, such as for railway companies or public service purposes shall be excluded from the programmable controller applications.  
In addition, applications in which human life or property that could be greatly affected, such as in aircraft, medical applications, incineration and fuel devices, manned transportation, equipment for recreation and amusement, and safety devices, shall also be excluded from the programmable controller range of applications. However, in certain cases, some applications may be possible, providing the user consults their local Mitsubishi representative outlining the special requirements of the project, and providing that all parties concerned agree to the special circumstances, solely at the user's discretion.
- (3) Mitsubishi shall have no responsibility or liability for any problems involving programmable controller trouble and system trouble caused by DoS attacks, unauthorized access, computer viruses, and other cyberattacks.

# TRADEMARKS

---

Microsoft and Windows are either registered trademarks or trademarks of Microsoft Corporation in the United States and/or other countries.

The company names, system names and product names mentioned in this manual are either registered trademarks or trademarks of their respective companies.

In some cases, trademark symbols such as <sup>™</sup> or <sup>®</sup> are not specified in this manual.





Manual number: IB(NA)-0300255ENG-F(2103)MEE

Model: FX5SSC-U-ADV-E

When exported from Japan, this manual does not require application to the Ministry of Economy, Trade and Industry for service transaction permission.

## **mitsubishi electric corporation**

HEAD OFFICE: TOKYO BUILDING, 2-7-3 MARUNOUCHI, CHIYODA-KU, TOKYO 100-8310, JAPAN  
NAGOYA WORKS: 1-14, YADA-MINAMI 5-CHOME, HIGASHI-KU, NAGOYA, JAPAN

Specifications are subject to change without notice.